



KIKUSUI

PART NO. IB032411
Jul. 2018

User's Manual

Multiple-output Regulated
DC Power Supply
PMX Series (Multiple-output)

PMX32-3DU
PMX32-3TR
PMX32-2QU

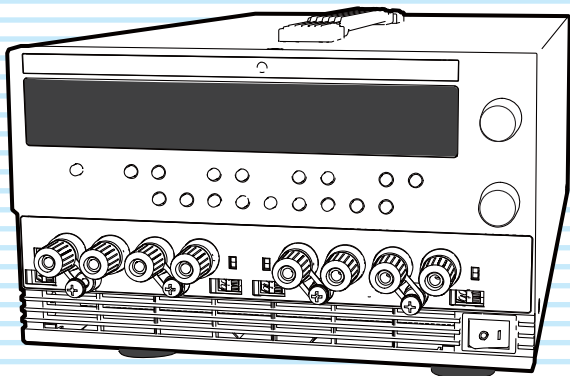

Contents 5

Component Names 8

Installation 13

Basic Functions 26

External Control 60

Parallel Operation and Series
Operation 67

Maintenance 77

Specifications 85

Appendix 96







About Manuals

These manuals provide an overview of the product and notes on usage. They also explain how to configure it, operate it, perform maintenance on it, and so on. Read these manuals thoroughly before use, and use the product properly.

Intended readers

These manuals are intended for users of this product and their instructors. The manuals assume that the reader has knowledge about power supplies.

Manual construction

- User's manual  (this manual)
This document is intended for first-time users of this product. It provides an overview of the product, notes on usage, and specifications. It also explains how to connect the product, configure the product, operate the product, perform maintenance on the product, and so on.
- Communication Interface Manual  (partially in PDF)
This document contains details about remote control. The interface manual is written for readers with sufficient basic knowledge of how to control power supplies using a PC.
- Packing list  
The packing list shows the included accessories.
- Safety Information  
This document contains general safety precautions. Keep them in mind and make sure to observe them.

PDF and HTML files are included in the accompanying CD-ROM. You can view the PDF files using Adobe Reader.

Microsoft Internet Explorer or Google Chrome is required to view the HTML files.

Firmware versions that this manual covers

This manual applies to products with firmware versions 1.0X.

For information on how to check the firmware version, see "Turning the POWER switch on" (p.21).

When contacting us about the product, please provide us with:

- The model (marked in the top section of the front panel)
- Firmware version (p.21)
- The serial number (marked on the rear panel)

Trademarks

Microsoft is a registered trademark or trademark of Microsoft Corporation in the United States and/or other countries.

Other company names and product names used in this manual are generally trademarks or registered trademarks of the respective companies.

Copyright

Reproduction and reprinting of this operation manual, whole or partially, without our permission is prohibited.

Both unit specifications and manual contents are subject to change without notice.

© Copyright 2018 Kikusui Electronics Corporation

Accessories

The attached power cord varies depending on the shipment destination.

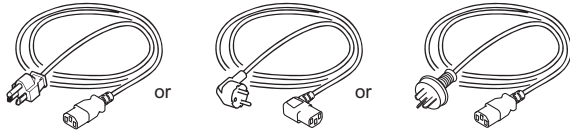

Rating: 125 Vac/10 A Plug: NEMA5-15 Length: approx. 2.5 m [85-AA-0004] or Rating: 250 Vac/10 A Plug: CEE7/7 Length: approx. 2.5 m [85-10-1070] or Rating: 250 Vac/10 A Plug: GB1002 Length: approx. 2.5 m [85-10-0791]

Power cord (1 pc.)

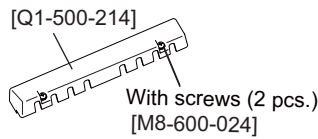

Output terminal cover set (1 set)

CD-ROM (1 disc)

Packing list (1 copy)

Safety Information (1 copy)

Product Overview

The PMX series (multiple-output) is a compact multiple-output DC power supply whose outputs are isolated from each other.

There are three models (types): two-output model (DU), three-output model (TR), and four-output model (QU). Because the PMX series comes standard with RS232C, USB, and LAN (LXI compatible) communication functions, it can easily be incorporated into a wide range of inspection systems.

It is best suitable for use in research and development and production lines.

PMX series (multiple-output) model configurations

Model	Output terminal	Rated Output Voltage	Rated Output Current	Rated Output Power
PMX32-3DU (2CH)	CH1	32 V	3 A	192 W
	CH2	32 V	3 A	
PMX32-3TR (3CH)	CH1	32 V	3 A	222 W
	CH2	32 V	3 A	
	CH3	6 V	5 A	
PMX32-2QU (4CH)	CH1	32 V	2 A	218 W
	CH2	32 V	2 A	
	CH3	18 V	2.5 A	
	CH4	18 V	2.5 A	

Features

In addition to basic constant current and constant voltage, the PMX series (multiple-output) offers a variety of other functions.

Each output isolated

Each output is isolated and safe.

High-resolution display

Display is possible with a high resolution at 1 mV or 1 mA, regardless of the output rating.

Output on/off for each channel

The output of each channel can be turned on or off, not just all channels at once.

Switch between series connection and parallel connection with a single key

CH1 and CH2 can be connected in series or parallel.

Tracking control

The output of each channel can be simultaneously changed to the same width or ratio (%).

On/off delay of each output

You can set the delay (DELAY TIME) from when the OUTPUT ALL key is turned on or off to when the output actually turns on or off. This is useful when you want to turn the output on or off by setting a delay according to the load characteristics.

Memory

You can save up to three sets of output settings (the combination of the voltage, current, OVP, OCP, on-delay, and off-delay). You can simply select a memory entry that you want to use rather than specifying the output value every time.

Simultaneous display of all channel statuses

In addition to voltage or current, output on/off and other statuses are displayed for each channel.

Sensing function

Remote sensing stabilizes the output voltage across the load by reducing the influence of voltage drops and other effects caused by the load cable resistance.

Color liquid crystal display (LCD)

Allows easy-to-see display in color. The display shows the voltage, current, operation, and status.

Standard RS232C, USB, and LAN (LXI compatible) communication functions

Simultaneous remote control is possible through the three available interfaces.

This makes it easy to incorporate the product into various inspection systems.

Notations Used in This Manual

- In this manual, the PMX32-3DU, PMX32-3TR, and PMX32-2QU multiple-output regulated DC power supplies are referred to as the PMX series (multiple-output) or the PMX.
- The term “PC” is used to refer generally to both personal computers and workstations.
- The screen captures and illustrations used in this text may differ from the actual items.
- The following markings are used in this manual.

DANGER

Indicates an imminently hazardous situation which, if ignored, will result in death or serious injury.

WARNING

Indicates a potentially hazardous situation which, if ignored, could result in death or serious injury.

CAUTION

Indicates a potentially hazardous situation which, if ignored, may result in slight injury or damage to the product or other property.

NOTE

Indicates information that you should know.



Indicates a reference manual (CD-ROM) containing detailed information.



Indicates the hierarchy of items you need to select. The item to the left of this symbol indicates a higher level item.

CFxx: x

“CF” indicates that this is a CONFIG parameter. The two digits after CF indicate the CONFIG parameter number. The value after the colon indicates the selected setting.

SHIFT+key name

Indicates an operation that requires you to press a key while holding down SHIFT.

Safety Precautions

When installing this product, be sure to observe the precautions provided in the Safety information manual. Items specific to this product are given below.

- The rear panel may become hot during operation. If you touch it, you may burn yourself.

Precautions Concerning Installation Location

When installing this product, be sure to observe the “Precautions When Choosing the Installation Location” in the Safety information manual. Items specific to this product are given below.

- When installing this product, be sure to observe the temperature and humidity ranges indicated below.
Operating temperature range: 0 °C to 40 °C
Operating humidity range: 20 %rh to 85 %rh (no condensation)
- When storing this product, be sure to observe the temperature and humidity ranges indicated below.
Storage temperature range: -25 °C to 70 °C
Storage humidity range: 90 %rh or less (no condensation)
- Do not install the product vertically.
It may cause injury to the operator or damage to the product when it falls down.

Contents

About Manuals	2
Accessories	3
Product Overview	3
Notations Used in This Manual.....	4
Safety Precautions	4
Precautions Concerning Installation Location	4
Component Names	8

Installation

Connecting the Power Cord	13
Load Considerations	14
Selecting the Load Cables	16
Output Terminal Insulation	17
When the output terminal is not grounded (floating). 17	
When the output terminal is grounded.....	18
Connecting to the Output Terminals.....	19
Checking Whether the Power Is On or Off	21
Turning the POWER switch on.....	21
Turning off the POWER switch.....	22
Sensing Function.....	23
Local sensing.....	23
Remote sensing.....	23

Basic Functions

Panel Display	26
Panel Operations.....	28
Output Operation	29
Output on/ off setting at power-on	29
Output-on startup state parameter	29
output-on delay/ off delay	30
CV Power Supply and CC Power Supply	34
Using the PMX as a CV or CC Power Supply	36
Protection Functions and Alarms.....	37
Alarm occurrence and clearing alarms	37
Setting and displaying the protection functions	38
CONFIG Settings	42
CONFIG parameter details.....	45
Memory Function.....	52
Saving settings	52
Recalling settings	53

Locking the Panel Controls (Key Lock)	54
Tracking Function.....	54
Remote Control	59

External Control

CONTROL TERMINAL	61
Connecting the CONTROL TERMINAL	61
Pin arrangement of the CONTROL TERMINAL ...	62
Output On/Off Control	63
Alarm Input.....	65
External monitoring of the operating status.....	66

Parallel Operation and Series Operation

Overview of Parallel Operation	67
Parallel Operation Functions.....	67
Connections for parallel operation.....	69
Configuration for parallel operation	70
Starting parallel operation	70
Overview of Series Operation	72
Series Operation Functions.....	72
Connection for series operation	74
Configuration for series operation	75
Starting series operation	75

Maintenance

Calibration Overview	77
Connection	78
Calibration procedure	79
Connection (series operation and parallel operation) 82	
Calibration procedure (series operation and parallel operation)	83

Specifications

AC input	85
Output	86
Display function	88
Protection function	89
Signal output	89
Control functions	90
Sensing	90
Parallel operation and series operation	91
Other functions	92
Interface	93
General specifications	94
External dimensions	95

Appendix

Factory Default Settings	96
Options	97
Rack mounting options	97
Troubleshooting	99
Index	103



This page is intentionally blank.

Component Names

Front panel

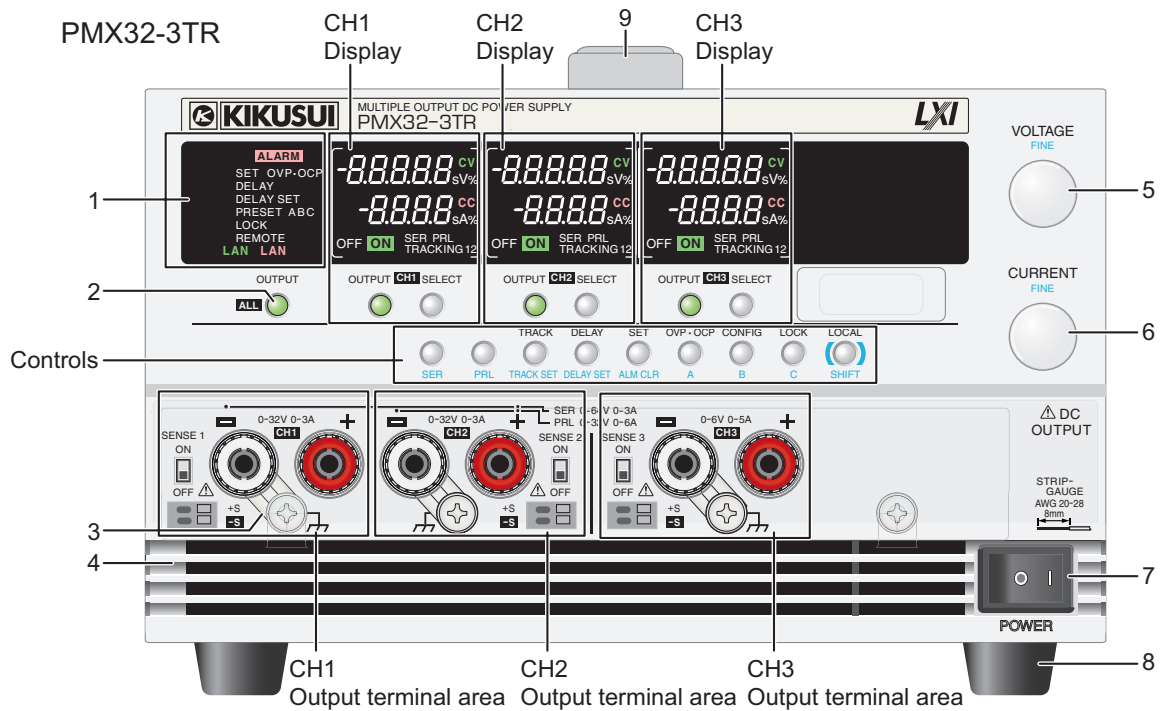
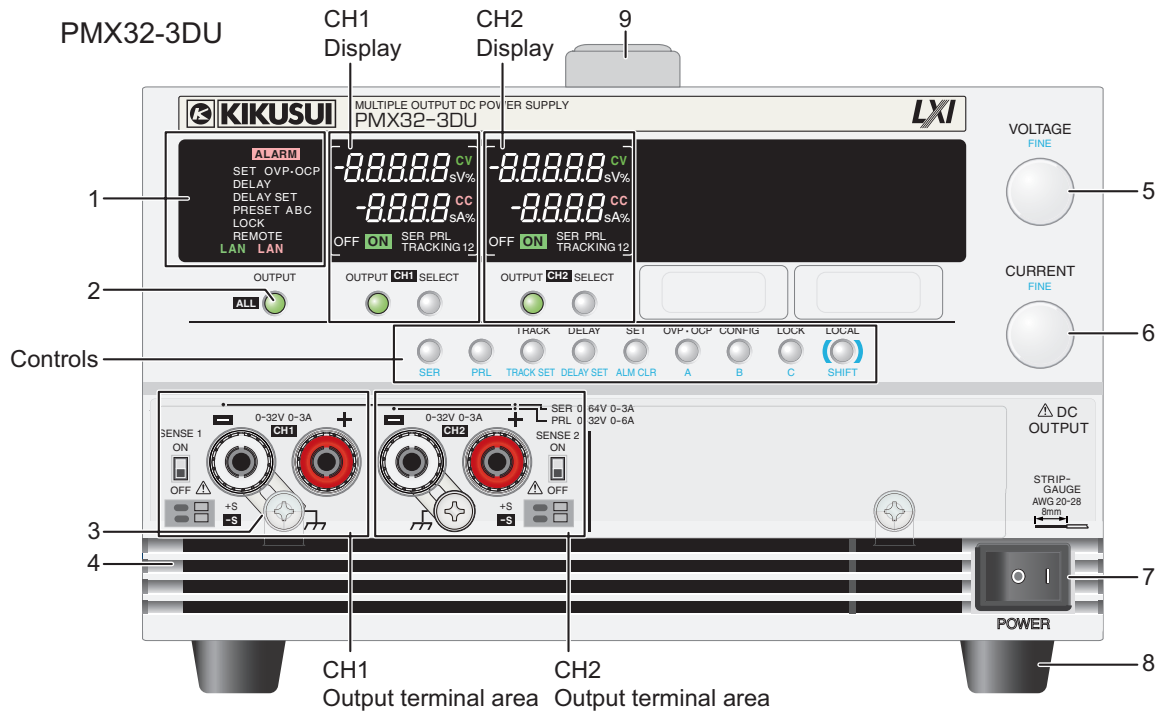

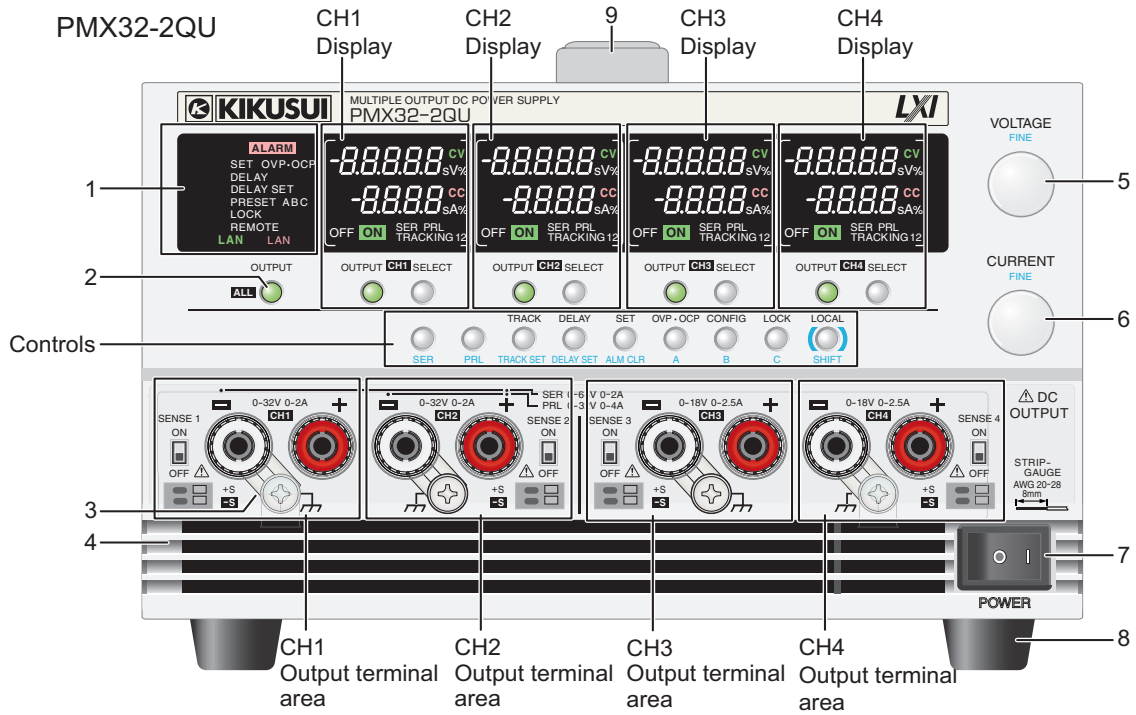

No.	Name	Function	See
1	Status display area	<p>ALARM: Appears in red when a protection function is activated.</p> <p>SET: Appears when setting or viewing the output voltage or output current.</p> <p>OVP•OCP: Appears when the overvoltage protection (OVP) or overcurrent protection (OCP) trip point is being set.</p> <p>DELAY: Appears when output-on delay/ off delay is in progress. Blinks when delay is in progress.</p> <p>DELAY SET: Appears when output-on delay/ off delay is being set.</p> <p>PRESET A/ B/ C: Appears when memory A, B, or C is being recalled or saved.</p> <p>LOCK: Appears when the key lock is enabled.</p> <p>REMOTE: Appears when the product is being controlled remotely.</p> <p>LAN (green): Appears in the no fault state. Blinks in the identify state.</p> <p>LAN (red): Appears in the fault state. Blinks in the standby state.</p>	—
2	OUTPUT ALL key	Turns the output on or off on all channels simultaneously. Starts the output-on delay/ off delay.	p.29
3	Short bar	Connects the output terminal to the chassis terminal.	—
4	Air inlet	Inlet holes for cooling.	—
5	VOLTAGE knob	Used to set the voltage value or change the value of a CONFIG parameter.	p.28
	FINE	Used to make fine voltage value adjustments.	p.28
6	CURRENT knob	Used to set the current value or change the value of a CONFIG parameter.	p.28
	FINE	Used to make fine current value adjustments.	p.28
7	POWER switch	Press the (I) side to switch the power on, and the (O) side to switch the power off.	p.21
8	Feet	Four casters attached to the bottom of the product.	p.98
9	Handle	Handle for carrying the product.	p.98

CH1/CH2/CH3/CH4 display area

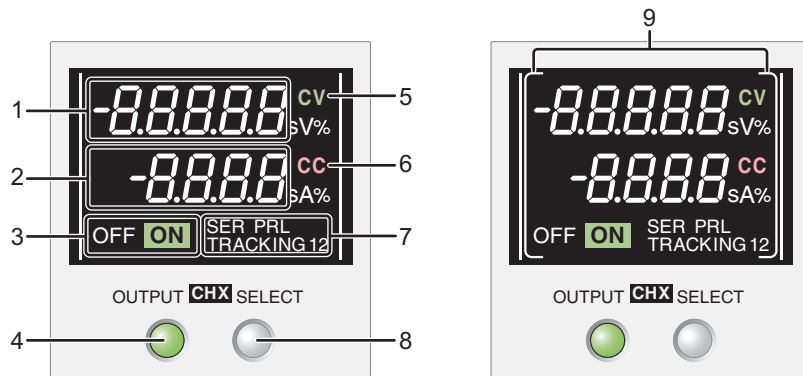

No.	Name	Function	See
1	Voltmeter	Displays the voltage, CONFIG parameter number, alarm, output-on delay time, or the amount of voltage change of tracking function 2.	p.26
2	Ammeter	Displays the current, CONFIG parameter value, cause of alarms, output-off delay time, or the amount of current change of tracking function 2.	p.26
3	Output display	OFF: appears when output is off, ON: appears when output is on (green)	p.29
4	OUTPUT key	Turns on or off the output of each channel.	p.29
5	CV	Appears in constant voltage mode.	p.36
6	CC	Appears in constant current mode.	p.36
7	Status indicators	SER: Appears during series operation. PRL: Appears during parallel operation. TRACKING12: Appears when tracking function 1 or tracking function 2 is in use.	— p.54
8	SELECT key	Selects the channel.	—
9	Selection display	Appears when selected with the SELECT key.	—

Control area and output terminal area

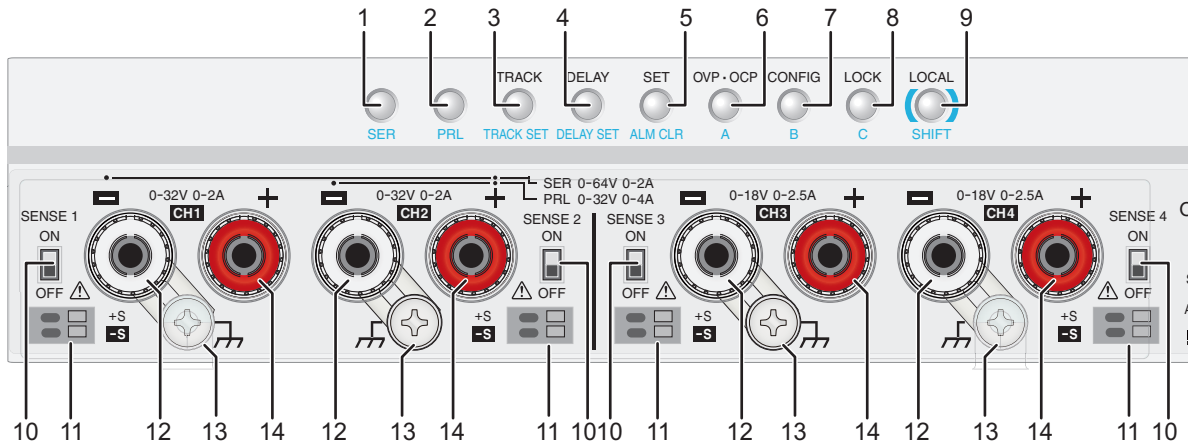

No.	Name	Function	See
1	SER key	Turns on or off parallel operation.	p.75
2	PRL key	Turns on or off series operation.	p.70
3	TRACK key	Turns on or off the tracking function.	p.54
	TRACK SET key	Switches between tracking function 1 and tracking function 2.	p.54
4	DELAY key	Turns on or off the delay function.	p.33
	DELAY SET key	Used to set or display the output-on delay/ off delay time.	p.32
5	SET key	Used to set or display the output voltage or output current.	p.26
	ALARM CLR key	Releases the activated state (alarm) of protection functions.	p.37
6	OVP·OCP key	Used to set or display the overvoltage protection (OVP) or overcurrent protection (OCP) trip point.	p.38
	A	Recalls or saves memory A values.	p.52
7	CONFIG key	Used to configure various operating conditions (CONFIG).	p.42
	B	Recalls or saves memory B values.	p.52
8	LOCK key	Turns on or off the key lock.	p.54
	C	Recalls or saves memory C values.	p.52
9	LOCAL key	Switches between local mode and remote mode.	p.59
	SHIFT key	Used to enable the functions that are written in blue characters below the key.	—
10	SENSE switch	Used to turn remote sensing on and off.	p.23
11	Sensing terminal	Terminals to connect the sensing cables to.	p.24
12	DC OUTPUT-	Negative output terminal	p.19
13	Chassis terminal	A connector for grounding the output.	—
14	DC OUTPUT+	Positive output terminal	p.19

Rear Panel

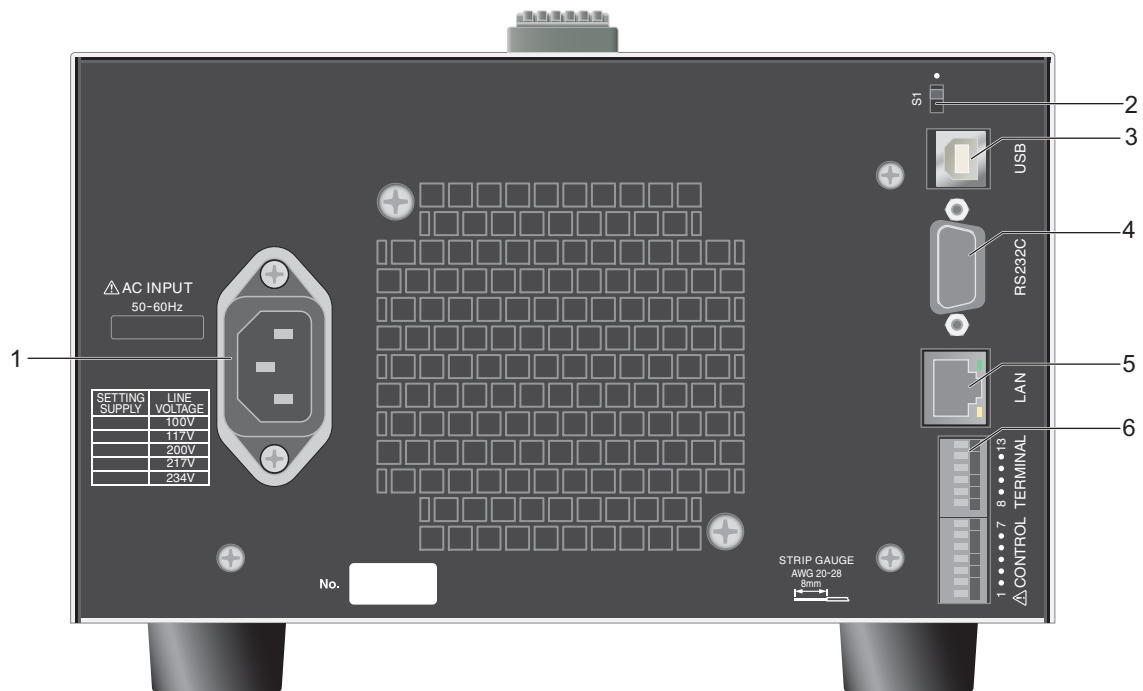

No.	Name	Function	See
1	AC INPUT	AC inlet	p.13
2	S1 switch*1	Maintenance switch.	—
3	USB port	USB port for remote control.	 MANUAL Interface manual
4	RS232C port	RS232C port for remote control.	
5	LAN port	LAN port for remote control.	
6	CONTROL TERMINAL	External control terminal block.	p.61

*1. Kikusui service engineers use this switch only during maintenance and servicing. Normally, the switch is on the side of ●.

Installation

Connecting the Power Cord

This product is designed as an equipment of IEC Overvoltage Category II (energy-consuming equipment supplied from a fixed installation).

Protective conductor current (at 257.4 Vac, 60 Hz) : Approx. 1 mA.

⚠ WARNING Risk of electric shock.

- This product is IEC Safety Class I equipment (equipment with a protective conductor terminal). To prevent electric shock, be sure to connect the protective conductor terminal of the product to electrical ground (safety ground).
- The product is grounded through the power cord ground wire. Connect the protective conductor terminal to earth ground.

NOTE

- Use the supplied power cord to connect to the AC line. If the supplied power cord cannot be used because the rated voltage or the plug shape is incompatible, have a qualified engineer replace it with an appropriate power cord that is 3 m or less in length. If obtaining a power cord is difficult, contact your Kikusui agent or distributor.
- The power cord with a plug can be used to disconnect the product from the AC power line in an emergency.
- Secure adequate space around the power plug. Do not insert the power plug to an outlet where accessibility to the plug is poor. And, do not place objects near the outlet that would result in poor accessibility to the plug.
- Do not use the supplied power cord with other instruments.

1 Check that the AC power line meets the nominal input rating of the product.

The product can receive a nominal power supply voltage of 100 Vac, 117 Vac, 200 Vac, 217 Vac, or 234 Vac at a frequency of 50 Hz or 60 Hz.

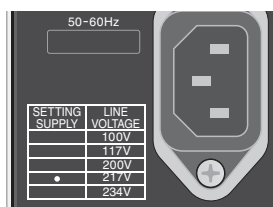

The supply voltage is set before factory shipment by a Kikusui service engineer. A mark is indicated to the left of the appropriate voltage.

Be sure to check the nominal input rating before connecting the power cord.

Example of 217 Vac supply voltage

2 Turn the POWER switch off (O).

3 Connect the power cord to the AC INPUT inlet on the rear panel.

4 Connect the power cord plug to an outlet with a ground terminal.

This completes the connections.

Load Considerations

Note that the output will become unstable if the following types of loads are connected.

Loads with peak current or pulse-shaped current

The product only indicates mean values. Even when the indicated value is less than or equal to the set constant current, the peak values may exceed the set constant current. If this happens, the product is instantaneously put into constant-current mode, and the output voltage drops.

For these types of loads, you must increase the set constant current or increase the current capacity.

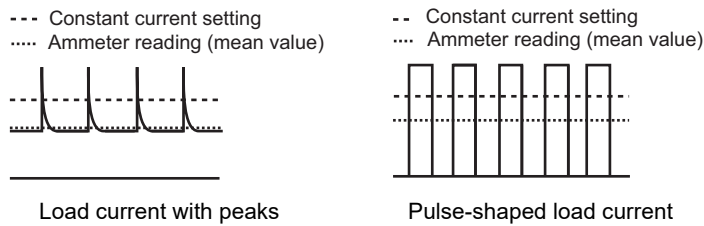

Loads that generate reverse current to the power supply

The product cannot absorb reverse current from the load. Therefore, if a regenerative load (such as an inverter, converter, or transformer) is connected, the output voltage increases and becomes unstable. This can cause a malfunction.

For these types of loads, connect a resistor (R_D) as shown in the following figure to bypass the reverse current. However, the amount of current to the load decreases by I_{rp} .

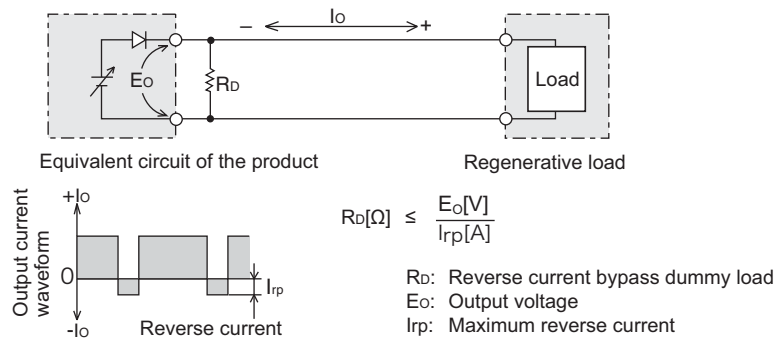

CAUTION

Use a resistor with sufficient rated power for R_D . If a resistor with insufficient rated power for the circuit is used, resistor R_D will burn out.

Loads with accumulated energy

Connecting a load with accumulated energy, such as a battery, to the product may cause current to flow from the load to the internal circuit of the product. This current may damage the product or reduce the life of the load.

For this type of load, connect a reverse-current-prevention diode (DRP) between the product and the load in series as shown in the following figure.

This cannot be used in conjunction with remote sensing.

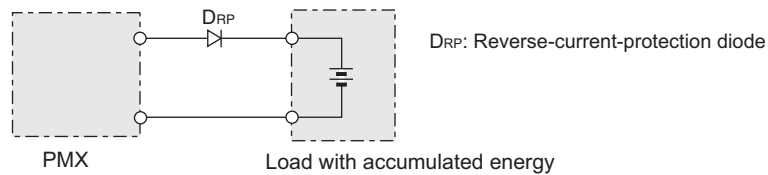

CAUTION

- To protect the load and the product, use a DRP that conforms to the following specifications.

Reverse voltage withstand capacity: At least twice the rated output voltage of the product.

Forward current capacity: 3 to 10 times the rated output current of the product.

A diode with small loss.

- Be sure to take into account the heat generated by DRP. DRP will burn out with inadequate heat dissipation.

Sink current from an external voltage source

The current varies depending on the voltage of the external voltage source.

The sink current is reduced at a low output terminal voltage. Hardly any sink current flows near 0 V.

The sink current indicated here is the value obtained when an external voltage with the same value as the rated voltage is connected.

■ Sink current (TYP)

Model	CH1	CH2	CH3	CH4
PMX32-3DU	43 mA	43 mA	-	-
PMX32-3TR	43 mA	43 mA	27 mA	-
PMX32-2QU	43 mA	43 mA	36 mA	36 mA

Selecting the Load Cables

WARNING

Risk of fire.

- Use load cables whose capacity is adequate for the product's rated output current.
- The output connector and its surrounding area become hot. Use cables whose covers have heat resistance at 85 °C and higher.

Risk of electric shock.

- Use load cables with a voltage rating that meets or exceeds the product's isolation voltage. For details on the product's isolation voltage, see 「Specifications」 (p.85).

CAUTION

- Use load cables with a core diameter that is appropriate for the amount of current being used and with sturdy, flame-resistant insulation.

■ Current capacity of load cables

A wire's temperature is determined by the resistive loss based on the current, the ambient temperature, and the wire's external thermal resistance. The following table shows the current capacity of heat-resistant vinyl wires that have a maximum allowable temperature of 60 °C when one of the wires is separated and stretched out horizontally in air in an ambient temperature of 30 °C. The current must be reduced under certain conditions, such as when vinyl wires that have a low heat resistance are used, when the ambient temperature is 30 °C or greater, or when wires are bundled together and little heat is radiated.

Nominal cross-sectional area (mm ²)	AWG (reference cross-sectional area; mm ²)	Allowable current* ¹ (A) (Ta = 30°C)	Kikusui-recommended current (A)
0.9	18 (0.82)	17	4
1.25	16 (1.31)	19	6
2	14 (2.08)	27	10
3.5	12 (3.31)	37	-
5.5	10 (5.26)	49	20

*1. * Excerpt from Japanese laws related to electrical equipment.

■ Taking measures against noise

When connecting wires that have the same heat resistance, separating the wires as much as possible to increase heat radiation enables a greater amount of current to flow. However, wiring the + (positive) and - (negative) output wires of the load cable side by side or bundling them together is more effective against unwanted noise. The Kikusui-recommended currents shown in the above table are allowable currents that have been reduced in consideration of the potential bundling of load cables. Use these values as a guideline when connecting load cables.

■ Limitations of the remote sensing function

All wires have resistance. As the wire becomes longer or the current becomes larger, the voltage drop in the wire becomes greater. This results in a smaller voltage being applied at the load end. This product has a sensing function that compensates for this voltage drop up to approximately 0.6 V for a single line (p.23). If the voltage drop exceeds this level, use wires that have a greater cross-sectional area.

Output Terminal Insulation

⚠ WARNING Risk of electric shock. For safety reasons, even if the output terminal is grounded, make sure that the insulation capacity of the output terminal (including the sensing terminal) is greater than or equal to the isolation voltage of this product. For details on the isolation voltage of each model, see 「Specifications」 (p.85). If you cannot obtain a cable with sufficient rated voltage, secure adequate withstand voltage by passing the cable through an insulation tube with a withstand voltage greater than the isolation voltage of the PMX seres (multiple-output).

The cable and load that are connected to the output terminal (including the sensing terminal) must have an insulation capacity that is greater than or equal to the isolation voltage of the PMX seres (multiple-output) with respect to the chassis. Isolation voltage indicates the maximum allowed voltage that appears across the output terminal of the power supply unit and the protective conductor terminal (chassis terminal).

When the output terminal is not grounded (floating)

The output terminal of the PMX seres (multiple-output) is isolated from the protective conductor terminal. If you connect the GND wire of the power cord to the ground terminal of the switchboard, the chassis of the product is set to ground potential.

Pins 1 to 7 of the CONTROL TERMINAL on the rear panel are isolated from the chassis terminal and output terminal of this product. Cables and devices that are connected to these pins must have an insulation capacity greater than or equal to the isolation voltage of the PMX seres (multiple-output).

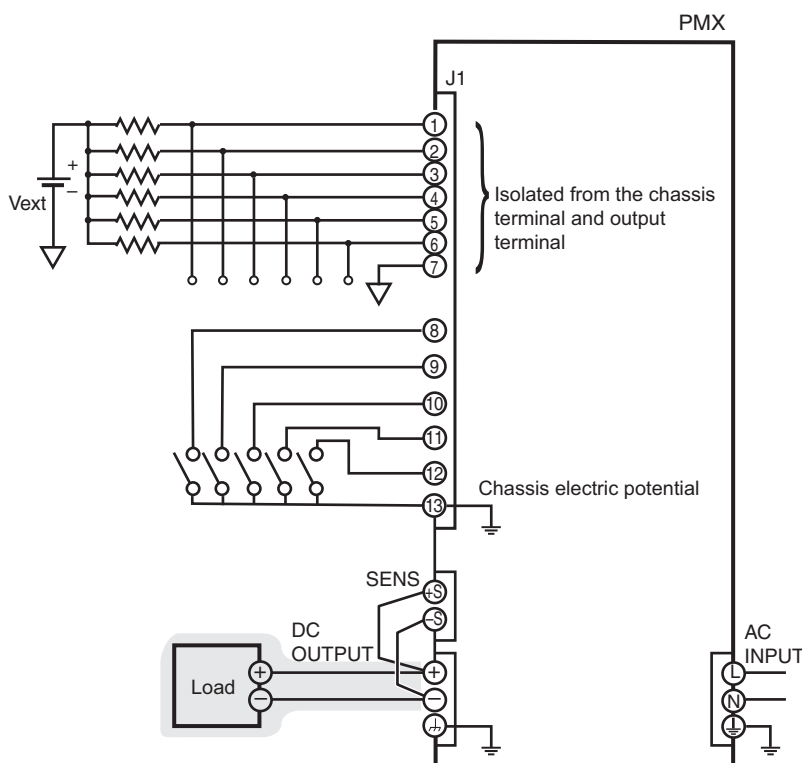

When the output terminal is grounded

If the positive output terminal is connected to the chassis terminal, the positive output terminal is at ground potential. The cable and load that are connected to the output terminal (including the sensing terminal) will only require an insulation capacity that is greater than or equal to the maximum output voltage of the PMX series (multiple-output) with respect to the chassis.

The same holds true when the negative terminal is connected to the chassis terminal. The cable and load require an insulation capacity that is greater than or equal to the maximum output voltage of the PMX series (multiple-output).

For safety reasons, connect one of the output terminals to the chassis terminal unless your application requires the output terminals to be floating.

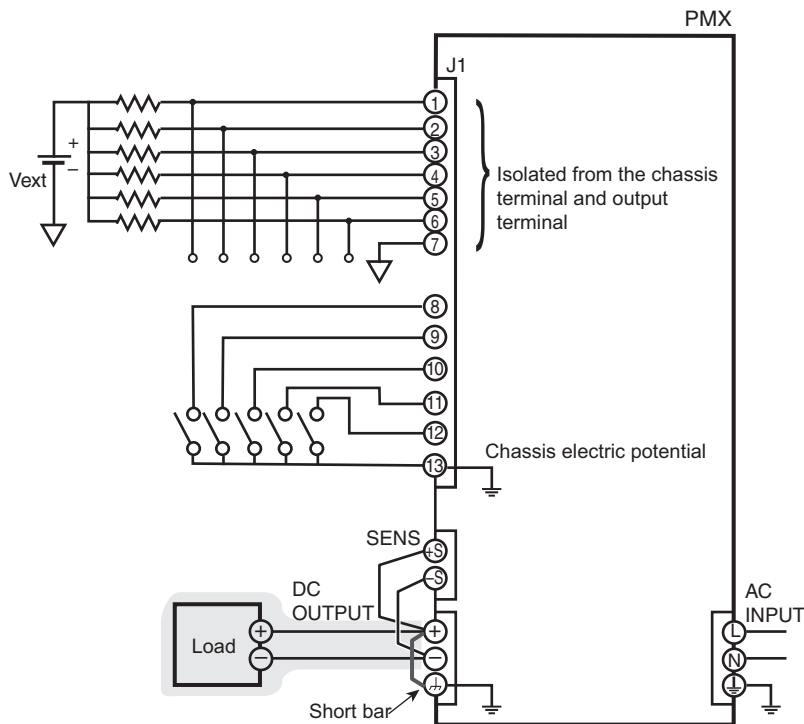

Connecting to the Output Terminals

⚠ WARNING Risk of electric shock.

- Turn the **POWER** switch off before you touch the output terminals.
- Regardless of whether load cables are connected to the output terminals, be sure to attach the output terminal cover before turning the **POWER** switch on.

When using the sensing function, connect the sensing cables before connecting the load cables to the output terminals.

- 1** Turn the **POWER** switch off.
- 2** Attach crimping terminals to the load cables.
- 3** Remove the knobs once, and attach the load cables to the output terminals.

Connect the short bar to the negative or positive output terminal.

If you are not grounding the output terminal (leaving it floating), follow the instructions in see “When the output terminal is not grounded (floating)” on page 17 before use.

To reduce the influence of noise on the output, keep the cables as short as possible. If possible, twist the positive and negative load cables.

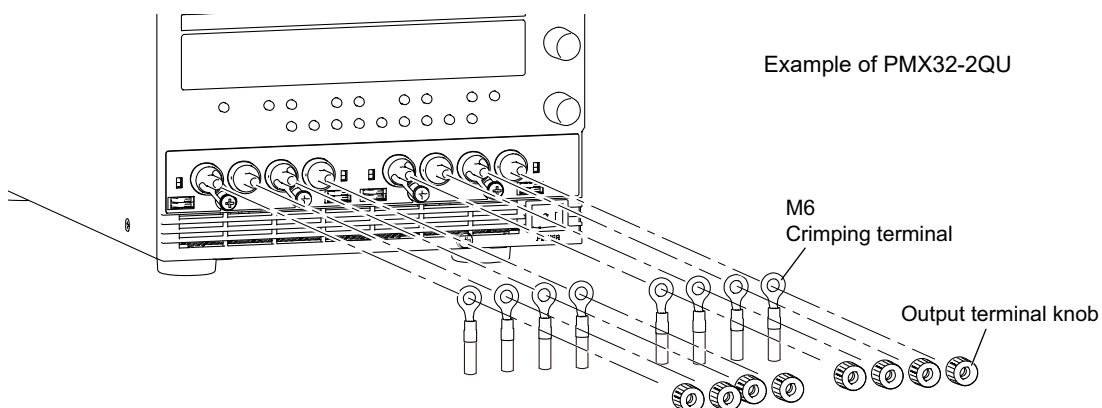

- 4** To attach the output terminal cover, remove the chassis terminal screws on the outside.

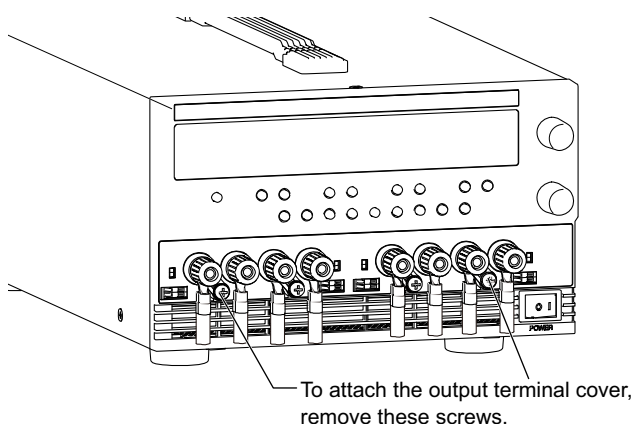

5 Attach the output terminal cover.

Attach the output terminal cover using the screws included with the output terminal cover.

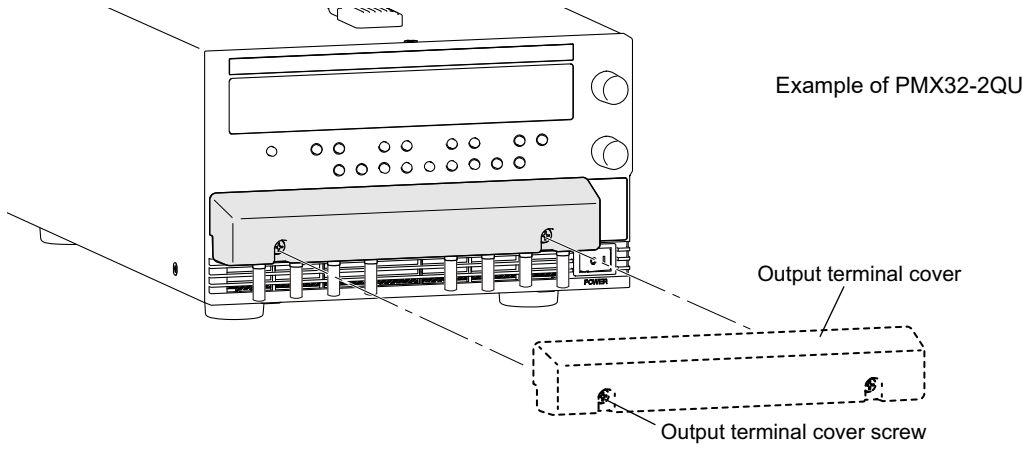

This completes the connections.

Checking Whether the Power Is On or Off

Turning the POWER switch on

⚠ WARNING Risk of electric shock. Regardless of whether load cables are connected to the output terminals, be sure to attach the output terminal cover before turning the POWER switch on.

⚠ CAUTION Risk of damage to load. If the product is configured to turn on the output when the POWER switch is turned on in CONFIG settings, set an appropriate OVP or OCP value before connecting a different load.

If the POWER switch is turned on for the first time after purchase, the product starts in the factory default condition (p.96). Subsequent times that you turn the product on, it starts with the panel settings (excluding the output on/off setting) that were in use immediately before the POWER switch was turned off.

You can use the CONFIG settings (CF01) to select the output state of the product when the POWER switch is turned on (p.45).

1 Check that the power cord is connected correctly.

2 Check that the output terminal cover is attached (p.19).

When the product is shipped from the factory, the output terminal cover is not attached.

3 Turn the POWER switch on (I).

All the indicators on the front panel turn on, and then the CH2 voltmeter and ammeter display the following information in sequence: the rated voltage, rated current, and type, the firmware version number, and then the build number. Each item is displayed for approximately 1 second.

After a few seconds, the product enters the operation standby state (the measured value is displayed).

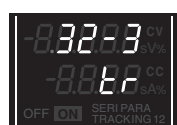

Rated voltage, rated current, and type
(Example of PMX32-3TR)

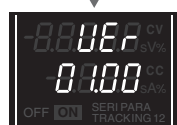

Firmware version
(Version 1.00 in this example)

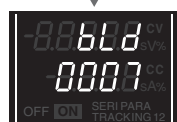

Build number
(Build number BLD 0007 in this example)

■ Inrush current

When the POWER switch is turned on, an inrush current flows. Check that sufficient current capacity is available in the AC power line or the switchboard, particularly if you are using multiple units and turning on their POWER switches simultaneously. For the inrush current of each model, see “Specifications” (p.85).

Turning off the POWER switch

Turn the POWER switch off (O).

This product saves the panel settings (except the output on/off setting) that were in use immediately before the POWER switch was turned off.

You can use the CONFIG settings (CF01) to select the output state of the product when the POWER switch is turned on (p.45).

If the POWER switch is turned off immediately after the settings have been changed, the last settings may not be stored.

CAUTION

If you want to turn the POWER switch back on, wait at least 10 seconds after the panel display turns off. Repeatedly turning the POWER switch on and off at short intervals can cause damage to the internal circuit. Furthermore, this will shorten the service life of the POWER switch and the internal input fuse.

In some cases, the keys may become uncontrollable or a malfunction may occur in the alarm indicators or the like. Turn the POWER switch off once and then back on.

Sensing Function

There are two types of sensing: local sensing and remote sensing.

By factory default, the product is set to local sensing (the SENSE switch is set to off).

Local sensing

Use local sensing when the cable to the load is short.

Local sensing does not compensate for the voltage drop in the load cable, so use this method when the load current is small or when you do not need to consider the load regulation voltage.

The sensing point during local sensing is the output terminal.

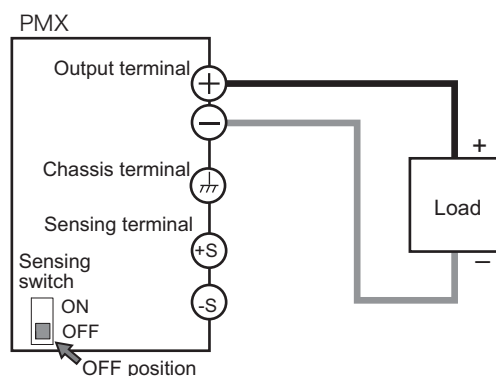

Remote sensing

Use remote sensing when the cable to the load is long.

Remote sensing is a function that stabilizes the output voltage across the load by reducing the influence of voltage drops and other effects caused by the load cable resistance.

You can use the product remote sensing feature to compensate up to 0.6 V for a single line. Select a load cable that has sufficient current capacity to prevent the voltage drop in the load cable from exceeding the compensation voltage.

When you perform remote sensing, keep the output terminal voltage from exceeding the rated output voltage. If you are performing remote sensing with the voltage close to the maximum output voltage, the output is limited by the maximum output voltage (105 % of the rated output voltage). Electrolytic capacitors may be required at the sensing point (across the load).

To reduce the effect of noise, use twisted-pair cables or 2-core shielded cables. When you use shielded cables, connect the shield to the product or the load grounding terminal.

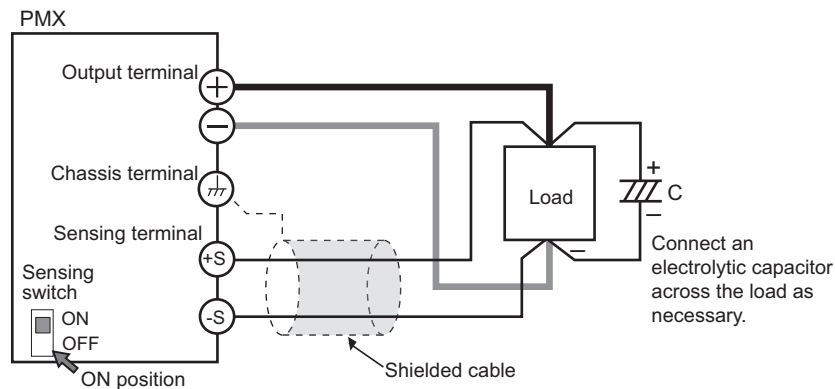

Connecting the sensing cables

- ⚠ WARNING**
- **Never wire the sensing terminals while the POWER switch is turned on.**
 - **For sensing cables, use cables with a voltage rating that is higher than the product's isolation voltage. Protect the uncovered sections of the shielded cable by using insulation tubes whose withstand voltage is greater than the product' isolation voltage.**
 - **Insert the cables so that the wire strands do not touch the chassis when they stick out of the sensing terminal. Also, insert the cables so that the stripped wires do not stick out of the terminal.**
- Be sure to attach the output terminal cover before turning the POWER switch on.**

When using the sensing function, connect the sensing cables before connecting the load cables to the output terminals.
 If the sensing cables come loose, the output voltage will fluctuate. Because it may increase several tens of volts higher than the specified value, be sure to set an appropriate OVP trip point.
 If you are not going to use remote sensing, return the product to local sensing mode.

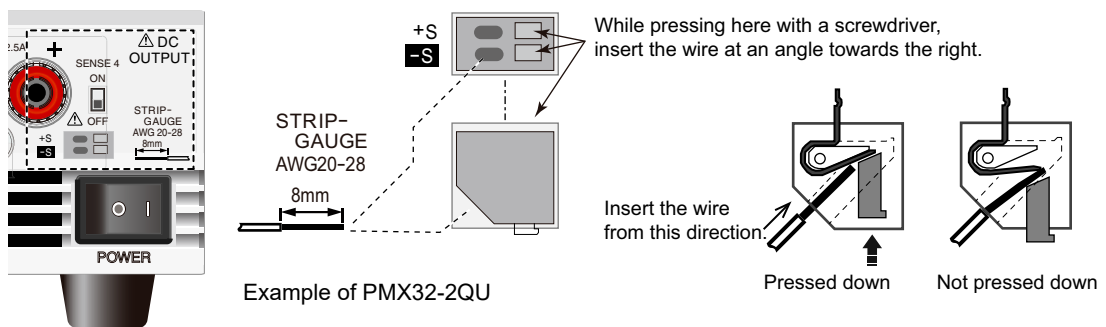

- 1 Turn the POWER switch off.**
- 2 Remove 8 mm of the wire covering. Connect the negative sensing cable to -S that will be used for remote sensing and the positive sensing cable to +S.**
 Insert the sensing cable towards the right according to the angle of the sensing terminal.
- 3 Turn on the SENSE switch on the front panel.**

- 4** Pull out the sensing wires from the side of or from below the output terminal cover, and attach the output terminal cover.

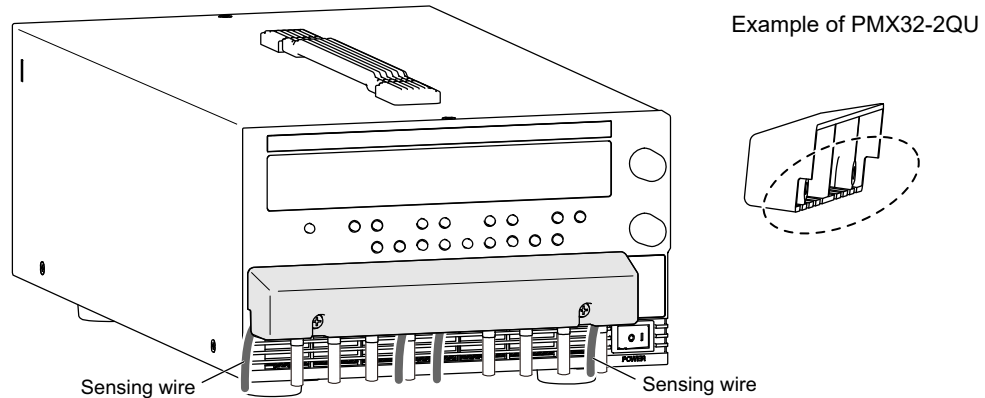

This completes the connections.

Electrolytic capacitor to connect across the load

If the wiring inductance component is large, the following symptoms may appear.

- Oscillation

If the wires used to connect to the load are long, the wiring inductance and capacitance can cause phase shifting at a level that cannot be ignored. This may lead to oscillation.

- Output fluctuation

If the load current changes drastically in a pulse-shaped pattern, the output voltage may become large due to the wiring's inductance component.

You can reduce the inductance component by twisting the load cables, which stabilizes the voltage. However, if this does not correct the problem, connect an electrolytic capacitor across the load.

Electrolytic capacitor to use

Capacitance: 0.1 μF to several 100 μF

Withstanding voltage: At least 120 % of the rated output voltage of the product

■ If you are inserting a mechanical switch between the product and the load

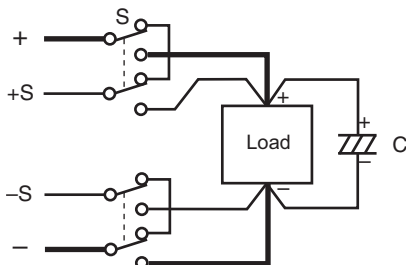

If you want to connect and disconnect the load using a mechanical switch that is inserted between the product and the load, be sure to include switches in the sensing cables as shown in the following figure and turn on and off the load cable and the sensing cables simultaneously. Before you turn the mechanical switch on or off, be sure to turn off the OUTPUT key.

Basic Functions

Panel Display

The voltage and current displays have the following two states.

- Measurement display
- Setting display

In addition to voltage and current, the display area shows the OVP/OCP value, system configuration settings, alarms, output-on delay/ off delay time, tracking, and SCPI communication errors (when CF23 is set to 00).

Select the channel that you want to configure by pressing the SELECT key. Brackets “[]” appear in the display area of the selected channel.

Items that can be set separately for each channel are shown in the display area of each channel, and items common to all channels or items set to the same value for all channels are shown in the display area of CH2.

SCPI communication errors are also shown in the display area of CH2 (when CF23 is set to 00).

Measurement display

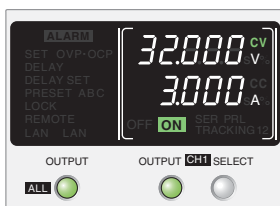

The present output voltage and output current are displayed. The “SET” indicator in the display area is off. If the outputs of all channels are set off and you turn the VOLTAGE or CURRENT knob, the “SET” indicator appears, and the setting display appears.

Setting display

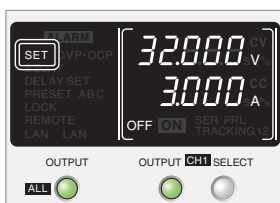

When you press SET, the “SET” indicator appears in the display area, and the present output voltage and output current settings are displayed.

When you press SET again, the “SET” indicator disappears, and the measurement display appears.

Overvoltage protection and overcurrent protection setting display

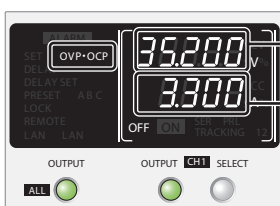

OVP
Trip
point
OCP
Trip
point

When you press OVP•OCP, the “OVP•OCP” indicator appears, and the present overvoltage protection (OVP) and overcurrent protection (OCP) settings are displayed.

When you press OVP•OCP again, the “OVP•OCP” indicator disappears, and the measurement display appears.

System configuration setting display

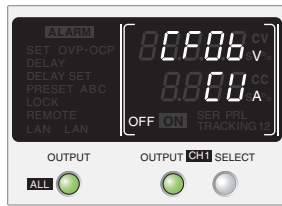

When you press CONFIG, the present system configuration settings are displayed.

Parameters set to the same value for all channels are shown in CH2. For items that can be set separately for each channel, the same parameter number is displayed for all channels.

Alarm display

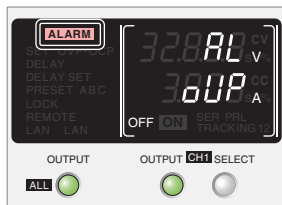

When an alarm is activated by a protection function, the "ALARM" indicator (red) and the cause of the alarm are displayed.

Panel Operations

Measurement display, setting display, and OVP/OCP value display

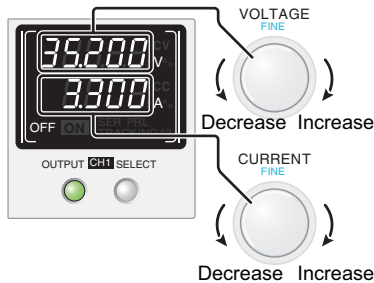

Select the channel that you want to configure by pressing the SELECT key.

Turn the VOLTAGE knob to change the voltage. Turn the CURRENT knob to change the current.

If the outputs of all channels are set off and you turn the VOLTAGE or CURRENT knob, the setting display appears, and you can change the values. When the output is on, you can press SET to switch to the setting display, and then change the output while you view the actual voltage or current settings.

■ Fine adjustment (FINE)

You can change the resolution of the VOLTAGE and CURRENT knobs. Hold down SHIFT while you turn the VOLTAGE knob or CURRENT knob to make small changes to the value (FINE mode).

The following table shows the resolutions that can be specified. The specified resolution may not necessarily be applied to the actual output.

- Output voltage setting resolution

		PMX32-3DU	PMX32-3TR	PMX32-2QU
Resolution	CH1	100 mV	100 mV	100 mV
	CH2	100 mV	100 mV	100 mV
	CH3	–	20 mV	100 mV
	CH4	–	–	100 mV
FINE mode		1 mV	1 mV	1 mV

- Output current setting resolution

		PMX32-3DU	PMX32-3TR	PMX32-2QU
Resolution	CH1	10 mA	10 mA	10 mA
	CH2	10 mA	10 mA	10 mA
	CH3	–	20 mA	10 mA
	CH4	–	–	10 mA
FINE mode		0.1 mA	0.1 mA	0.1 mA

Output Operation



The output turns on and off each time that you press OUTPUT. When the output is on, the “ON” indicator (green) appears in the display area. When the output is off, the “OFF” indicator appears.

An OUTPUT key is available for each channel. You can turn on or off the output of each channel by pressing the OUTPUT key of each channel. You can control the output of all channels simultaneously using the OUTPUT ALL key. If the output on/off state of each channel is different, the output of all channels will be turned off once, and then all the channels will be controlled simultaneously.

When the output is on, output is generated at the present set values.

If you change the settings while the output is on, the changes are applied almost immediately to the output. If the output of all channels is off, the setting display will appear (the “SET” indicator will appear) as soon as you change a value.

You can set the rise time (speed) that is applied when you change a value. Using CONFIG setting CF07, select 100 ms (CF07: 5L0H) or 10 ms (CF07: FR5E) (p.46). (The factory default setting is 100 ms.)

You can use external control to turn the output on and off (p.63).

Output on/ off setting at power-on

By factory default, the product starts with the output turned off when the power is turned on. Using CONFIG setting CF01, you can set the output state at power-on (p.45).



If the output is set so that it is on at power-on, be sure to check the OVP and OCP trip point settings (p.38 , p.39) before you turn off the POWER switch. If the OVP or OCP trip point is not set properly when the load is changed, the load could be damaged.

Output-on startup state parameter

You can set whether to start in CC mode or CV mode when the output is turned on. Using CONFIG parameter CF06, select prioritize CV (CF06: 11) to start the product as a constant voltage (CV) power supply or prioritize CC (CF06: 12) to start the product as a constant current (CC) power supply (p.46). (The factory default setting is prioritize CV.)

Output-on delay/ off delay

You can set a delay from when the OUTPUT ALL key is pressed to when the output actually turns on or off. This is a useful function when you want to turn the output on or off by setting a delay according to the load characteristics.

When set, "DELAY SET" appears in the display area. When in operation, "DELAY" appears.

During the delay time until the output turns on or off, the "DELAY" indicator blinks in the display area.

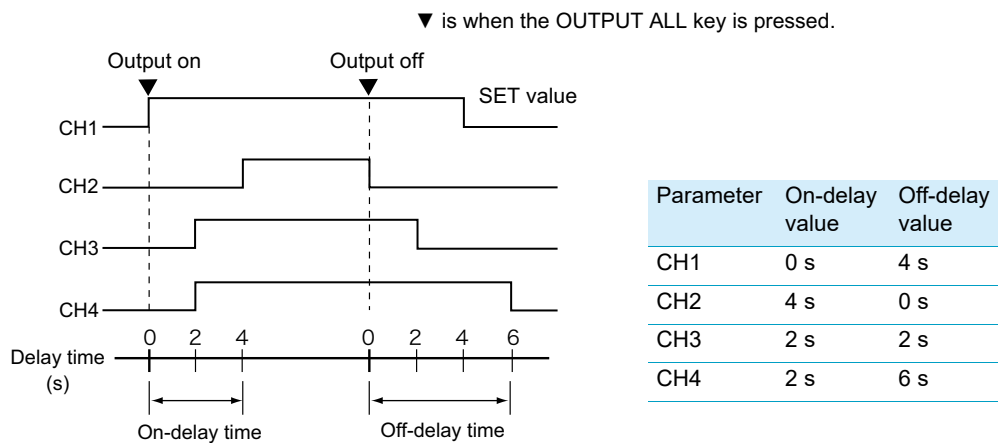
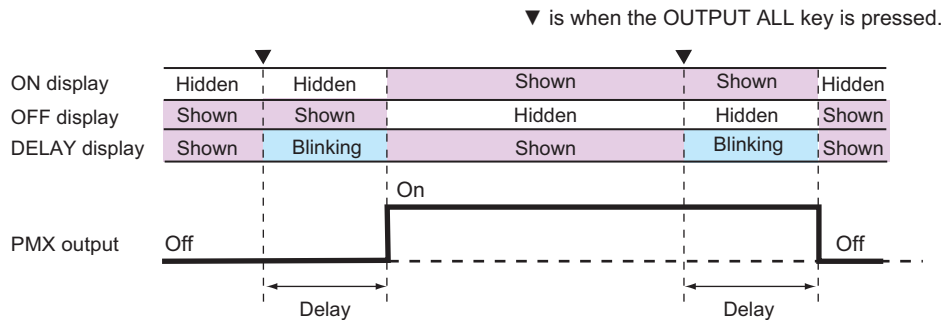

If you press DELAY while the “DELAY” indicator is blinking, the output-on delay/ off delay operation is canceled, and the output of all channels is turned off. If you want to resume the output-on delay/ off delay operation, press DELAY (the “DELAY” indicator appears).

If you press DELAY when the output of all channels is on after an output-on delay operation, the delay function will be cleared. If you press OUTPUT ALL in this condition, the output of all channels is turned off without an off-delay operation.

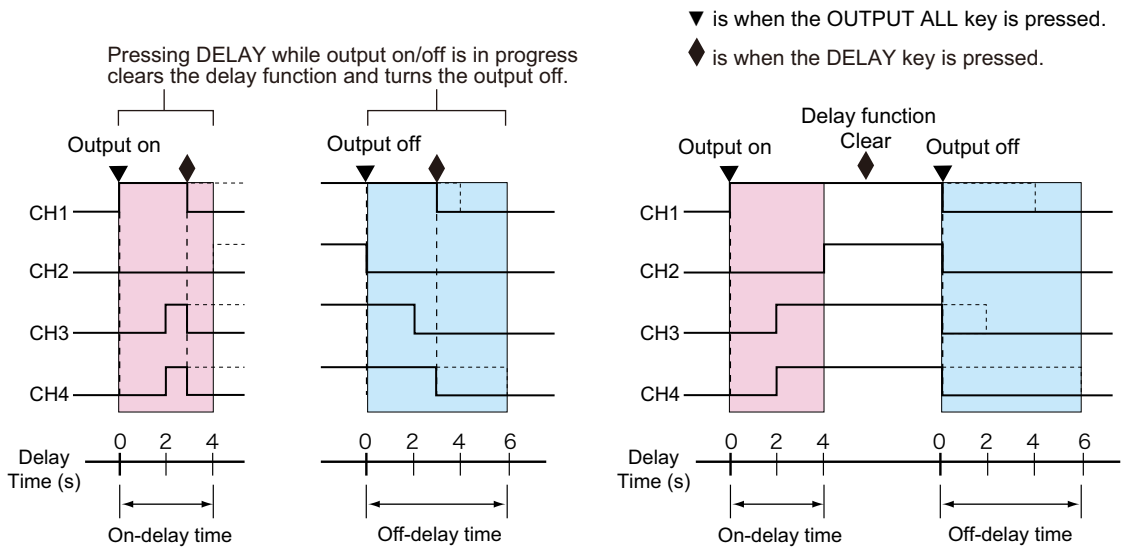

Example of PMX32-2QU

The actual rise time at output-on and the fall time at output-off very depending on the output and load conditions. The timing charts above ignore the rise and fall times.

Because there is time for internal processing from when OUTPUT ALL is pressed until the output actually turns on or off, even if you set the delay time 0 s, there will be an error in the order of tens of milliseconds.

Setting the output-on delay/ off delay time

If the external control for turning the output on or off in the CONFIG settings is set to on (CF04: ON), the delay function cannot be used. Set the external control for turning output on and off to off (CF04: OFF).

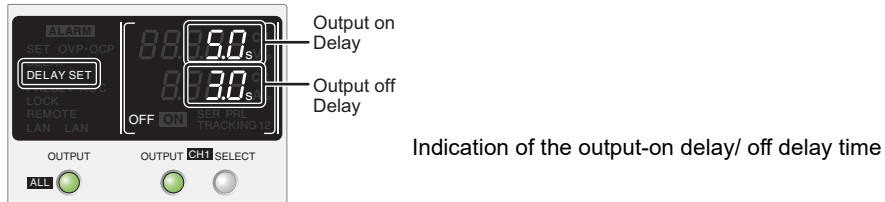

- 1 Press OUTPUT ALL to turn off the output.**
The output of all channels is turned off.
- 2 Press DELAY SET (SHIFT+DELAY).**
“DELAY SET” appears in the display area.
- 3 Press SELECT to select the channel you want to configure.**
The selected channel is indicated with brackets.
- 4 Set the output-on delay time using the VOLTAGE knob and the output-off delay time using the CURRENT knob.**

Delay time setting range 0.1 s to 99.9 s

Resolution 1 s, fine mode: 0.1 s

The voltmeter shows the output-on delay time and the ammeter the output-off delay time.

- 5 To set other channels, repeat steps step 3 and step 4.**
- 6 To exit from the delay time setting, press DELAY SET (SHIFT+DELAY), LOCK, or SET.**

The “DELAY SET” indicator disappears. If you pressed DELAY SET (SHIFT+DELAY) or LOCK, the measurement display appears. If you pressed SET, the setting display appears.

This completes the setting.

Activating the output-on delay/ off delay

Only the OUTPUT ALL key can be used to control the output-on delay/ off delay. output-on delay/ off delay will not be activated using the OUTPUT key of each channel.

The output of channels that do not have a delay time set will also be turned on or off simultaneously.

- 1 Press DELAY.**
“DELAY” appears in the display area.
- 2 To activate the output-on delay, press OUTPUT ALL to turn the output on.**
When the output-on delay is activated, “DELAY” blinks in the display area. When all channels turn on, “DELAY” changes from blinking to solid.
- 3 To activate the output-off delay, press OUTPUT ALL again to turn the output off.**
When the output-off delay is activated, “DELAY” blinks in the display area. When all channels turn off, “DELAY” changes from blinking to solid.
- 4 To clear the delay function, press DELAY.**
The “DELAY” indicator will disappear from the display area.

CV Power Supply and CC Power Supply

The PMX has functions that makes it possible to function as a constant-voltage source and constant-current source even when the load is changed. The constant-voltage source operation is referred to as constant-voltage (CV) mode. The constant-current source operation is referred to as constant-current (CC) mode. The operation mode is determined by the following three values.

- Output voltage setting (V_s)
- Output current setting (I_s)
- Load resistance (R_L)

The operation modes are described below.

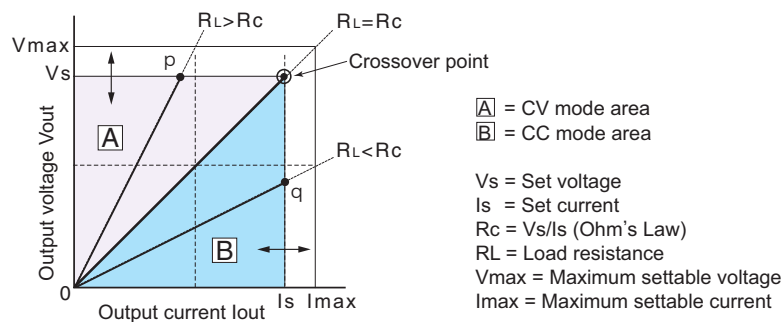

The above figure shows the product's operation modes. The load resistance is denoted as R_L . The resistance, which is denoted as R_c , is calculated from the set voltage and current ($R_c = V_s/I_s$). The power supply is designed so that it operates in CV mode in area A and CC mode in area B . The boundary is the line defined by $R_L = R_c$. This line represents the load at which the output voltage and the set voltage are equal and the output current and the set current are equal. If load resistance R_L is greater than resistance R_c , the operating point is in area A , and the PMX operates in CV mode (point p). In this case, the set current I_s equals the current limit.

When the product is operating in CV mode, the output voltage is maintained at the set voltage. Output current I is determined by the equation $I = V_s/R_L$ and is a current that is less than current limit I_s . The actual current that flows is not necessarily equal to the specified value.

For loads in which transient overcurrent flows, current limit I_s must be set higher than the overcurrent value.

Conversely, if load resistance R_L is less than resistance R_c , the operating point is in area B , and the product operates in CC mode (point q). In this case, set voltage V_s equals the voltage limit.

When the product is operating in CC mode, the output current is maintained at the set current. Output voltage V is determined by the equation $V = I_s \times R_L$ and is a voltage that is less than voltage limit V_s . The actual voltage that is applied is not necessarily equal to the specified value.

For loads that generate transient overvoltage, voltage limit V_s must be set higher than the over.

■ Crossover point

The product switches automatically between CV mode and CC mode according to the changes in the load. A crossover point is the point at which the mode switches.

For example, when operating in CV mode, if the load changes and the output current reaches the current limit, the PMX automatically switches to CC mode to protect the load. Likewise, when operating in CC mode, if the output voltage reaches the voltage limit, the PMX switches to CV mode.

CV mode and CC mode operation example

This section uses a power supply with a rated output voltage of 100 V and a rated output current of 10 A as an example.

A load resistance (R_L) of 8 Ω is connected to the output terminals of the power supply. The output voltage and output current are set to 30 V and 5 A, respectively. In this case, $R_c = 30 \text{ V}/5 \text{ A} = 6 \Omega$. Because 8 Ω is greater than 6 Ω ($R_L > R_c$), the power supply operates in CV mode. When you want to increase the voltage in CV mode, you can increase the voltage up to the voltage defined by the following equation: $V_s = I_s \times R_L$. Substituting the values, we obtain $V_s = 5 \text{ A} \times 8 \Omega = 40 \text{ V}$. If you try to increase the voltage above this point, the crossover point is reached, and the power supply automatically switches to CC mode. To maintain operations in CV mode, increase the current limit.

Next, a load resistance (R_L) of 5 Ω is connected to the output terminals of the power supply. The output voltage and output current are set to 30 V and 5 A, respectively. In this case, $R_c = 30 \text{ V}/5 \text{ A} = 6 \Omega$. Because 5 Ω is less than 6 Ω ($R_L < R_c$), the power supply operates in CC mode. If you want to increase the current in CC mode, you can increase the current up to the current defined by the following equation: $I_s = V_s/R_L$. Substituting the values, we obtain $I_s = 30 \text{ V}/5\Omega = 6 \text{ A}$. If you try to increase the current above this point, the crossover point is reached, and the power supply automatically switches to CV mode. To maintain operations in CC mode, increase the voltage limit.

Using the PMX as a CV or CC Power Supply

When the PMX is used as a constant-voltage power supply, the set current is the limit to the current that can flow through the load.

When the PMX is used as a constant-current power supply, the set voltage is the limit to the voltage that can be applied to the load.

If the specified limit is reached, the PMX automatically switches its operation mode. When the PMX switches its operation mode, the “CV” (green) and “CC” (red) indications in the display area change.

1 Press SET to change to the setting display.

“SET” appears in the display area.

2 Press SELECT to select the channel you want to configure.

The selected channel is indicated with bracketsed.

3 Turn the VOLTAGE knob to set the voltage.

Voltage setting range: 0 % to 105 % of the rated output voltage of each channel

	CH1	CH2	CH3	CH4
PMX32-3DU	0 V to 33.6 V	0 V to 33.6 V	–	–
PMX32-3TR	0 V to 33.6 V	0 V to 33.6 V	0 V to 6.3 V	–
PMX32-2QU	0 V to 33.6 V	0 V to 33.6 V	0 V to 18.9 V	0 V to 18.9 V

4 Turn the CURRENT knob to set the current.

Current setting range: 0 % to 105 % of the rated output voltage of each channel

	CH1	CH2	CH3	CH4
PMX32-3DU	0 A to 3.15 A	0 A to 3.15 A	–	–
PMX32-3TR	0 A to 3.15 A	0 A to 3.15 A	0 A to 5.25 A	–
PMX32-2QU	0 A to 2.1 A	0 A to 2.1 A	0 A to 2.625 A	0 A to 2.625 A

5 To set other channels, repeat steps step 2 to step 4.

6 Press OUTPUT to turn output on.

“SET” disappears from the display area, and “ON” appears. When the PMX is operating as a constant-voltage power supply, “CV” (green) is displayed. When the PMX is operating as a constant-current power supply, “CC” (red) is displayed.

This completes the setting.

Even when the output is on, you can set the voltage and current by carrying out step 3 and step 4 while checking the actual output voltage or current ([p.26](#)).

You can use the CONFIG settings to set the output-on startup state (CF06: [] / []) ([p.46](#)).

Set this according to the operation mode that you are using. You can prevent overshoot from occurring when the output is turned on by prioritizing CV when using the PMX as a constant-voltage power supply and by prioritizing CC when using the PMX as a constant-current power supply.

When the output is turned on, the internal capacitors are charged. Depending on the set current, the PMX may enter CC mode for an instant.

Protection Functions and Alarms

This product is equipped with the following protection functions.

- Overvoltage protection (OVP) (p.38)
- Overheat protection (OHP) (p.41)
- Alarm input (ALARM IN) (p.41)
- Overcurrent protection (OCP) (p.39)
- Communication monitoring (WATCHDOG) (p.41)

Alarm occurrence and clearing alarms

Alarm occurrence

When the output is shut off by a protection function, an alarm occurs, and the PMX is set to the following state.

- The output is turned off.

You can use the CONFIG settings to set the output state (CF08) for when OVP/OCP is activated (p.47).

- The display area shows “ALARM” (red), the voltmeter shows “RL”, and the ammeter shows the cause of the alarm.

When a CONFIG parameter is displayed, the cause of alarm is not displayed.

- An alarm signal is output.

When an alarm occurs, an alarm signal is output from pin 12 of the CONTROL TERMINAL.

Clearing alarms

Press ALM CLR (SHIFT + SET) or turn off the POWER switch. Fix the problem that caused the alarm, and turn the POWER switch back on. When clearing an alarm with an alarm input (ALARM IN), turn the POWER switch off once and then back on.

If you do not resolve the cause of the alarm, an alarm will occur again.

If an alarm still occurs even after you have resolved all the causes of alarms, the product may be malfunctioning. Stop using it immediately, and contact your Kikusui agent or distributor.

Alarm signal

The output terminal is isolated from other terminals through an open collector photocoupler. The output-on signals of CH1 to CH4 and the power-on signal share a common ground.

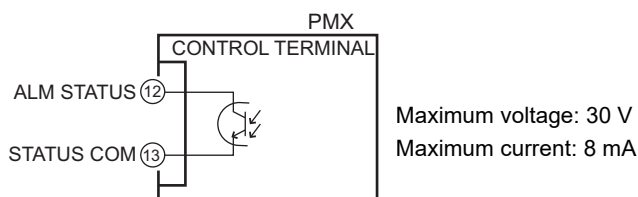

Setting and displaying the protection functions

Overvoltage protection (OVP)

Overvoltage protection (OVP) is activated when the output terminal voltage exceeds the set voltage (OVP trip point).

Immediately after you purchase the PMX or immediately after a load is changed, set the OVP trip point to a value that is appropriate for the load.

■ Setting the OVP trip point

OVP operates on the output terminal voltage. If you want to activate the protection feature according to the voltage across the load, take the voltage drop in the load cable into consideration when you set the OVP trip point.

1 Press OVP•OCP.

The display area shows “OVP•OCP”, and the voltmeter displays the present OVP trip point.

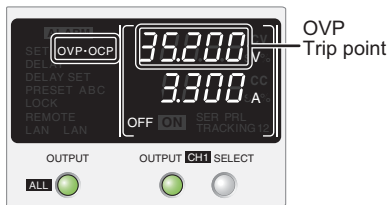

OVP trip point indication

2 Press SELECT to select the channel you want to configure.

The selected channel is indicated with brackets.

3 Turn the VOLTAGE knob to set the OVP trip point.

OVP setting range: 10 % to 110 % of the rated output voltage

	CH1	CH2	CH3	CH4
PMX32-3DU	3.2 V to 35.2 V	3.2 V to 35.2 V	–	–
PMX32-3TR	3.2 V to 35.2 V	3.2 V to 35.2 V	0.6 V to 6.6 V	–
PMX32-2QU	3.2 V to 35.2 V	3.2 V to 35.2 V	1.8 V to 19.8 V	1.8 V to 19.8 V

4 To set other channels, repeat steps step 2 and step 3.

5 Press OVP•OCP, LOCK, or SET to finish the configuration.

The OVP trip point will be set. The “OVP•OCP” indicator will disappear from the display area. If you pressed OVP•OCP or LOCK, the measurement display appears. If you pressed SET, the setting display appears.

This completes the setting.

■ Checking the OVP operation

- 1** Check that “ON” (green) is not shown in the display area.
- 2** Set the output voltage to a value lower than the OVP trip point.
- 3** Press **OUTPUT** to turn output on.
“ON” (green) appears in the display area.
- 4** Slowly turn the **VOLTAGE** knob clockwise until the OVP is activated.
When the output voltage exceeds the OVP trip point, an alarm will occur. “ALARM” (red) is displayed to indicate that OVP has been activated.

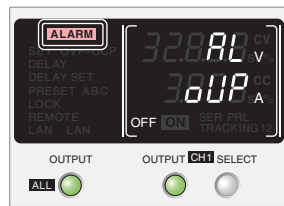

Alarm indication when OVP is activated

- 5** Check that output has turned off.
- 6** Press **ALM CLR (SHIFT + SET)** to clear the alarm.
If you do not change the output voltage and turn the output on, OVP will be activated again.

Overcurrent protection (OCP)

Overcurrent protection (OCP) is activated when the output current exceeds the set current (OCP trip point).

Immediately after you purchase the product or immediately after a load is changed, set the OCP trip point to a value that is appropriate for the load.

■ Setting the OCP trip point

- 1** Press **OVP•OCP**.
The display area shows “OVP•OCP”, and the ammeter displays the present OCP trip point.

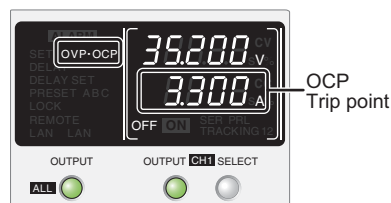

OCP trip point indication

- 2** Press **SELECT** to select the channel you want to configure.
The selected channel is indicated with brackets.

3 Turn the CURRENT knob to set the OCP trip point.

OCP setting range: 10 % to 110 % of the rated output current

	CH1	CH2	CH3	CH4
PMX32-3DU	0.3 A to 3.3 A	0.3 A to 3.3 A	–	–
PMX32-3TR	0.3 A to 3.3 A	0.3 A to 3.3 A	0.5 V to 5.5 V	–
PMX32-2QU	0.2 A to 2.2 A	0.2 A to 2.2 A	0.25 A to 2.75 A	0.25 A to 2.75 A

4 To set other channels, repeat steps step 2 to step 4.

5 Press OVP•OCP, LOCK, or SET to finish the configuration.

The OCP trip point will be set. The “OVP•OCP” indicator will disappear from the display area. If you pressed OVP•OCP or LOCK, the measurement display appears. If you pressed SET, the setting display appears.

This completes the setting.

■ Checking the OCP operation

To check the OCP operation, short the output terminals of the channel you want to check.

1 Check that “ON” (green) is not shown in the display area.

2 Set the output current to a value lower than the OCP trip point.

3 Press OUTPUT to turn output on.

“ON” (green) appears in the display area.

4 Slowly turn the CURRENT knob clockwise until the OCP is activated.

When the output current exceeds the OCP trip point, an alarm will occur. “ALARM” (red) appears in the display area to indicate that OCP has been activated.

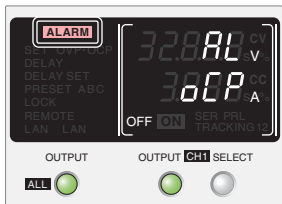

Alarm indication when OCP is activated

5 Check that output has turned off.

6 Press ALM CLR (SHIFT + SET) to clear the alarm.

If you do not change the output current and turn the output on, OCP will be activated again.

Overheat protection (OHP)

Overheat protection (OHP) is activated when the product's internal temperature rises to an abnormal level.

- When the product is used in an environment that exceeds its operating ambient temperature range (0 °C to +40 °C).
- When the product is used with its air inlet or outlet port blocked.
- When the fan motor has stopped.

If you do not fix the problem that caused the overheat protection to be activated, OHP will be activated again even if you turn the POWER switch off and on.

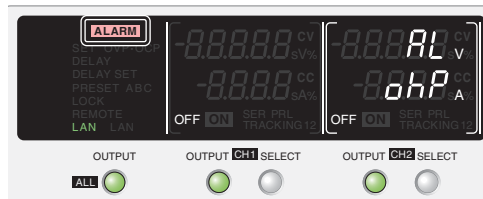

Alarm indication when OHP is activated

Communication monitoring (WATCHDOG)

The watchdog function monitors the SCPI command communication status.

Communication is assumed to have stopped if there is no communication within the time period specified by the communication monitoring timer setting (CF24).

The function operates regardless of whether the product is in remote or local (panel control) mode. If you are not using remote control (commands), set communication monitoring off using a timer setting.

In the alarm state, turn off communication monitoring before clearing the alarm.

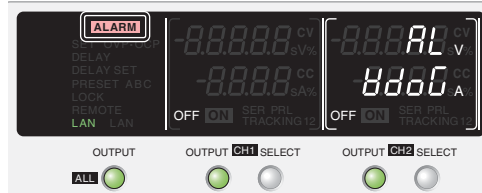

Alarm indication when WATCHDOG is activated

Alarm input (ALARM IN)

The output of all channels is turned off when the PMX receives an alarm signal (0.5 V or less, or shorted with pin 13) through pin 12 of the J1 connector when an abnormal condition occurs.

To apply an alarm signal, short the contact switch for at least 0.5 s. If the time is too short, the alarm may not be detected.

Even when the POWER switch is turned off and then turned back on, if an alarm signal is being received, ALARM IN will be activated again.

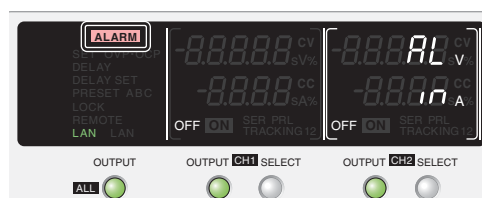

Alarm indication when ALARM IN is activated

CONFIG Settings

Use the CONFIG settings to perform system configuration of the product. You can set and display the following parameters in the CONFIG settings.

Effect: ● indicates that the parameter is affected when the panel settings are reset (CF00).

■ indicates that the parameter may be affected when the LAN interface settings are reset (CF40: LC / dEF/RPPL).

Note: "A" indicates that the parameter is applied when the PMX exits from CONFIG settings.

"B" indicates that the parameter is applied when the power is turned on. "C" indicates that the parameter is applied after CF40 is executed.

Display switching	Parameter number	Mnemonic	Setting/ display	Effect	Note	
System	CF00	–	Reset	Panel setting reset	–	A
	CF01	PON	Power on	Output state at power-on	–	B
	CF02	MEM	Memory	Memory content display	–	A
	CF03	LOC	Lock	Key lock content	–	A
	CF04*1	E.OUT	Ext. on/ off	External control for turning output on/off	●	A
	CF05*1	E.LOG	Ext. logic	External control logic for turning output on/off	–	A
	CF06*1	PRI0	Priority	Output-on startup state	–	A
	CF07*1	RIS.T	Rise Time	Rise time when a value is changed	–	A
	CF08	A.OFF	Alarm off	Output state when a protection function (OVP/OCP) is activated	–	A
	CF09*1	DTRC	Dual tracking	Tracking operation	–	A
Interface	CF20	LAN	LAN	LAN interface	■*2	B
	CF21	USB	USB	USB interface	–	B
	CF22	232	RS232C	RS232C interface	–	B
	CF23	TRAC	Trace	SCPI communication error display	–	A
	CF24	WDOG	Watchdog	Communication monitoring (watchdog) timer	–	A
	CF25	BEEP	Beep	Buzzer on/off	–	A
LAN*3	CF30	IP1	Ip addr. 1	IP address display (1)	–	–
	CF31	IP2	Ip addr. 2	IP address display (2)	–	–
	CF32	IP3	Ip addr. 3	IP address display (3)	–	–
	CF33	IP4	Ip addr. 4	IP address display (4)	–	–
	CF34	HA1	HW. addr. 1, 2	MAC address display (1) and (2)	–	–
	CF35	HA2	HW. addr. 3, 4	MAC address display (3) and (4)	–	–
	CF36	HA3	HW. addr. 5, 6	MAC address display (5) and (6)	–	–
	CF40	BOOT	LAN Reboot	LAN setting reset (LC/DEF)/apply (APPL)	–	A
	CF41	ADR	Address config	IP address assignment method	■	B/C
	CF42	S.IP1	Static IP 1	Manual IP address setting (1)	■	B/C
	CF43	S.IP2	Static IP 2	Manual IP address setting (2)	■	B/C
	CF44	S.IP3	Static IP 3	Manual IP address setting (3)	■	B/C
	CF45	S.IP4	Static IP 4	Manual IP address setting (4)	■	B/C
	CF46	SUB	Subnet Mask	IP address subnet mask	■	B/C
USB	CF50*4	VID	V. ID	Vendor ID (VID) display	–	–
		PID	P. ID	Product ID (PID) display	–	–
RS232C	CF51	BAUD	Baud rate	RS232C baud rate	–	B
Firmware	CF60*5	VER	Version	Firmware version display	–	–
		B.NO	Bild no.	Build number display	–	–

*1. Can be set separately for each channel

*2. This parameter is affected only when the LAN interface settings are reset (CF40: LC / dEF/ RPPL).

*3. For details on the LAN interface settings, see the "Communication Interface Manual" on the included CD-ROM.

*4. The vendor ID is shown in CH1 and the product ID in CH2.

*5. The firmware version is shown in CH1 and the build number in CH2.

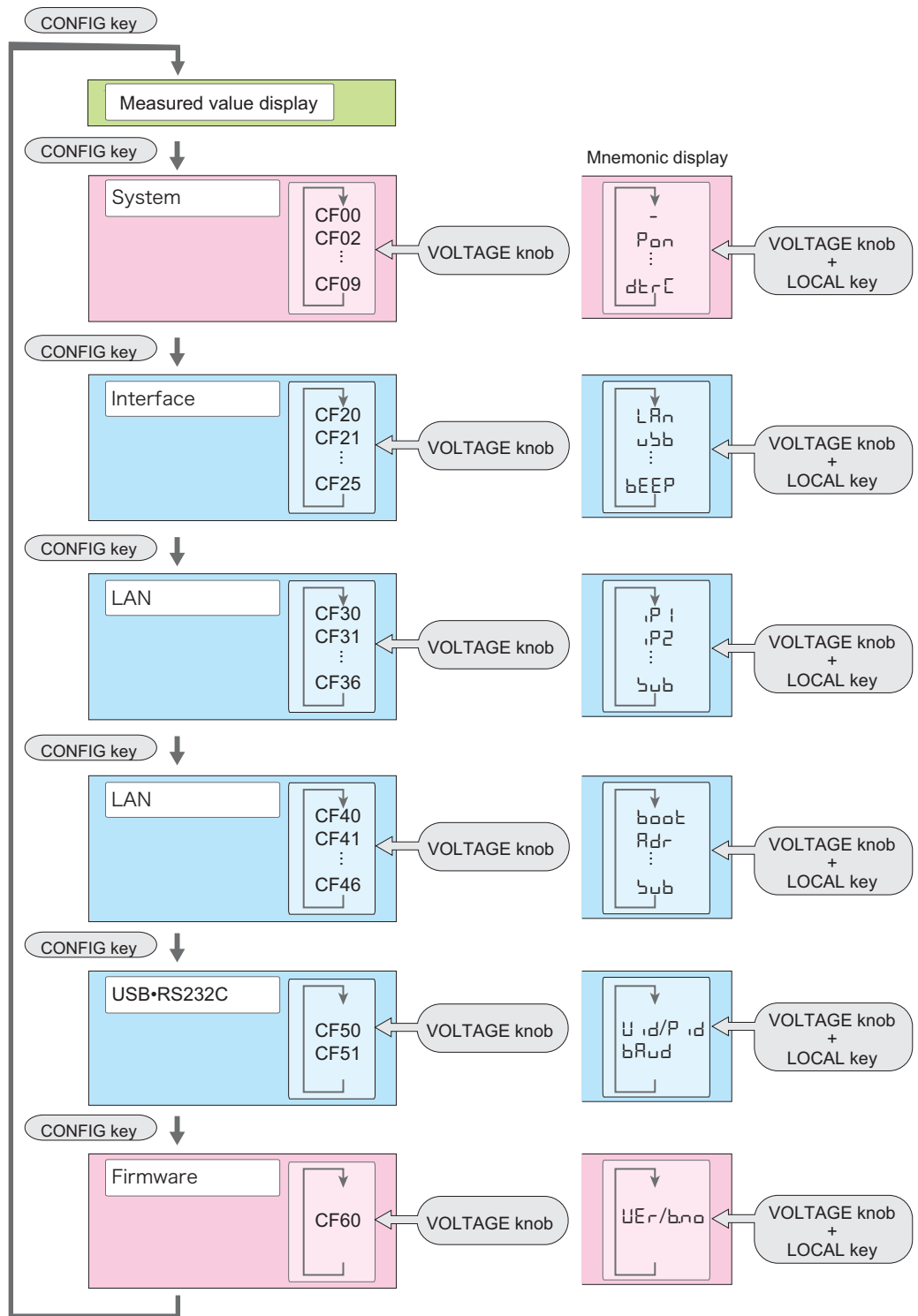

Displaying and setting CONFIG parameters

CF00 and CF40 are execution parameters of functions. For the execution procedure, see the details of each CONFIG parameter.

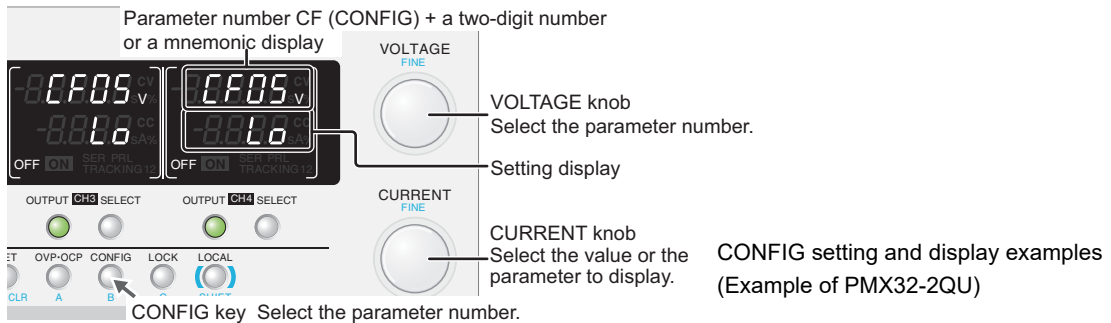

1 Use the CONFIG key and the VOLTAGE knob to select the CONFIG parameter you want to set.

The voltmeter displays the parameter number. The ammeter displays the corresponding setting. Parameters that can be set separately for each channel are displayed on all channels. Parameters that are set to the same value on all channels are displayed only in the CH2 display area.

Each time you press CONFIG, the parameter number changes in the following order: CF00→CF20→CF30→CF40→CF50→CF60→measurement display. Turning the VOLTAGE knob changes the ones digit.

Pressing LOCAL changes the parameter number to the mnemonic display. Turning the VOLTAGE knob while holding down the LOCAL key switches the CONFIG parameter while retaining the mnemonic display.

2 Turn the CURRENT knob to change the value of the parameter.

3 To specify or display other parameters, repeat step 1 and step 2.

4 Hold down CONFIG until the measurement display appears or press SET to exit from CONFIG settings.

There are parameters whose values are applied immediately, those whose values are applied after the power is turned off and then back on, and those whose values are applied when [RPPPL] is executed using CF40 (p.42).

This completes the setting.

CONFIG parameter details

The details of CONFIG parameters are provided below.

CF00 (r3t) Panel setting reset

Select this to set the following parameters to their factory default settings (p.96). Then, press SET twice to execute the reset.

- Output voltage
- Overvoltage protection
- output-on delay/ off delay time
- Output state when the power is turned on (CF01)
- Output current
- Overcurrent protection
- Parallel operation and series operation
- External control for turning output on/off (CF04)

Display	Description
r3t Reset	Resets the panel settings

CF01 (Pon) Output state when the power is turned on

Sets the output state that the PMX will be in when the power is turned on (p.29). When you are using an external contact to turn the output off, this parameter is invalid. To apply the setting, turn off the power and then turn it back on.

Even when set to “Ruto,” if a load with accumulated energy, such as a battery, is connected, the output may not turn on when the power is turned on even after the power is turned off with the output turned on.

Display	Description
3RFE Safe	The output is off (factory default setting)
Ruto Auto	The output state that the PMX was in immediately before the power was turned off
Fon Force	Output on

CF02 (nen) Memory content display

Sets whether the PMX will show the saved contents in the memory before they are recalled.

Display	Description
oFF oFF	Recall without showing the saved contents in the memory
on on	Recall after showing the saved contents in the memory (factory default setting)

CF03 (L o C) Key lock content

The key lock function locks the panel. Select from the following three values.

Display	Description	
L o C 1	Lock1	Only the OUTPUT key and recalling of memory (A/B/C) are allowed.
L o C 2	Lock2	Only the OUTPUT key can be used.
L o C 3	Lock3	All keys and rotary operations are disabled (factory default setting).

CF04 (E o u t) External control for turning output on and off

Enables or disables output on/off control using an external contact (p.63).
Can be set separately for each channel.

Display	Description	
o F F	OFF	Disabled (factory default setting)
o n	ON	Enabled

CF05 (E L o G) External control logic for turning output on and off

Sets the logic that is used for output on/off control using an external contact (p.63).
Can be set separately for each channel.

Display	Description	
L o	LOW	The output is turned on with a LOW signal (0 V to 0.5 V) or short circuit (factory default setting).
h i	HIGH	The output is turned on with a HIGH signal (4.5 V to 5 V) or open circuit.

CF06 (P r i o) Output-on startup state

Sets the prioritized operation mode when the output is turned on (p.36). Can be set separately for each channel.

Display	Description	
C V	CV	CV (constant voltage) is prioritized (factory default setting).
C C	CC	CC (constant current) is prioritized.

CF07 (r i s e) Rise time when a value is changed

You can set the rise time that is applied when you change a value (p.29). Can be set separately for each channel.

If you specify "F R i s e," the rising waveform may become unstable and distort.

Display	Description	
S L O W	SLOW	The value rises in 100 ms (factory default setting).
F R i s e	FAST	The value rises in 10 ms.

CF08 (R_{OFF}) Output state when a protection function (OVP/OCP) is activated

Sets the output state when a protection function (OVP/OCP) is activated (p.37).

When the output-on delay/ off delay time is set, the output of all channels turns off regardless of the setting.

Display		Description
SELF	SELF	The output is turned off only on the channels on which an alarm occurs.
ALL	ALL	The output of all channels is turned off (factory default setting).

CF09 (d_{tr}) Tracking operation

Enables or disables the tracking operation (p.54). Can be set separately for each channel.

Set this so that at least two channels have the tracking operation turned on. You cannot specify less than two channels.

Display		Description
OFF	OFF	Tracking operation is disabled.
ON	ON	Tracking operation is enabled.

Factory default settings	Model	CH1	CH2	CH3	CH4
	PMX32-3DU	ON	ON	-	-
	PMX32-3TR	ON	ON	OFF	-
	PMX32-2QU	ON	ON	OFF	OFF

CF20 (L_{Rn}) LAN interface

Enables or disables the LAN interface.

Setting this parameter to "OFF" disables the LAN interface function even when a LAN cable is connected.

To apply the setting, turn off the power and then turn it back on.

Display		Description
OFF	OFF	LAN disabled
ON	ON	LAN enabled (factory default setting).

CF21 (u_b) USB interface

Enables or disables the USB interface.

Setting this parameter to "OFF" disables the USB interface function even when a USB cable is connected.

To apply the setting, turn off the power and then turn it back on.

Display		Description
OFF	OFF	USB disabled
ON	ON	USB enabled (factory default setting).

CF22 (232) RS232C interface

Enables or disables the RS232C interface.

Setting this parameter to “OFF” disables the RS232C interface function even when an RS232C cable is connected.

To apply the setting, turn off the power and then turn it back on.

Display		Description
OFF	OFF	RS232C disabled
ON	ON	RS232C enabled (factory default setting).

CF23 (ERR) SCPI communication error display

Sets whether to display communication errors.

When set to “ON,” the error is displayed in CH2.

Display		Description
OFF	OFF	SCPI communication errors are not displayed (factory default setting).
ON	ON	SCPI communication errors are displayed.

CF24 (WDOG) Communication monitoring (WATCHDOG) timer

Sets the interval for monitoring SCPI command communication (p.41).

The communication monitoring function operates regardless of whether the product is in remote or local (panel control) mode.

If you are not using remote control (commands), set this to “OFF”.

Display		Description
OFF	OFF	Communication monitor timer is set to off (factory default setting).
1 to 3000	1 to 3000	1 s, 3 s, 10 s, 30 s, 100 s, 300 s, 1000 s, 3000 s

CF25 (BEEP) Buzzer on or off

Turns the buzzer on and off.

The buzzer sounds when settings are reset to factory defaults, when a communication command error occurs, or when memory cannot be recalled.

Display		Description
OFF	OFF	Buzzer off
ON	ON	Buzzer on (factory default setting).

CF30 to CF33 (IP 1 to IP4) IP address display

These parameters display the set IP addresses.

To set a fixed IP address, set it from the panel (CF42 to CF45) or from the Web browser interface. When you access the PMX through a Web browser, do so under conditions in which a DHCP server or AUTO IP can be used.

For details on the Web browser interface, see the Communication Interface Manual on the included CD-ROM.

Parameter number	Display		Description
CF30	□ to 255	0 to 255	First octet of the IP address
CF31	□ to 255	0 to 255	Second octet of the IP address
CF32	□ to 255	0 to 255	Third octet of the IP address
CF33	□ to 255	0 to 255	Fourth octet of the IP address

CF34 to CF36 (H1 to H3) MAC address display

These parameters display the set MAC addresses.

MAC addresses are set to 00.0F.CE.xx.xx (where x is a hexadecimal number between 0 and F).

Parameter number	Display		Description
CF34	□□□□	00.0F	First and second octets of the MAC address
CF35	□□HH	CE.xx	Third and fourth octets of the MAC address
CF36	HHHH	xx.xx	Fifth and sixth octets of the MAC address



CF34: 00.0F



CF35: CE.11



CF36: 22.33

Display example of the MAC address "00.0F.CE.11.22.33"

CF40 (boot) LANsetting reset (LCI/ dEF) or apply (APPL)

Sets whether to reset or apply the LAN interface settings. Then, press SET twice to execute the reset or application.

If you select to reset the LAN interface settings (LCI, (LCI)/dEF (Default)), the security password will be cleared, and the PMX will be in a security-disabled state.

If the LAN LED turns red (p.9), set the settings again.

For details on the LAN interface settings, see the "Communication Interface Manual" on the included CD-ROM.

Display		Description
LCI	LAN Configuration Initialize	Resets the LAN interface settings (to their factory default values)
dEF	Default	Resets the LAN interface and host name settings (to their factory default values)
APPL	Apply	The LAN interface is restarted, and the CONFIG settings are applied.

CF41 (Rdr) IP address assignment method

Sets the IP address assignment method.

Set whether to use (on: 1) or not use (off: 0) the following: DHCP server, AUTO IP function (automatic assignment), and MANUAL IP function (manual assignment).

If DHCP and AUTO IP are both set to on and an IP address is not assigned through a DHCP server, AUTO IP is used.

To use MANUAL IP, set DHCP and AUTO IP to off. The IP address that is assigned by the AUTO IP function is 169.254.x.x (where x is a number between 1 and 254).

To apply the setting, turn off the power and then turn it back on or execute “RPPL (Apply)” using CF40.

Display	Description
001	DHCP: off, AUTO IP: off, MANUAL IP: on
010	DHCP: off, AUTO IP: on, MANUAL IP: off
011	DHCP: off, AUTO IP: on, MANUAL IP: on
100	DHCP: on, AUTO IP: off, MANUAL IP: off
101	DHCP: on, AUTO IP: off, MANUAL IP: on
110	DHCP: on, AUTO IP: on, MANUAL IP: on (factory default setting)
111	DHCP: on, AUTO IP: on, MANUAL IP: on

CF42 to CF45 (L, P 1 to L, P 3) Manual IP address setting (MANUAL IP)

If you are not using the DHCP server or the AUTO IP function, set the IP address manually. To do so, use CF41 to set MANUAL IP to on.

To apply the setting, turn off the power and then turn it back on or execute “RPPL (Apply)” using CF40.

Parameter number	Display	Description
CF42	0 to 255	First octet of the IP address
CF43	0 to 255	Second octet of the IP address
CF44	0 to 255	Third octet of the IP address
CF45	0 to 255	Fourth octet of the IP address

CF46 (Lb) IP address subnet mask

If you want to set the IP address manually (MANUAL IP), set the subnet mask prefix. To do so, use CF41 to set MANUAL IP to on.

To apply the setting, turn off the power and then turn it back on or execute “RPPL (Apply)” using CF40.

Display	Description
16 to 31	Sets the subnet mask prefix (the factory default setting is 24)

Example: Display example when “16” is selected 255.255.0.0
 Display example when “24” is selected 255.255.255.0
 Display example when “31” is selected 255.255.255.254

CF50 (VID) Vendor ID (VID) and (PID) product ID (PID) display

Displays the USB vendor ID and product ID.
The vendor ID is shown in the CH1 display area and the product ID in the CH2 display area.

Display	Vendor ID.		
0b3E	0b3E	0x0B3E	

Model	Display	Product ID:	
PMX32-3DU	102A	102A	0x102A
PMX32-3TR	102B	102B	0x102B
PMX32-2QU	102C	102C	0x102C

CF51 (BRUD) RS232C baud rate

Sets the baud rate of the RS232C interface.
This parameter is applied when you turn the POWER switch off and on.

Display	Baud rate	
1.2	1.2	1200 bps
2.4	2.4	2400 bps
4.8	4.8	4800 bps
9.6	9.6	9600 bps
19.2	19.2	19200 bps (factory default setting)
38.4	38.4	38400 bps
57.6	57.6	57600 bps
115.2	115.2	115200 bps

CF60 (VER) Firmware version and (BLD) build number display

Displays the firmware version and build number.
The firmware version is shown in the CH1 display area and the build number in the CH2 display area.

Display	The firmware version	
VHHH	Vx.xx	Ver. x.xx (where x is between 0 and 9)

Display	Build number	
HHHH	xxxx	BLDxxxx (where x is between 0 and 9)

Memory Function

There are memory areas for saving combinations of voltage, current, OVP, OCP, and output-on delay/ off delay settings. Saved settings can be recalled from the memory when needed.

There are three memory areas (A,B, and C) for normal operation, parallel operation, and series operation.

For normal operation, the settings of all channels can be stored and recalled.

For parallel operation and series operation, the master (CH2) settings can be stored and recalled.

For the other channels of PMX32-3TR/ PMX32-2QU, the applied settings can be stored and recalled, which are shared between normal operation, parallel operation, and series operation.

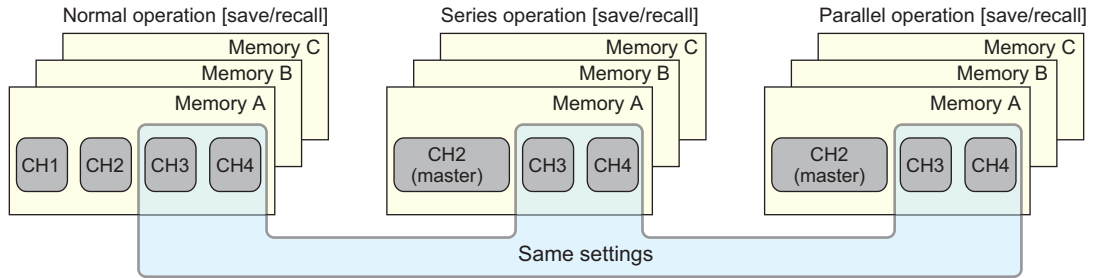

Example of PMX32-2QU

Saving settings

- 1 Press SELECT to select the channel you want to configure.**
The selected channel is indicated with brackets.
- 2 Press SET.**
"SET" appears, and the present voltage and current are displayed on the panel.
- 3 While viewing the panel display, turn the VOLTAGE and CURRENT knobs to set the voltage, current, OVP, OCP, and output-on delay/ off delay.**
- 4 To set other channels, repeat step 1 and step 3.**
- 5 Hold down memory key A (SHIFT+OVP•OCP), B (SHIFT+CONFIG), or C (SHIFT+LOCK) until the destination where the settings will be saved to (PRESET A, B, or C) appears.**
The status display area shows the selected memory area (A, B, or C), and the settings are saved. When you press SET, the "SET" indicator appears in the display area, and the saved settings are displayed.
This completes the setting.

By following step 5, you can save to the memory when the output is on and the measurement display is shown ("SET" not shown). After saving to memory, press SET to check the memory settings.

If settings are recalled from the memory during normal operation, the settings saved to all channels will be recalled.

Recalling settings

You can recall settings from the memory on the measurement display ("SET" not shown) or the setting display ("SET" shown).

The contents in the memory are recalled to all channels.

If the output is on, the settings are applied to the output the moment they are recalled.

There are two ways to recall settings from memory. One way is to display the saved contents and recall them after confirming them (CF02: 00), and the other is to recall them immediately (CF02: 0FF).

NOTE

If you hold down memory key A (SHIFT+OVP•OCP), B (SHIFT+CONFIG), or C (SHIFT+LOCK), the present settings will be saved to the memory.

Displaying the saved contents and recalling them after confirmation

- 1** Use the CONFIG settings to set the PMX to display the saved contents of the memory (CF02: 00).
- 2** Press the key of the memory you want to recall from: A (SHIFT+OVP•OCP), B (SHIFT+CONFIG), or C (SHIFT+LOCK).
The selected memory area (A, B, or C) blinks.
- 3** Check the displayed settings, and then press SET.
The selected memory area (A, B, or C) changes from blinking to solid. The recalled memory contents (voltage and current) are displayed and applied to the output.
Press LOCAL to cancel recalling.

Recalling the saved contents without displaying them

- 1** Use the CONFIG settings to set the PMX to hide the saved contents of the memory (CF02: 0FF).
- 2** Press the key of the memory you want to recall from: A (SHIFT+OVP•OCP), B (SHIFT+CONFIG), or C (SHIFT+LOCK).
The display area shows the selected memory area (A, B, or C), and the settings are recalled.

Locking the Panel Controls (Key Lock)

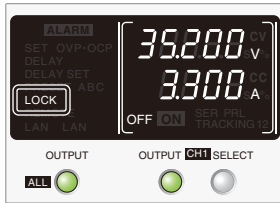

The key lock function can be used to prevent the settings from being changed by mistake.

When the keys are locked, “LOCK” is shown in the display area.

There are three key lock types. Use CONFIG parameter CF03 to set the type.

- Key lock 1 (Loc1): Lock all keys except the OUTPUT and memory A, B, and C keys.
- Key lock 2 (Loc2): Locks all keys except the OUTPUT key.
- Key lock 3 (Loc3): Lock all keys and the rotary knob.

1 Configure all the parameters, such as the output voltage and output current, as necessary.

2 Hold down LOCK until “LOCK” appears in the display area.

Key lock is enabled.

To release the key lock, hold down LOCK until “LOCK” disappears.

Tracking Function

The tracking function varies the outputs simultaneously.

The outputs of other channels change simultaneously along with the reference channel.

The outputs can be varied according to the amount of change (TRACKING 1: absolute value change) or varied at the same percentage (TRACKING 2: percentage change).

If within the operating area, the outputs can change from 0 V (or 0 A) to the rated output voltage (or rated output current).

You can specify the channels that will operate in tracking mode with CONFIG parameter CF09.

When set to tracking mode, parallel operation nor series operation can be used.

TRACKING 1 (absolute value change)

The outputs of target channels change to the same values (absolute values) along with the changes in the reference channel. When TRACKING 1 is enabled, the voltage and current set at that moment become the reference values, and changes are made from there.

If the output of a target channel reaches its maximum output setting or 0 V (or 0 A) when the voltage or current of the reference channel is changed, the display no longer changes but the amount of change in the target channel is recorded. When the output of the reference channel is returned to its original output value, the outputs of channels operating in tracking mode will also return to their original values. (See example 1.)

It is possible to change the reference channel during tracking operation. The state when the change is made becomes the reference, and the outputs change accordingly. (See example 2.)

It is possible to change the reference value of the reference channel during tracking operation. You can do this by selecting the reference channel with the SELECT key and changing the value.

Here we will use TRACKING 1 on CH1 and CH2 of a PMX32-2QU.

Example 1: Settings: CH1 = 25.00 V, CH2 = 30.00 V. The reference channel is set to CH1.

[CH1]	[CH2]	
25.00 V	30.00 V	Reference voltage Set TRACKING1.
		▶ Increase CH1 by 4 V.
29.00 V	32.00 V	CH2 stops at its maximum output, but the amount of change (30 V + 4 V = 34 V) is recorded.
		▶ Decrease CH1 by 1 V.
28.00 V	32.00 V	CH2 stays at 32 V because $34\text{ V} - 1\text{ V} = 33\text{ V}$.
		▶ Decrease CH1 by 2 V.
26.00 V	31.00 V	CH2 becomes $33\text{ V} - 2\text{ V} = 31\text{ V}$.
		▶ Decrease CH1 by 1 V.
25.00 V	30.00 V	The output returns to its original reference voltage.

Example 2: Settings: CH1 = 25.00 V, CH2 = 30.00 V. The reference channel is set to CH1 and changed to CH2 in the middle.

[CH1]	[CH2]	
25.00 V	30.00 V	Reference voltage Set TRACKING1.
		▶ Increase CH1 by 4 V.
29.00 V	32.00 V	CH2 stops at its maximum output, but the amount of change (30 V + 4 V = 34 V) is recorded.
		▶ Press SELECT to select CH2 to change the reference channel to CH2.
29.00 V	32.00 V	The reference voltage changes to 32.00 V, and the amount of change is cleared.
		▶ Decrease CH2 by 1 V.
28.00 V	31.00 V	CH2 becomes $32.00\text{ V} - 1\text{ V} = 31.00\text{ V}$.
		▶ Decrease CH2 by 1 V.
27.00 V	30.00 V	CH2 returns to its original reference voltage, but CH1 becomes 27.00 V and does not return to the original reference value.

■ Procedure for TRACKING 1 (absolute value change)

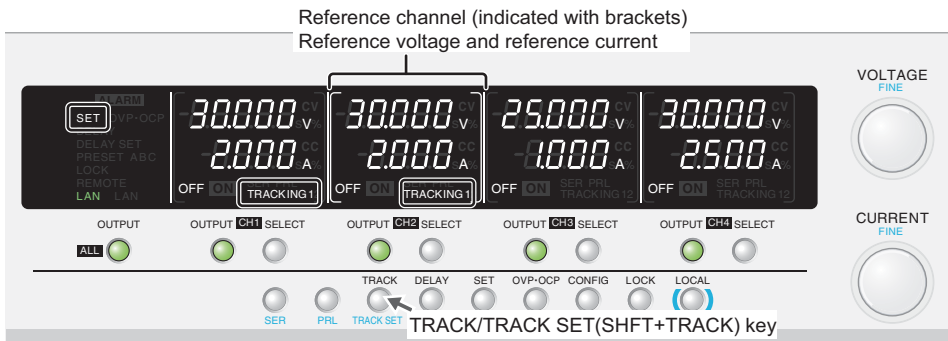

Example of PMX32-2QU (reference channel: CH2, TRACING 1 operation: CH1 and CH2)

- 1 Press **OUTPUT ALL** to turn off the output.
- 2 Using **CONFIG** settings, select the channels that will operate in tracking mode (CF09: OFF/ON) (p.47).
- 3 Set the output values of the channels that will operate in tracking mode.
- 4 Press **TRACK** to enter **TRACKING 1** mode. If **TRACKING 2** is displayed, press **TRACK SET (SHIFT+TRACK)** to change.
TRACKING 1 is shown in the display areas of the channels that will operate in tracking mode. Press TRACKING SET (SHIFT+TRACK) to switch between TRACKING 1 and TRACKING 2.
- 5 Press **SELECT** to select the reference channel for **TRACKING 1**.
The selected channel is indicated with brackets.
- 6 Press the **OUTPUT** key of the channel that will operate in tracking mode to turn the output on.
- 7 Based on the output of the reference channel, turn the rotary knob to set the desired output.

To clear the TRACKING 1 operation, press TRACK.

TRACKING 2 (percentage change)

The outputs of target channels change at the same percentage along with the changes in the reference channel. When TRACKING 2 is enabled, the voltage and current set on each channel at that moment become the reference values (100 %), and changes are made from there.

If the output of a target channel reaches its maximum output setting or 0 V (or 0 A) when the reference channel percentage is changed, the display no longer changes but the amount of change in the target channel is recorded. When the output is returned to its original value (100 %), the outputs of the target channels also return to their original values.

Example: Here we will use TRACKING 2 on CH1 and CH2 of a PMX32-2QU.

When you turn the rotary knob during tracking operation, the outputs change at the same percentage as the preset output percentage (b/a).

$$b/a = d/c$$

This proportional expression is satisfied.

Example when the voltage is changed within the rated output

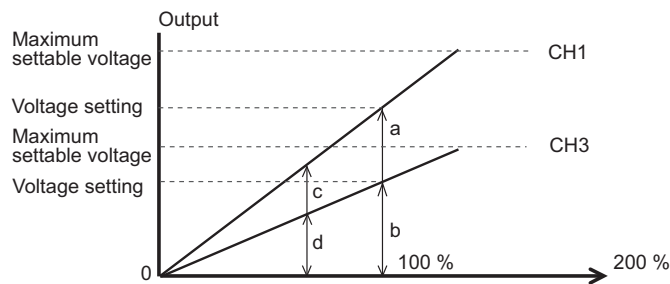

Example when the voltage is changed above the maximum settable output

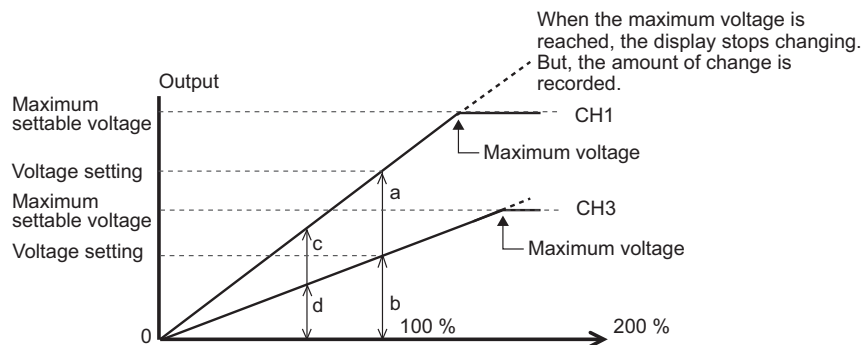

■ Procedure for TRACKING 2 (percentage change)

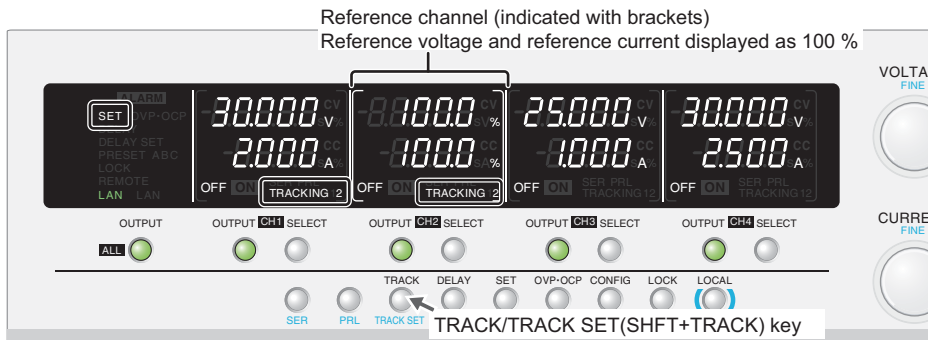

Example of PMX32-2QU (reference channel: CH2, TRACING 1 operation: CH1 and CH2)

- 1 Press OUTPUT ALL to turn off the output.
- 2 Using CONFIG settings, select the channels that will operate in tracking mode (CF09: OFF/ON) (p.47).
- 3 Set the output values of the channels that will operate in tracking mode.
- 4 Press TRACK to enter TRACKING 2 mode. If TRACKING 1 is displayed, press TRACK SET (SHIFT+TRACK) to change.
TRACKING 2 is shown in the display areas of the channels that will operate in tracking mode. Press TRACKING SET (SHIFT+TRACK) to switch between TRACKING 1 and TRACKING 2.
- 5 Press SELECT to select the reference channel for TRACKING 2.
The selected channel is indicated with brackets.
In the setting display, the voltmeter and ammeter show "100.0 %".
- 6 Press the OUTPUT key of the channel that will operate in tracking mode to turn the output on.
- 7 Based on the percentage of the reference channel, turn the rotary knob to set the desired output.
Press SET to switch between voltage/current display and percentage display.

To clear the TRACKING 2 operation, press TRACK.

Remote Control

You can remotely control the product from a PC using SCPI commands through the LAN, USB, or GPIB interface. Moreover, with the LAN interface, you can use the Web browser interface to remotely control the product from a virtual front panel. For details on remote control, see the Communication Interface Manual.

Switching from Remote Mode to Local Mode

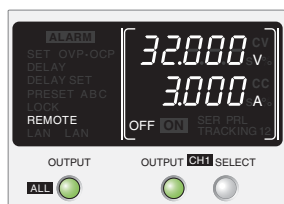

When the product is being controlled remotely, “REMOTE” is shown in the display area.

To switch the product back to local mode from the front panel, press LOCAL.

External Control

The CONTROL TERMINAL on the rear panel can be used to perform the following external controls.

- Turning output on and off using an external contact
- Alarm input using an external contact
- External monitoring of the operating status

CONTROL TERMINAL

The CONTROL TERMINAL is a screw-less terminal.

The parts necessary to connect to the CONTROL TERMINAL are not included. Use parts that match the connector to make the connections.

For information about how to obtain these tools or replacement parts, contact your Kikusui agent or distributor.

Connecting the CONTROL TERMINAL

■ Cables and tools that are necessary to make the connection

Wire	Single wire: $\varnothing 0.32$ (AWG28) to $\varnothing 0.81$ (AWG20) Stranded wire: 0.08 mm^2 (AWG28) to 0.52 mm^2 (AWG20)
Flat-blade screwdriver	Tip thickness: 0.5 mm
Wire stripper	A wire stripper that matches the wires listed above



WARNING Risk of electric shock and damage to internal circuits.

- Never connect to the CONTROL TERMINAL while the POWER switch is turned on.
- Insert the cables so that the wire strands do not touch the chassis when they stick out of the CONTROL TERMINAL. Also, insert the cables so that the stripped wires do not stick out of the terminal block.
- For connecting to the CONTROL TERMINAL, use cables with a voltage rating that is higher than the product's isolation voltage. For details on the isolation voltage of each model, see "Specifications" (p.85).

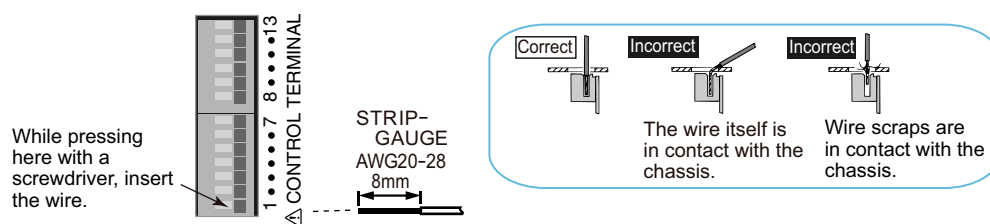

- 1 Turn the POWER switch off.
- 2 Remove 8 mm of the wire covering, and connect the wire to the CONTROL TERMINAL.
- 3 Remove the screwdriver, and check that the wire does not come loose.
This completes the connections.

Pin arrangement of the CONTROL TERMINAL

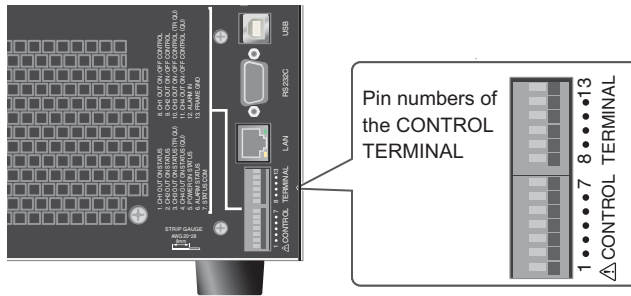

Pin no.	Signal name	Description
1	OUTPUT ON STATUS (CH1)	On when output is on (output through an open-collector photocoupler). ^{*1}
2	OUTPUT ON STATUS (CH2)	On when output is on (output through an open-collector photocoupler). ^{*1}
3	OUTPUT ON STATUS (CH3)	On when output is on (output through an open-collector photocoupler). ^{*1}
4	OUTPUT ON STATUS (CH4)	On when output is on (output through an open-collector photocoupler). ^{*1}
5	POWER ON STATUS	On when the power is on (output through an open-collector photocoupler). ^{*1}
6	ALARM STATUS	On when a protection function (OVP, OCP, OHP, WATCHDOG) is activated or when an alarm signal (ALARM IN) is received.
7	STATUS COM	Status signal common for pins 1 to 6.
8	OUTPUT ON/ OFF CONTROL (CH1)	Output on/off control using external contact input
9	OUTPUT ON/ OFF CONTROL (CH2)	Output on/off control using external contact input
10	OUTPUT ON/ OFF CONTROL (CH3)	Output on/off control using external contact input
11	OUTPUT ON/ OFF CONTROL (CH4)	Output on/off control using external contact input
12	ALARM IN	All channel outputs are turned off when an alarm signal is received.
13	FRAME GND	External signal common for pins 8 to 12. ^{*2}

*1. Open collector output: Maximum voltage of 30 V and maximum current of 8 mA. The status common is floating (isolation voltage or less). It is isolated from the control circuit.

*2. FRAME GND is connected to the chassis.

Output On/Off Control

This section explains how to use an external contact to control the output on and off states.

⚠ WARNING Risk of electric shock.

- Ensure that the insulation of external contact (S) and the connected cable is greater than or equal to the isolation voltage of the product. For details on the isolation voltage of each model, see “Specifications” (p.85).
- When using shielded cables for the connection, protect the uncovered sections of the shielded cable by using insulation tubes whose withstand voltage is greater than the PMX’s isolation voltage.

To reduce the influence of noise on the output, connect a 2-core shielded wire or a twisted-pair wire across the external contact, and keep the wire as short as possible. If the wiring is long, it becomes easy for noise to influence the operation of the PMX. Even if you use cables that are designed to suppress noise, the PMX may not operate properly.

If you use a shielded cable, connect the shield to the chassis or ground.

To use an external contact to control the output on and off states, set the appropriate CONFIG parameter (CF04: □□). Then, select the logic setting from the following two options.

- Turn the output on with a LOW level signal (CF05: L □)
When pin 8 (CH1), pin 9 (CH2), pin 10 (CH3), or pin 11 (CH4) of the CONTROL TERMINAL is set to LOW level (0 V to 0.5 V) or is shorted, the output is turned on.
- Turn the output on with a HIGH level signal (CF05: H □)
When pin 8 (CH1), pin 9 (CH2), pin 10 (CH3), or pin 11 (CH4) of the CONTROL TERMINAL is set to HIGH level (4.5 V to 5 V) or is opened, the output is turned on.

When you are using an external contact to control the output on and off states, the OUTPUT and OUTPUT ALL keys on the front panel are disabled.

If the delay function is enabled (“DELAY” is shown), you cannot use an external contact to control the output on and off states (CF04). Disable the delay function.

External contact connection

Pin 8 (CH1), pin 9 (CH2), pin 10 (CH3), or pin 11 (CH4) and pin 13 of the CONTROL TERMINAL are used.

The open-circuit voltage across pin 8 (CH1), pin 9 (CH2), pin 10 (CH3), or pin 11 (CH4) and 13 is approximately 3.5 V, and the short-circuit current is approximately 0.75 mA.

Use external contacts that have a contact rating greater than or equal to 1 mA at 5 Vdc.

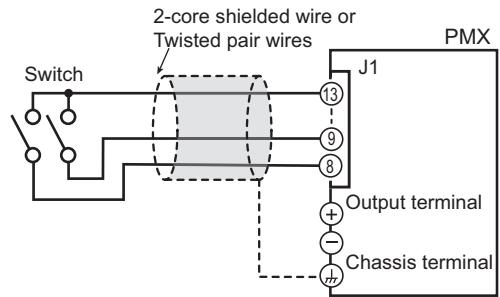

Example in which pin 8 (CH1) and pin 9 (CH2) are connected

■ For long-distance wiring

When you are wiring over a great distance, use a small relay and extend the coil side of the relay.

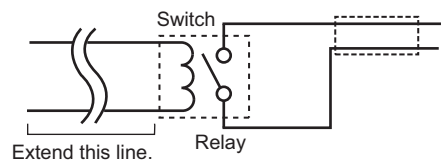

Alarm Input

This section explains how to use an alarm signal input through an external contact to turn the output off. To apply an alarm signal, short the contact switch for at least 0.5 s.

⚠ WARNING Risk of electric shock.

- Ensure that the insulation of external contact (S) and the connected cable is greater than or equal to the isolation voltage of the product. For details on the isolation voltage, see “Specifications” (p.85).
- When using shielded cables for the connection, protect the uncovered sections of the shielded cable by using insulation tubes whose withstand voltage is greater than the PMX’s isolation voltage.

To reduce the influence of noise on the output, connect a 2-core shielded wire or a twisted-pair wire across the external contact, and keep the wire as short as possible. If the wiring is long, it becomes easy for noise to influence the operation of the PMX. Even if you use cables that are designed to suppress noise, the PMX may not operate properly.

If you use a shielded cable, connect the shield to the chassis.

Alarm input connection

Pins 12 and 13 of the CONTROL TERMINAL are used. The open-circuit voltage across pins 12 and 13 is approximately 3.5 V, and the short-circuit current is approximately 0.75 mA.

Use external contacts that have a contact rating greater than or equal to 1 mA at 5 Vdc.

If two or more channels are floating, and you are using a single external contact to apply the alarm signal, use a relay or similar device for the external contact signal to isolate the signal transmitted to each channel.

■ For long-distance wiring

When you are wiring over a great distance, use a small relay and extend the coil side of the relay.

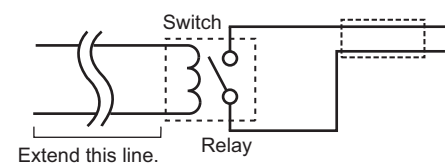
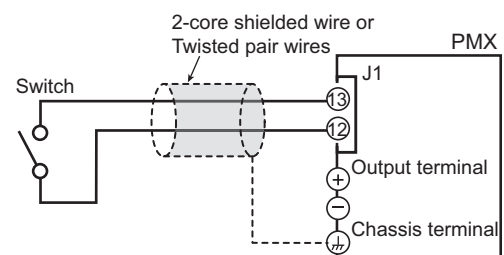

External monitoring of the operating status

The J1 connector has status outputs that can be used to externally monitor the operation status of the product. The following six items make up the status outputs.

The outputs are open collector outputs of photocouplers; they are isolated from the internal circuits of the product.

The status common is floating (that is, it has an isolation voltage of less than or equal to 70 V).

The maximum ratings of the signal terminals are as follows:

Maximum voltage: 30 V. Maximum current (sink): 8 mA.

Pin no.	Signal name	Description	Circuit
1	OUTPUT ON STATUS (CH1)	This is set to LOW level when the CH1 output is turned on. Photocoupler open collector output.	
2	OUTPUT ON STATUS (CH2)	This is set to LOW level when the CH2 output is turned on. Photocoupler open collector output.	
3	OUTPUT ON STATUS (CH3)	This is set to LOW level when the CH3 output is turned on. Photocoupler open collector output.	
4	OUTPUT ON STATUS (CH4)	This is set to LOW level when the CH4 output is turned on. Photocoupler open collector output.	
5	POWER ON STATUS	This is set to LOW level when the POWER switch is turned on (POWER ON STATUS). Photocoupler open collector output.	
6	ALARM STATUS	This is set to LOW level when a protection function (OVP, OCP, OHP, WATCHDOG) is activated or when an alarm signal (ALARM IN) is received.	
7	STATUS COM	Status signal common for pins 1 to 6. Photocoupler emitter output.	

Parallel Operation and Series Operation

Overview of Parallel Operation

CH1 and CH2 can be connected in parallel inside the product to double the current output range. CH2 operates as the master channel and CH1 as the slave channel.

In parallel operation, the output current is the total of the CH1 and CH2 outputs.

Parallel operation functions

Voltage display and current display

The voltage or current is displayed on CH2 (master). The total current of CH1 and CH2 is displayed.

The CH1 voltmeter shows "SLAVE."

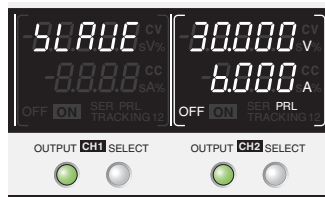

Panel display during parallel operation

Example when the output voltage is set to 30 V and the output current to 6 A (CH1: 3 A+CH2: 3 A)

Remote sensing

This is available [\(p.23\)](#).

The sensing terminal of CH2 (master) can be used.

Memory

This is available [\(p.52\)](#).

The values set on CH2 (master) during parallel operation can be saved and recalled.

For the other channels of PMX32-3TR/PMX32-2QU, the values are shared between normal operation, parallel operation, and series operation.

External control

This is available [\(p.60\)](#).

To perform output on/off control, use pin 9 (CH2) and pin 13. Open pin 8 (CH1).

Alarms

Alarms that are detected on a channel are also detected during parallel operation (p.37).

■ Clearing alarms

Press ALM CLR (SHIFT+SET), or turn the POWER switch off and then on. If you do not resolve the cause of the alarm, an alarm will occur again.

If an alarm still occurs even after you have resolved all the causes of alarms, the product may be malfunctioning. Stop using it immediately, and contact your Kikusui agent or distributor.

Connections for parallel operation

Connecting the Load

⚠ WARNING Risk of electric shock. Turn the POWER switch off before you touch the output terminals. Attach the output terminal cover after you finish wiring the load.

⚠ CAUTION

- If you are connecting the output terminal to the chassis terminal, be sure to connect the output terminal of one of the channels to the chassis terminal.
- To prevent oscillation, connect an electrolytic capacitor with a capacitance of a few hundred μF to a few ten thousand μF across the load as necessary. If the wires are long, the wiring inductance and capacitance can cause phase shifting at a level that can not be ignored. This may lead to oscillation. Use an electrolytic capacitor that has a withstand voltage that is at least 120 % of the rated output voltage.
- Twist the positive and negative cables together, and make the connection to the load as short as possible. Oscillation may occur as a result of wiring inductance.
- Connect the load wires to the CH2 output terminals. Connecting to CH1 can cause damage.

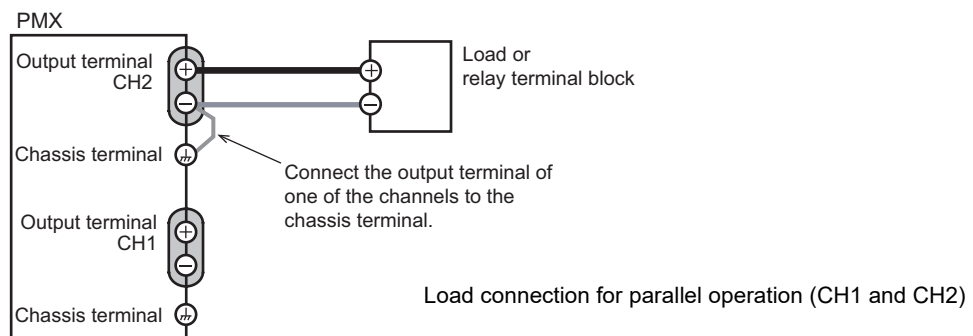

1 Turn the POWER switch off.

2 Connect the load cables (p.16) to the CH2 output terminals.

3 Connect the load cables of CH2 to the load.

Use load cables that have sufficient current capacity. If you are connecting to a relay terminal block, use wires with the same length and cross-sectional area, and wire them as short as possible (50 cm or less).

4 Connect a CH2 output terminal (positive or negative) to the chassis terminal with a short bar.

Ground the output terminal of only one of the channels. Do not ground the output terminals of both channels.

If you are using the units under floating conditions, do not connect the terminals.

5 Attach the output terminal cover.

This completes the connections.

Configuration for parallel operation

Setting the voltage and current

Set the voltage and current on CH2 (master). The current can be set up to double the current that is possible when operating independently.

Setting the overvoltage protection (OVP) and overcurrent protection (OCP)

Set the overvoltage protection (OVP) and overcurrent protection (OCP) on CH2 (master) ([p.38](#) , [p.39](#)).

Starting parallel operation

Turning on the POWER switch

Parallel operation cannot be used when the tracking function is enabled. Disable the tracking function.

1 Turn on the POWER switch of this product.

2 Press SHIFT+PRL to switch to parallel operation mode.

The CH1 voltmeter shows “SLAVE,” and the CH2 display area shows “P-L.” Switching is possible only when the output is off.

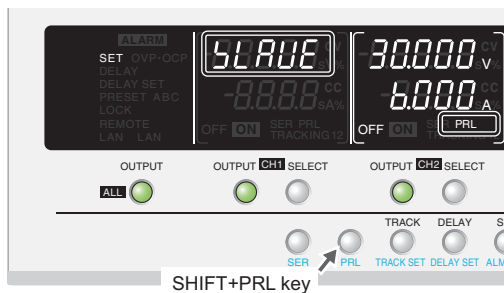

3 Press SELECT on CH2.

CH2 is indicated with brackets.

4 Turn the VOLTAGE knob to set the voltage and the CURRENT knob to set the current.

The CH2 display area shows the voltage and current.

5 Press OUTPUT on CH2 to turn output on.

Turning the POWER switch off

 **CAUTION**

If you want to turn the POWER switch back on, wait at least 10 seconds after the panel display turns off. Repeatedly turning the POWER switch on and off at short intervals will shorten the service life of the POWER switch and the internal input fuse.

- 1** Press **OUTPUT** on **CH2** or **OUTPUT ALL** to turn output off.
- 2** Press **SHIFT+PRL** to disable the parallel operation mode.
“**SLRUE**” disappears from the CH1 voltmeter and “**PRL**” from the CH2 display area.
- 3** Turn the **POWER** switch off.

Overview of Series Operation

CH1 and CH2 can be connected in series inside the product to double the voltage output range. CH2 operates as the master channel and CH1 as the slave channel. In series operation, the output voltage is the total of the CH1 and CH2 outputs.

NOTE

The specifications of this product are defined with the premise that CH1 and CH2 are connected in series internally. When used as positive and negative power supplies, the specifications may not be met. The current limit of the CH1 output terminal and that of CH2 (master) are different.

Series operation functions

Voltage display and current display

The voltage or current is displayed on CH2 (master). The voltage is the total voltage of CH1 and CH2. The CH1 voltmeter shows "LOAD".

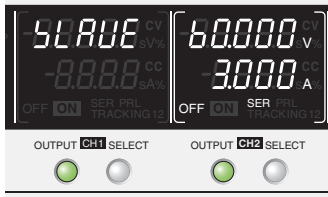

Panel display during series operation
Example when the output voltage is 60 V (CH1: 30 V+CH2: 30 V) and the output current is 3 A

Remote sensing

This is available (p.23).

CAUTION

The wiring for sensing is complicated when using remote sensing during series operation. Be careful to wire the cables correctly. Incorrect wiring can cause abnormal voltage output or damage to the product.

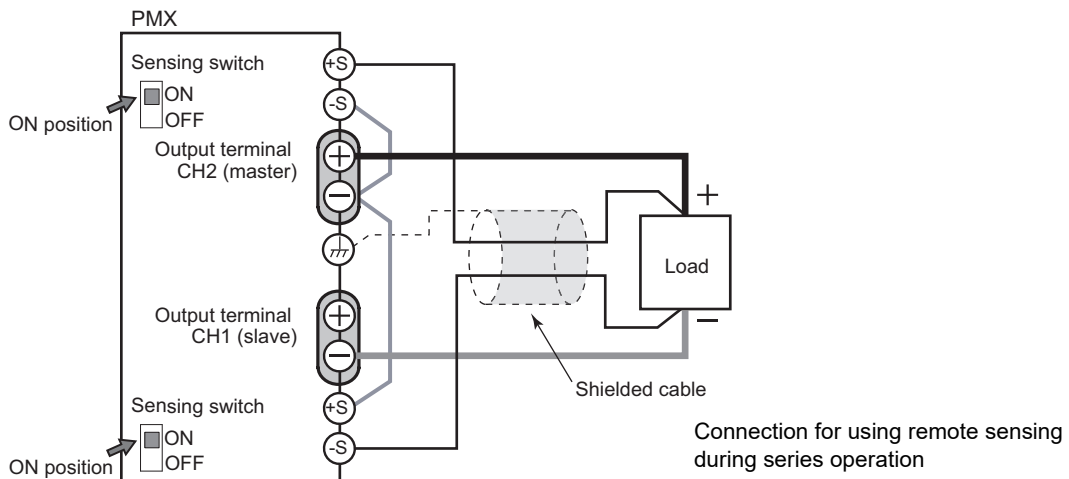

Memory

This is available [\(p.52\)](#).

The values set on CH2 (master) during series operation can be saved and recalled.

For the other channels of PMX32-3TR/PMX32-2QU, the values are shared between normal operation, parallel operation, and series operation.

External control

This is available [\(p.60\)](#).

To perform output on/off control, use pin 9 (CH2) and pin 13. Open pin 8 (CH1).

Alarms

Alarms that are detected on a channel are also detected during series operation [\(p.37\)](#).

■ Clearing alarms

After resolving the cause of the alarm, press ALM CLR (SHIFT+SET), or turn the POWER switch off and then on. If you do not resolve the cause of the alarm, an alarm will occur again.

If an alarm still occurs even after you have resolved all the causes of alarms, the product may be malfunctioning. Stop using it immediately, and contact your Kikusui agent or distributor.

Connection for series operation

Connecting the Load

⚠ WARNING Risk of electric shock. Turn the **POWER** switch off before you touch the output terminals. Attach the output terminal cover after you finish wiring the load.

⚠ CAUTION Risk of damage.

- If you are connecting the output terminal to the chassis terminal, connect the negative terminal of CH1 or the positive terminal of CH2 to the chassis terminal.
- The output terminals of CH1 and CH2 will output about half the specified output voltage (at no load). Connecting in a manner different from the figure below can offset the balance between the CH1 and CH2 output voltages and may damage the product.
- To prevent oscillation, connect an electrolytic capacitor with a capacitance of a few hundred μF to a few ten thousand μF across the load as necessary. If the wires are long, the wiring inductance and capacitance can cause phase shifting at a level that can not be ignored. This may lead to oscillation.
Use an electrolytic capacitor that has a withstand voltage that is at least 120 % of the rated output voltage.

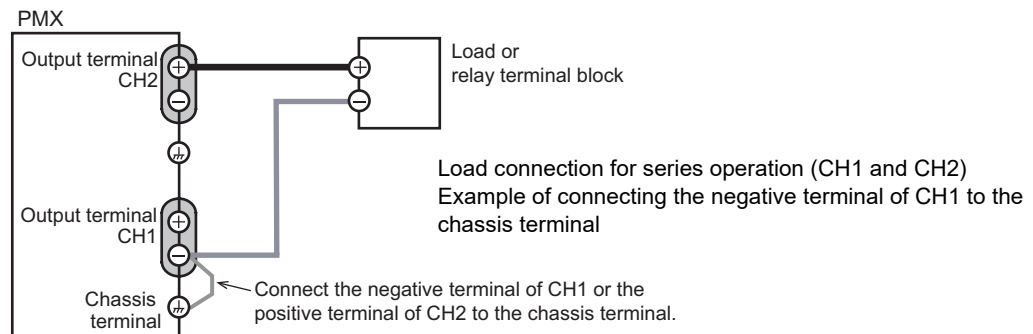

- 1 Turn the POWER switch off.**
- 2 Connect the load cables (p.16) to the CH1 and CH2 output terminals.**
- 3 Connect the load cables of CH1 and CH2 to the load.**
Use load cables that have sufficient current capacity. If you are connecting to a relay terminal block, use wires with the same length and cross-sectional area, and wire them as short as possible (50 cm or less). If the voltage drop in the load cable is large, the difference in electric potential and the load regulation become large.
- 4 Connect the negative terminal of CH1 or the positive terminal of CH2 to the chassis terminal with a short bar.**
Ground the output terminal of only one of the channels. Do not ground the output terminals of both channels.
Do not connect the positive terminal of CH1 or the negative terminal of CH2 to the chassis terminal.
- 5 Attach the output terminal cover.**
This completes the connections.

Configuration for series operation

Setting the voltage and current

Set the voltage and current on CH2 (master). The voltage can be set up to double the voltage that is possible when operating independently.

Setting the overvoltage protection (OVP) and overcurrent protection (OCP)

Set the overvoltage protection (OVP) and overcurrent protection (OCP) on CH2 (master) ([p.38](#) , [p.39](#)).

Starting series operation

Turning on the POWER switch

Series operation cannot be used when the tracking function is enabled. Disable the tracking function.

- 1 Turn on the POWER switch of this product.**
- 2 Press SHIFT+SER to switch to series operation mode.**
The CH1 voltmeter shows “SLAVE,” and the CH2 display area shows “SER.”
Switching is possible only when the output is off.

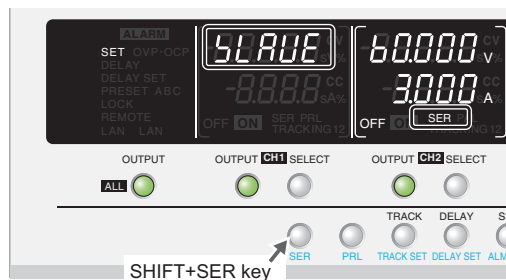

- 3 Press SELECT on CH2.**
CH2 is indicated with brackets.
- 4 Turn the VOLTAGE knob to set the voltage and the CURRENT knob to set the current.**
The CH2 display area shows the voltage and current.
- 5 Press OUTPUT on CH2 to turn output on.**

Turning the POWER switch off

⚠ CAUTION If you want to turn the POWER switch back on, wait at least 10 seconds after the panel display turns off. Repeatedly turning the POWER switch on and off at short intervals will shorten the service life of the POWER switch and the internal input fuse.

- 1** Press **OUTPUT** on **CH2** or **OUTPUT ALL** to turn output off.
- 2** Press **SHIFT+SER** to disable the series operation mode.
“**LRUE**” disappears from the CH1 voltmeter and “**SE**” from the CH2 display area.
- 3** Turn the **POWER** switch off.

Maintenance

The product is calibrated before shipment. We recommend periodic calibration to maintain the performance over an extended period.

For calibration, we recommend that you ask your Kikusui agent or distributor.

If you want to calibrate the product yourself, follow the procedure below.

Calibration overview

There are 14 calibration parameters.

Calibration is performed for 1 % and 100 % of full scale.

Voltage	Current
Output voltage offset (1 % of the rated voltage)	Output current offset (1 % of the rated current)
Output voltage full scale (100 % of the rated voltage)	Output current full scale (100 % of the rated current)
Voltmeter offset (1 % of the rated voltage)	Ammeter offset (1 % of the rated current)
Voltmeter full scale (100 % of the rated voltage)	Ammeter full scale (100 % of the rated current)
Overvoltage protection (OVP)	Overcurrent protection (OCP)
Output voltage offset in series operation (1 % of the rated voltage)	Output current offset in parallel operation (1 % of the rated current)
Output voltage full scale in series operation (100 % of the rated voltage)	Output current full scale in parallel operation (100 % of the rated current)

Test Equipment Required

- A DC voltmeter (DVM) with a measurement accuracy of 0.01 % or better
- A shunt resistor with an accuracy of 0.1 % or better, or an ammeter that can supply the rated output current of the product to be calibrated

Environment

Perform calibration under the following environment.

- Temperature: 23 °C ± 5 °C
- Humidity: 80 %rh or less

To minimize the calibration error due to initial drift, warm up the product (with the current running) for at least 30 minutes before calibration. In addition, warm up the DVM and shunt resistor for as long as is necessary.

Connection

⚠ WARNING Risk of electric shock.

- Turn the **POWER** switch off before you touch the output terminals.
- Connect the output terminal to the chassis terminal.

Connection for voltage calibration

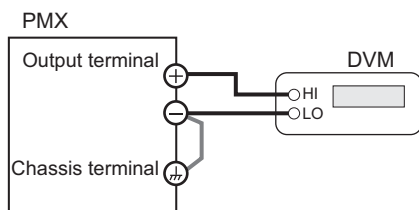

- 1** Turn the **POWER** switch off.
- 2** Connect a DVM to the output terminals.

Connection for current calibration

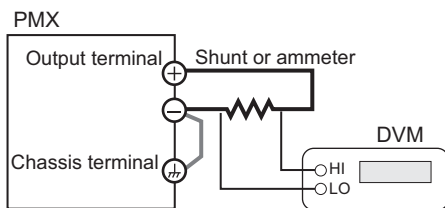

- 1** Turn the **POWER** switch off.
- 2** Connect a shunt or ammeter to the output terminals, and connect a DVM across it.

Calibration procedure

Calibrate each channel.

NOTE

The offset and full scale values affect all calibration parameters. Be sure to calibrate both the offset and full scale values.

1 While holding down SET and LOCAL, turn the POWER switch on.



The product starts in calibration mode.

The voltmeter displays the calibration parameter, and the ammeter displays the calibration data. Only during voltmeter calibration, the voltmeter displays the calibration data and the ammeter the calibration parameter.

2 Press SELECT to select the channel you want to calibrate.

3 Calibrate by following the procedure for each calibration parameter.

You can change the resolution of the CURRENT knob (p.28).

	Calibration parameter	5U-6 (p.80)	Output voltage offset
	Calibration data	5U-6 (p.80)	Output voltage full scale
<p>Example of a voltmeter calibration display</p> 	Calibration data	dU-6 (p.80)	Voltmeter offset
	Calibration parameter	dU-6 (p.80)	Voltmeter full scale
<p>Display for saving the calibration information (blinking)</p> 	Calibration	dC-6 (p.81)	Ammeter offset
	Saving calibration information	dC-6 (p.81)	Ammeter full scale
		oUPC (p.80)	Overvoltage protection (OVP)
		oCPC (p.81)	Overcurrent protection (OCP)

4 Press SET to make “CAL” blink on the voltmeter and “SAVE” blink on the ammeter.

5 To save the calibration data, press SET again. Otherwise, press LOCK.

The blinking stops, and the product returns to calibration mode.

6 To finish calibration, turn off the POWER switch.

Output voltage calibration (offset and full scale)

- 1 Press **SELECT** to select the channel you want to calibrate.
- 2 Use the **VOLTAGE** knob to select **5U-b**, and turn on the output.
- 3 Turn the **CURRENT** knob to set the DVM reading to 1 % of the rated output voltage.
- 4 Use the **VOLTAGE** knob to select **5U-E**, and turn on the output.
- 5 Turn the **CURRENT** knob to set the DVM reading to 100 % of the rated output voltage.



Voltmeter calibration (offset, full scale, and OVP)

Be sure to calibrate the output voltage before calibrating the voltmeter.

- 1 Press **SELECT** to select the channel you want to calibrate.
- 2 Use the **VOLTAGE** knob to select **8U-b**, and turn on the output.
- 3 Turn the **CURRENT** knob to match the product's voltage reading to the DVM reading.
- 4 Use the **VOLTAGE** knob to select **8U-E**, and turn on the output.
- 5 Turn the **CURRENT** knob to match the product's voltage reading to the DVM reading.
- 6 Turn the **VOLTAGE** knob to select **8UPC**.
- 7 Press **OVP•OCP**.
Calibration is performed automatically. The voltmeter and ammeter displays change during this process.
- 8 If the calibration completes successfully, the ammeter displays "done."
If it doesn't, the ammeter displays "FR IL."
If the calibration ends with any other display, contact your Kikusui agent or distributor.

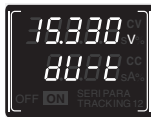

NOTE

If you press **OUTPUT ALL** during the calibration, the OVP calibration ends, and the ammeter displays "FR IL."

Output current calibration (offset and full scale)

- 1 Press SELECT to select the channel you want to calibrate.
- 2 Use the VOLTAGE knob to select $\Delta C - b$, and turn on the output.
- 3 Turn the CURRENT knob to set the DVM reading (converted current value) to 1 % of the rated output current.
- 4 Use the VOLTAGE knob to select $\Delta C - E$, and turn on the output.
- 5 Turn the CURRENT knob to set the DVM reading (converted current value) to 100 % of the rated output current.

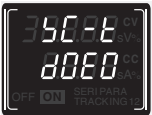

Ammeter calibration (offset, full scale, and OCP)

Be sure to calibrate the output current before calibrating the ammeter.

- 1 Press SELECT to select the channel you want to calibrate.
- 2 Use the VOLTAGE knob to select $\Delta C - b$, and turn on the output.
- 3 Turn the CURRENT knob to match the product's current reading to the DVM reading.
- 4 Use the VOLTAGE knob to select $\Delta C - E$, and turn on the output.
- 5 Turn the CURRENT knob to match the product's current reading to the DVM reading (converted current value).
- 6 Turn the VOLTAGE knob to select $\Delta C - PC$.
- 7 Press OVP•OCP.
Calibration is performed automatically. The voltmeter and ammeter displays change during this process.
- 8 If the calibration completes successfully, the ammeter displays "done."
If it doesn't, the ammeter displays "FR IL."
If the calibration ends with any other display, contact your Kikusui agent or distributor.

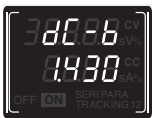

NOTE

If you press OUTPUT ALL during the calibration, the OCP calibration ends, and the ammeter displays "FR IL."

Connection (series operation and parallel operation)

⚠ WARNING Risk of electric shock.

- Turn the **POWER** switch off before you touch the output terminals.
- Connect the output terminal to the chassis terminal.

Connection for voltage calibration (for series operation)

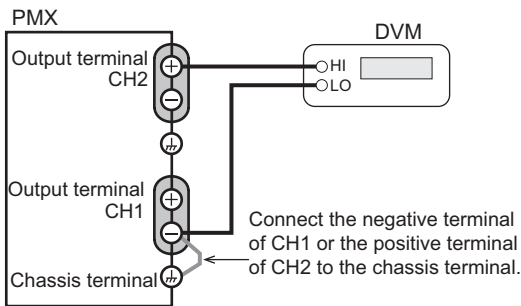

- 1 Turn the **POWER** switch off.
- 2 Connect a DVM to the output terminals.

Connection for current calibration (for parallel operation)

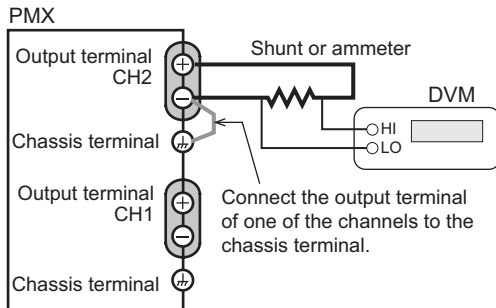

- 1 Turn the **POWER** switch off.
- 2 Connect a shunt or ammeter to the output terminals, and connect a DVM across it.

Calibration procedure (series operation and parallel operation)

Calibrate CH2 (master).

NOTE

The offset and full scale values affect all calibration parameters.
Be sure to calibrate both the offset and full scale values.

- 1** While holding down **SET** and **LOCAL**, turn the **POWER** switch on.
The product starts in calibration mode.
The voltmeter displays the calibration parameter, and the ammeter displays the calibration data.
- 2** To select voltage calibration for series operation, press **SHIFT+SER**. To select current calibration for parallel operation, press **SHIFT+PRL**.
- 3** Calibrate by following the procedure for each calibration parameter.
You can change the resolution of the **CURRENT** knob (p.28).

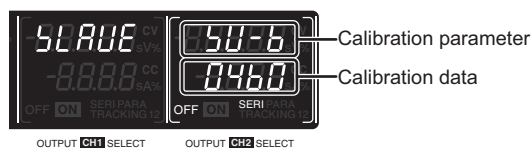

Output voltage offset display (for series operation)



Display for saving calibration data (blinking)

- 4** Press **SHIFT+SER** or **SHIFT+PRL** to return to the calibration screen for normal operation.
- 5** Press **SET** to make “**CAL**” blink on the CH2 voltmeter and “**SLAVE**” blink on the ammeter.
- 6** To save the calibration data, press **SET** again.
Otherwise, press **LOCK**.
The blinking stops, and the product returns to calibration screen.
- 7** To finish calibration, turn off the **POWER** switch.

Voltage calibration for series operation (offset and full scale)

- 1** Use the VOLTAGE knob to select 50-b , and turn on the CH2 output.
- 2** Turn the CURRENT knob to set the DVM reading to 1 % of the rated output voltage.
- 3** Use the VOLTAGE knob to select 50-c , and turn on the CH2 output.
- 4** Turn the CURRENT knob to set the DVM reading to 100 % of the rated output voltage.

Current calibration for parallel operation (offset and full scale)

- 1** Use the VOLTAGEob to select 50-b , and turn on the CH2 output.
- 2** Turn the CURRENT knob to set the DVM reading (converted current value) to 1 % of the rated output current. kn
- 3** Use the VOLTAGE knob to select 50-c , and turn on the CH2 output.
- 4** Turn the CURRENT knob to set the DVM reading (converted current value) to 100 % of the rated output current.

Specifications

Unless specified otherwise, the specifications are for the following settings and conditions.

- Loads are purely resistive loads.
- The product is warmed up for at least 30 minutes.
- The negative output is connected to the chassis terminal with a short bar.
- Values indicated by “TYP” are typical values. These values do not guarantee the performance of the PMX series (multiple-output).
- rating: Indicates the rated.
- set: Indicates a setting.
- reading: Indicates the readout value.
- Rated load and no load are defined as follows:

In constant-voltage mode (when the output current is set to a value greater than or equal to the maximum output current with rated output voltage)

Rated load: Refers to a resistive load that, when the rated output voltage is applied, makes the flowing current 95 % to 100 % of the maximum output current with rated output voltage.

No load: Refers to a load through which no output current flows. In other words, refers to an open load (no load being connected).

In constant-current mode (when the output voltage is set to a value greater than or equal to the maximum output voltage with rated output current)

Rated load: Refers to a resistive load that, when the rated output current flows, makes the voltage drop to 95 % to 100 % of the maximum output voltage with rated output current. Including the voltage drop in the load cables, the product’s output voltage must not exceed the maximum output voltage with rated output current.

No load: Refers to a resistive load that, when the rated output current flows, makes the voltage drop to 10 % of the maximum output voltage with rated output current or 1 V whichever is higher.

AC input

	PMX32-3DU	PMX32-3TR	PMX32-2QU
Nominal input rating	217 Vac ^{*1} , 50 Hz/ 60 Hz, single phase		
Input voltage range	± 10 %		
Input frequency range	47 Hz to 63 Hz		
Inrush current (MAX) ^{*2}	150 A	150 A	150 A
Power (MAX)	700 VA	900 VA	800 VA

*1. 100 Vac, 117 Vac, 200 Vac, and 234 Vac are factory options.

*2. Excludes the charge current component that flows through the capacitor of the internal EMC filter circuit immediately after the POWER switch is turned on (for approximately 1 ms).

Output

			PMX32-3DU	PMX32-3TR	PMX32-2QU
Rating	Output voltage	CH1	32.000 V	32.000 V	32.000 V
		CH2	32.000 V	32.000 V	32.000 V
		CH3	—	6.000 V	18.000 V
		CH4	—	—	18.000 V
	Output current	CH1	3.000 A	3.000 A	2.000 A
		CH2	3.000 A	3.000 A	2.000 A
		CH3	—	5.000 A	2.500 A
		CH4	—	—	2.500 A
Constant voltage	Maximum voltage setting	CH1	33.600 V	33.600 V	33.600 V
		CH2	33.600 V	33.600 V	33.600 V
		CH3	—	6.300 V	18.900 V
		CH4	—	—	18.900 V
	Resolution		1 mV		
	Voltage setting accuracy ^{*1}		±(0.03 % set +5 mV)		
	Input line regulation ^{*2}	CH1	3 mV	3 mV	3 mV
		CH2	3 mV	3 mV	3 mV
		CH3	—	1 mV	1 mV
		CH4	—	—	1 mV
	Load regulation ^{*3}	CH1	4 mV	4 mV	2 mV
		CH2	4 mV	4 mV	2 mV
CH3		—	5 mV	3 mV	
CH4		—	—	3 mV	
Transient response ^{*4}		50 μs			
Ripple noise (rms) ^{*5}		500 μV			
Command delay		80 ms			
Rise time (at rated load) ^{*6}		10 ms ±30 %			
Fall time (at no load) ^{*7}	CH1	350 ms ±30 %	350 ms ±30 %	350 ms ±30 %	
	CH2	350 ms ±30 %	350 ms ±30 %	350 ms ±30 %	
	CH3	—	220 ms ±30 %	240 ms ±30 %	
	CH4	—	—	240 ms ±30 %	
Temperature coefficient (TYP)		100 ppm/ °C			

			PMX32-3DU	PMX32-3TR	PMX32-2QU
constant current	Maximum current setting	CH1	3.150 A	3.150 A	2.100 A
		CH2	3.150 A	3.150 A	2.100 A
		CH3	—	5.250 A	2.625 A
		CH4	—	—	2.625 A
	Resolution		0.1 mA		
	Current setting accuracy* ¹		±(0.3 % set +0.1 % rating)		
	Input line regulation* ²		0.01 % + 0.25 mA		
	Load regulation* ⁸		5 mA		
	Ripple noise (rms) * ⁵	CH1	1 mA	1 mA	1 mA
		CH2	1 mA	1 mA	1 mA
CH3		—	2 mA	1 mA	
CH4		—	—	1 mA	
Temperature coefficient (TYP)		200 ppm/ °C			

*1. At an ambient temperature of 23 °C±5 °C.

*2. 90 % to 100 % or 100 % to 110 % of the nominal input voltage rating, rated load.

*3. The amount of change that occurs when the load is changed from no load to rated load at the rated output voltage. The value is measured at the sensing point.

*4. The amount of time required for the output voltage to return to a value within "rated output voltage ± (0.05 % + 10 mV)." When the load current is changed from 10 % to 100 % of the rated output current. The value is measured at the sensing point.

*5. When the measurement frequency bandwidth is 5 Hz to 1 MHz.

*6. The time for the output voltage to rise from 10 % to 90 % of the rating when the output is turned on.

*7. The time for the output voltage to fall from 90 % to 10 % of the rating when the output is turned off.

*8. The amount of current change when the load is changed from 10 % of the rated voltage or 1 V, whichever is higher, to the rated voltage at rated output current.

Display function

		PMX32-3DU	PMX32-3TR	PMX32-2QU
Voltmeter	Maximum display	99.999 (fixed decimal point)		
	Display accuracy *1	±(0.1 % of reading +10 mV)		
Ammeter	Maximum display	9.999 (fixed decimal point)		
	Display accuracy *1	±(0.2 % of reading +5 mA)		
Operation display	OUTPUT ON/OFF	Output on: "ON" display (green) Output off: "OFF" display		
	Output-on delay/ off delay	Displays "DELAY SET" when set. "DELAY" blinks during output-on delay/ off delay. "DELAY" is displayed after the output-on delay/off delay has passed.		
	CV operation	"CV" display (green)		
	CC operation	"CC" display (red)		
	Alarm operation	Displays "ALARM" (red) when a protection function is activated.		
	Memory	Displays "PRESET A," "PRESET B," or "PRESET C" when a memory area is in use.		
	key lock	Displays "LOCK" when the keys are locked.		
	Tracking	Displays "TRACKING 1" or "TRACKING 2" when tracking is in operation.		
	Remote operation	Displays "REMOTE" during remote control.		
	LAN operation	Displays or blinks "LAN" (depending on the status). <ul style="list-style-type: none"> • No fault status: Lights green. • Fault status: Lights green. • Standby status: Blinks red. • WEB identify status: Blinks green. 		

*1. At an ambient temperature of 23 °C±5 °C.

Protection function

		PMX32-3DU	PMX32-3TR	PMX32-2QU
Overvoltage protection (OVP)	Action	Turns the output off, displays "OVP," and displays "ALARM" (red).		
	Setting range	10 % to 110 % of the rated output voltage		
	Setting accuracy	$\pm(1 \text{ \% of rating})$		
	Resolution	1 mV		
Overcurrent protection (OCP)	Action ^{*1}	Turns the output off, displays "OCP," and displays "ALARM" (red).		
	Setting range	10 % to 110 % of the rated output current		
	Setting accuracy	$\pm(1 \text{ \% of rating})$		
	Resolution	0.1 mA		
Overheat protection (OHP)	Action	Turns the output off, displays "OHP," and displays "ALARM" (red).		
Communication monitoring (WATCHDOG)	Action	Turns the output off, displays "WDOG," and displays "ALARM" (red).		
Alarm signal input (ALARM IN)	Action	Turns the output off, displays "IN," and displays "ALARM" (red).		

*1. This does not protect against the discharge current peak that is generated from the capacitors inside the product's output section when the load is changed suddenly.

Signal output

		Common specifications
Status Signal output ^{*1}	OUTPUT ON STATUS	On when output is on.
	ALARM STATUS	On when an alarm is activated (OVP, OCP, OHP, WATCHDOG, ALARM IN).
	POWER ON STATUS	Turns on when the power is turned on

*1. Photocoupler open collector output; Maximum voltage 30 V, maximum current (sink) 8 mA. Isolated from the output and control circuits. The status common is floating (within the isolation voltage).

Control functions

		Common specifications
External control	Output on/off control (OUTPUT ON/OFF CONT)	Logic selectable: <ul style="list-style-type: none"> • Negative logic Output on when set to LOW (0 V to 0.5 V) or shorted; output off when set to HIGH (4.5 V or 5 V) or open • Positive logic Output on when set to HIGH (4.5 V to 5 V) or open; output off when set to LOW (0 V or 0.5 V) or shorted
	Alarm input (ALARM IN)	The output turns off with an alarm signal input (the contact switch shorted for at least 0.5 s).

Sensing

	Common specifications
Sensing	0.6 V for a single line (but the output terminals are controlled at the rated voltage)

Parallel operation and series operation

		PMX32-3DU	PMX32-3TR	PMX32-2QU
Parallel operation				
Applicable channels		Master: CH2, slave: CH1		
Constant voltage	Operating range	0 V to 32 V		
	Setting range	0 V to 33.6 V		
	Setting accuracy ^{*1}	0.3 % set + 0.1 % rating		
	Resolution	1 mV		
constant current	Operating range	0 A to 6 A	0 A to 4 A	
	Setting range	0 A to 6.3 A	0 A to 4.2 A	
	Setting accuracy ^{*1}	0.4 % set + 0.1 % rating		
	Resolution	0.2 mA		
Voltmeter	Maximum display	99.999 (fixed decimal point)		
	Display accuracy ^{*1}	±(0.5 % of reading + 10 digit)		
Ammeter	Maximum display	9.999 (fixed decimal point)		
	Display accuracy ^{*1}	±(1 % of reading + 10 digit)		
Series operation				
Applicable channels		Master: CH2, slave: CH1		
Constant voltage	Operating range	0 V to 64 V		
	Setting range	0 V to 67.2 V		
	Setting accuracy ^{*1, *2}	0.3 % set + 0.1 % rating		
	Resolution	2 mV		
constant current	Operating range	0 A to 3 A	0 A to 2 A	
	Setting range	0 A to 3.15 A	0 A to 2.1 A	
	Setting accuracy ^{*1}	0.4 % set + 0.1 % rating		
	Resolution	0.1 mA		
Voltmeter	Maximum display	99.999 (fixed decimal point)		
	Display accuracy ^{*1, *2}	±(0.5 % of reading + 20 digit)		
Ammeter	Maximum display	9.999 (fixed decimal point)		
	Display accuracy ^{*1}	±(1 % of reading + 5 digit)		

*1. At an ambient temperature of 23 °C±5 °C.

*2. The value is measured at the sensing point.

Other functions

		Common specifications
Output-on delay/ off delay		
Applicable channels		All channels
Setup		Set the output on/off delay time.
Setting range		0.1 s to 99.9 s
Resolution		0.1 s
Setting accuracy*1		±50 ms
Memory		Saves three combinations of voltage, current, OVP, OCP, and output-on delay/ off delay settings.
key lock		Selectable from the following three modes. <ul style="list-style-type: none"> • Loc1: Lock all keys except the OUTPUT and memory A, B, and C keys. • Loc2: Lock all keys except the OUTPUT key. • Loc3: Lock all keys and the rotary knob.
Tracking		
Applicable channels		All channels
Operation mode	Tracking function 1*2	Absolute value change
	Tracking function 2*3	Percentage change
Setting accuracy	CV setting accuracy	0.4 % of rating + 40 mV
	CC setting accuracy	0.7 % of rating + 10 mA

- *1. The difference between the time from when the reference output reaches 50 % of the setting to when the target output reaches 50 % of the setting and the delay time setting.
- *2. In tracking function 1, the output can be varied within the output range of the reference channel voltage or current.
- *3. In tracking function 2, the output can be varied at the same percentage as the reference output in reference to the output at the start of the tracking function.

Interface

Item		Common specifications
Common specifications	Software protocol	IEEE Std 488.2-1992
	Command language	Complies with SCPI Specification 1990.0
RS232C	Hardware	Complies with the EIA232D specifications (excluding the terminal block) D-sub 9-pin terminal block (male) Baudrate: 1200, 2400, 4800, 9600, 19200, 38400, 57600, 115200 bps Data length: 8 bits, Stop bits: 1 bit, Parity bit: None Flow control: No
	Program message terminator	LF during reception, LF during transmission.
USB	Hardware	Standard type B socket. Complies with the USB 2.0 specifications; data rate: 12 Mbps (full speed)
	Program message terminator	LF or EOM during reception, LF + EOM during transmission.
	Device class	Complies with the USBTMC-USB488 device class specifications.
LAN	Hardware	IEEE 802,3 100Base-TX/10Base-T Ethernet IPv4, RJ-45 terminal block
	Compliant standards	LXI Device Specification 2016 LXI HiSLIP Extended Function Rev. 1.0 LXI VXI-11 Extended Function Rev. 1.0
	Communication protocol	VXI-11, HiSLIP, SCPI-RAW, SCPI-Telnet
	Message terminator	VXI-11, HiSLIP: LF or END during reception, LF + END during transmission. SCPI-RAW: LF during reception, LF during transmission.

General specifications

Item	PMX32-3DU	PMX32-3TR	PMX32-2QU
Weight (main unit only)	Approx. 13 kg (28.66 lb)		
Dimensions	See the outline drawing (p.95).		
Environmental conditions	Operating temperature range	0 °C to 40 °C (32 °F to 104 °F)	
	Operating humidity range	20 %rh to 85 %rh (no condensation)	
	Storage temperature range:	-25 °C to 70 °C (13 °F to 158 °F)	
	Storage humidity range:	90 %rh or less (no condensation)	
	Installation location	Indoor use, altitude of up to 2000 m, overvoltage category II	
Isolation voltage	Between channels	±70 Vdc	
	Between the output and chassis	±70 Vdc	
Withstanding voltage	Between the primary circuit and chassis	No abnormalities at 1500 Vac for 1 minute.	
	Between the primary and secondary circuits	No abnormalities at 2600 Vac for 1 minute.	
	Between the secondary circuit and chassis	No abnormalities at 1500 Vdc for 1 minute.	
Insulation resistance	Between the primary circuit and chassis	500 Vdc, 30 MΩ or greater	
	Between the primary and secondary circuits		
	Between the secondary circuit and chassis		
	Between channels		
Cooling method	Forced air cooling using a fan motor		
Common	All channels are independent.		
Grounding polarity	Negative grounding or positive grounding possible		
Accessories	See (p.3).		
Electromagnetic compatibility ^{*1*2}	<p>Complies with the requirements of the following directive and standards.</p> <p>EMC Directive 2014/30/EU</p> <p>EN 61326-1 (Class A^{*3})</p> <p>EN 55011 (Class A^{*3}, Group 1^{*4})</p> <p>EN 61000-3-2</p> <p>EN 61000-3-3</p> <p>Applicable under the following conditions</p> <p>The maximum length of all cabling and wiring connected to the product must be less than 3 m.</p>		
Safety ^{*1}	<p>Complies with the requirements of the following directive and standards.</p> <p>EMC Directive 2014/35/EU^{*2}</p> <p>EN 61010-1 (Class I^{*5}, Pollution Degree 2^{*6})</p>		

*1. Does not apply to specially ordered or modified products.

*2. Only on models that have the CE marking on the panel.

- *3. This product conforms to Class A. This product is intended for use in an industrial environment. This product may cause interference if used in residential areas. Such use must be avoided unless the user takes special measures to reduce electromagnetic emissions to prevent interference to the reception of radio and television broadcasts.
- *4. This is a Group 1 instrument. This product does not generate and/or use intentionally radio-frequency energy, in the form of electromagnetic radiation, inductive and/or capacitive coupling, for the treatment of material or inspection/analysis purpose.
- *5. This product conforms to Class I. Be sure to ground the protective conductor terminal of this product. If not grounded properly, safety is not guaranteed.
- *6. Pollution is addition of foreign matter (solid, liquid or gaseous) that may produce a reduction of dielectric strength or surface resistivity. Pollution Degree 2 assumes that only non-conductive pollution will occur except for an occasional temporary conductivity caused by condensation.

External dimensions

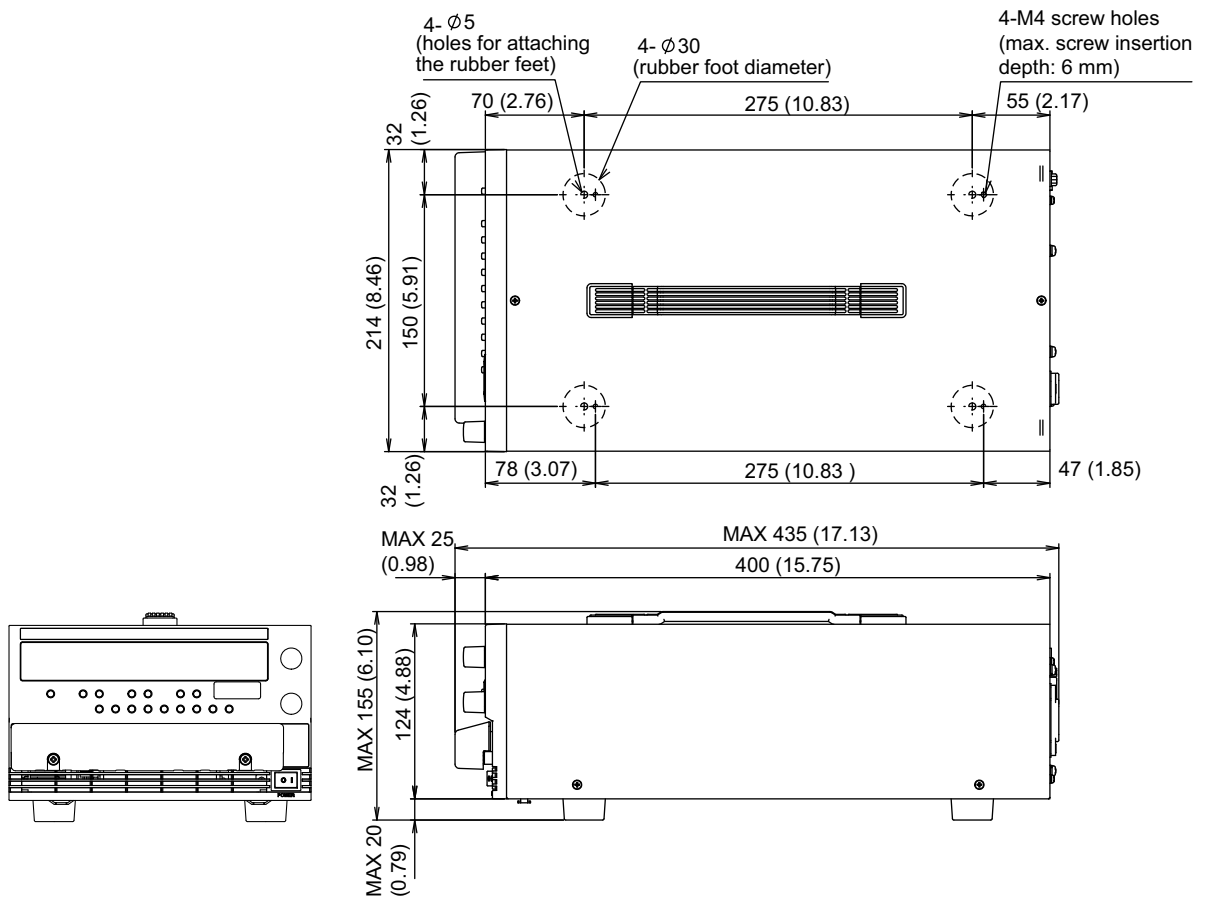

Unit: mm (inches)

PMX32-3DU/ PMX32-3TR/ PMX32-2QU External dimensions

Factory Default Settings

If you hold down LOCAL and LOCK and turn the POWER switch on, the product will be initialized to its factory default settings.

The voltmeter displays “ 0.00V ” and the product is set to factory default settings.

■ Basic settings

Basic item	Description
Output voltage	0 V
Output current	Maximum settable current
OVP (overvoltage protection)	110 % of the rated output voltage
OCP (overcurrent protection)	110 % of the rated output current
Memory values A, B, C	Output voltage, output current, OVP, OCP: Factory default settings output-on delay/ off delay time: 0.0 s

■ CONFIG settings

Parameter number	Setting/ display	Description
CF01	Output state at power-on	SAFE (output off)
CF02	Memory content display	ON (displayed)
CF03	Key lock content	LOC3 (Lock all keys and the rotary knob)
CF04*1	External control for turning output on/off	OFF (not controlled)
CF05*1	External control logic for turning output on/off	LO (a LOW signal turns output on)
CF06*1	Output-on startup state	CV (CV is prioritized)
CF07*1	Rise time when a value is changed	SLOW (the output voltage rises in 100 ms)
CF08	Output state when a protection function (OVP/OCP) is activated	ALL (all channels off)
CF09*1	Tracking operation	CH1 on, CH2 on
CF20	LAN interface	ON (use)
CF21	USB interface	ON (use)
CF22	RS232C interface	ON (use)
CF23	SCPI communication error display	OFF (not displayed)
CF24	Communication monitoring (watchdog) timer	OFF (timer off)
CF25	Buzzer on/off	ON (Buzzer on)
CF40	LAN setting reset (LCI/DEF)/apply (APPL)	LCI (LAN interface setting reset)
CF41	IP address assignment method	110 (DHCP on, AUTO IP on, MANUAL IP off)
CF46	IP address subnet mask	24
CF51	RS232C baud rate	19.2 (kbps)

*1. Can be set separately for each channel

Options

This product has the following options.

For information about options, contact your Kikusui agent or distributor.

Rack mounting options

Name	Model	Note
Rack mount adapter	KRA3	For EIA inch racks
	KRA150	For JIS millimeter racks

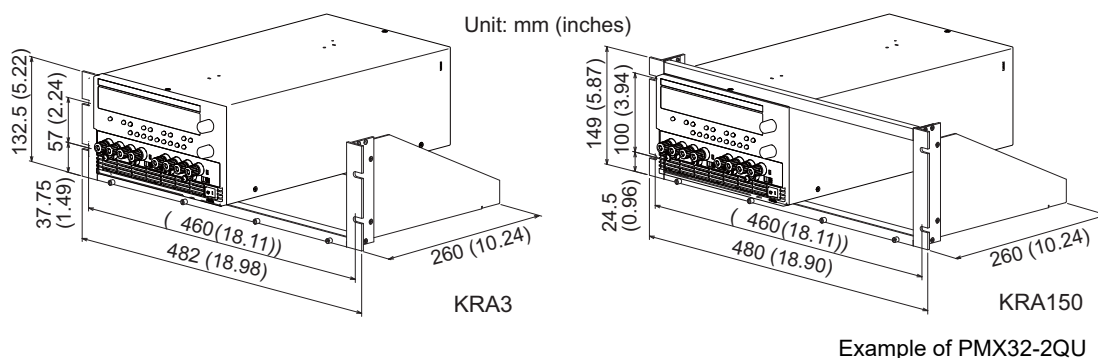

Remove the handle and feet before you mount the product to a rack.

For information on rack mounting, see the KRA3 or KRA150 operation manual.

Install the suitable support angles applying to the used rack system to support the instrument.

We recommend that you keep all pieces that you remove from the product. You will need these pieces if you remove the product from the rack mount adapter.

When you re-attach the original feet, use the pieces that you removed.

NOTE

To reinstall the handle that has been removed, use screw locking agent (e.g., 1401B by ThreeBond International, Inc.) to prevent screws from loosening.

Removing the handle and feet

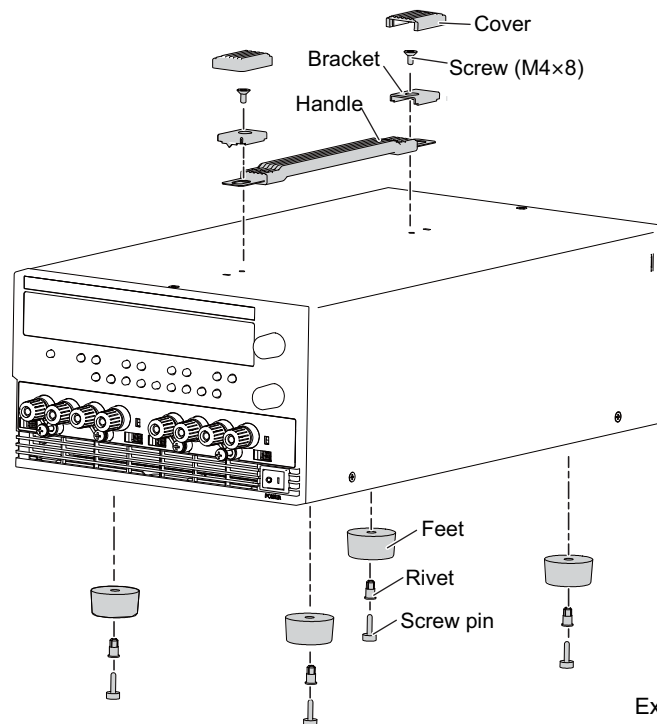

Example of PMX32-2QU

- 1** Remove the two handle covers.
- 2** Unfasten the two screws, and remove the entire handle.
- 3** While pulling down the rubber feet (four locations), loosen their screw pin with a screwdriver and remove the feet.

This completes the removal.

Troubleshooting

This section introduces troubleshooting measures. Typical symptoms are listed. Check whether any of the items listed below apply to your case. In some cases, the problem can be solved quite easily.

If none of the items apply to your case, we recommend that you initialize the product to its factory default settings (p.96). If following the remedy does not solve your problem, contact your Kikusui agent or distributor.

■ Nothing appears on the display when the POWER switch is turned on.

Check	Possible cause	Remedy	See
Is the rated voltage being applied to the input power supply (AC)?	The power cord is broken.	Check that the power cord is not broken.	p.13
	The power cord is not connected properly.	Check that the power is connected properly.	p.13
Is the product configured to use a DHCP server for the LAN interface?	A DHCP server environment is not available or is not in a good condition.	Configure the product to not use a DHCP server (CF41), or consult your network administrator.	p.50
Is the S1 switch on the rear panel in the correct position?	The switch has not been returned to the correct position after performing maintenance.	Set the S1 switch on the rear panel to the correct position.	p.12

■ No output is generated even when the output is turned on.

Check	Possible cause	Remedy	See
Is the output voltage set to 0 V and the output current set to 0 A?	The output voltage or output current has not been set.	Set the output voltage and output current to the required values.	p.28
Are you using an external contact to turn output on and off?	The external control settings for turning the output on and off are not correct.	To use external control, use the external contact to turn the output on. Otherwise, set the external control parameter for turning output on and off to off (CF04: □FF).	p.46
Is the overvoltage protection (OVP) function activated?	The OVP setting is lower than the voltage setting.	Set the OVP value higher than the voltage setting.	p.38
Is the overheat protection (OHP) function activated?	The internal temperature is abnormally high.	Check the operating conditions. After you have resolved the cause of the abnormal temperature, turn the output on.	p.41
	The air outlet is blocked.	Move the product so that there is at least 20 cm of space between the vents and the surrounding walls. Do not place objects within 20 cm of the vents.	-

■ The output is unstable

Check	Possible cause	Remedy	See
Is the operation mode switching from CV to CC or CC to CV?	The setting (output voltage or output current) that is limiting the output is less than the present setting.	Change the setting (output voltage or output current) that is limiting the output to a value greater than the present setting. If the setting is at maximum, you must use a power supply that has a larger output voltage or current.	p.34
Is the remote sensing function in use?	The remote sensing function is turned on.	When you are not using the remote sensing function, turn off the SENSE switch.	p.23
Are both "CV" and "CC" displayed?	Remote sensing is causing an oscillation.	Insert a capacitor across the load.	p.23
	The circuit may be malfunctioning.	Stop using the product immediately, and have it repaired.	—
Are the sensing cable and load cable conditions normal?	The sensing cables or load cables have poor contact, or they are broken.	Turn the POWER switch off, and check conditions of the cables and the wiring.	p.19 p.24
Does the load current have peaks, or is it pulse shaped?	The peak values may be exceeding the set constant current.	Increase the set constant current or increase the current capacity.	p.34
Has 30 minutes passed since the power was turned on?	The warm-up time (with the current running) may be insufficient.	Warm up the product (with the current running) for at least 30 minutes.	p.85

■ The output ripple is large

Check	Possible cause	Remedy	See
Do the ripples become large occasionally?	The input voltage is outside the range.	Apply a voltage that is within the input voltage range.	p.85
Did you change the installation location?	Something nearby may be generating a strong magnetic or electrical field.	Take measures such as moving the product away from the field sources or twisting the cables.	—
Is external control in use?	The external voltage noise is large.	Take measures against noise.	—
Was the load connection changed?	The remote sensing cables are not connected.	When you are not using remote sensing, disconnect the remote sensing cables.	p.24

■ “ALARM” is displayed when the output is turned on.

Check	Possible cause	Remedy	See
Is the overvoltage protection (OVP) function activated?	The OVP setting is lower than the voltage setting.	Set the OVP value higher than the voltage setting.	p.38
Is the overcurrent protection (OCP) function activated?	The OCP setting is lower than the current setting.	Set the OCP value higher than the current setting.	p.39
Is the remote sensing function in use?	The remote sensing function is turned on.	When you are not using the remote sensing function, turn off the SENSE switch.	p.23
	The voltage drop in the load cables is not within the compensation voltage range.	Set up the environment so that the voltage drop in each load cable is within the compensation voltage range (0.6 V for a single line).	p.16
	The polarities of the remote sensing cables are connected in reverse, or the ends of the cables are shorted.	Check the sensing cable connection.	p.19
Is external control in use?	The control cable is disconnected.	Connect the cable correctly.	p.61
	The external voltage is excessive.	Apply the correct voltage.	
Is the overheat protection (OHP) function activated?	The internal temperature is abnormally high.	Check the operating conditions. After you have resolved the cause of the abnormal temperature, turn the output on.	p.41
	The inlet holes are clogged, or the fan is broken.	Clean the inlet holes. Check that the fan is not broken.	–
Did you change the load?	A large external voltage, such as that of a battery load, is applied, and the overvoltage protection (OVP) is activated, or the product is overloaded.	Check the load.	–
	The actual output voltage higher than the set voltage that is displayed on the panel, and the product is overloaded.		–
	A special load is connected, and the product is overloaded.		–

■ Unable to perform panel operations

Check	Possible cause	Remedy	See
Is “LOCK” shown in the display area?	The keys are locked.	Release the key lock.	p.54
Is “REMOTE” shown in the display area?	The product is in remote control mode.	To control the product from the panel, press the LOCAL key to switch to local mode.	p.59
Is the product being controlled via the RS232C, USB, or LAN interface?			
Does the product fail to change to local mode even when the LOCAL key is pressed?	Remote with local lockout (RWL) has been set with a communication command.	Send a SYST:COMM:RLST command to clear remote with local lockout (RWL).	—

■ **Unable to perform remote control**

Check	Possible cause	Remedy	See
When the LAN interface is in use, is the IP address being assigned automatically?	Auto IP address assignment by a DHCP server cannot be finalized.	A timeout may have occurred while the PMX was waiting for a response from the DHCP server or because no response was received. Consult your network administrator.	p.50
	When the POWER switch is turned on, does the LAN interface display persist for more than 30 seconds?		
	Is "LAN" shown in orange or red in the display area?	If it is shown in orange, the product is waiting for a response from the DHCP server. If it changes to red afterward, the product may have timed out. Consult your network administrator.	p.50

■ **Memory recall fails.**

Check	Possible cause	Remedy	See
Is parallel operation or series operation in use?	The memory contents of CH1 and CH2 saved during normal operation cannot be recalled during series operation or parallel operation.	Return to normal mode, or save the settings to memory during series operation or parallel operation.	p.52

Index

A

alarm	
clearing	37
alarm occurrence	37
alarm signal	37

B

build number display	51
buzzer	48

C

CC mode	34, 36
communication monitoring timer	48
constant-current mode	34
constant-current power supply	34, 36
constant-voltage mode	34
constant-voltage power supply	34
CV mode	34

F

firmware version display	51
--------------------------------	----

I

IP address assignment	
AUTO IP	50
MANUAL IP	50
using DHCP server	50
IP address display	49
IP address prefix	50

K

key lock content	46
------------------------	----

L

LAN interface	47
applying settings	49
resetting	49

M

MAC address display	49
MANUAL IP setting	50
memory contents, display	45

O

OCP	39
OHP	41
output	
delay time	30
output on and off	

external control	46
output-on startup state	46
OVP	38

P

panel operation	26
power-on status	45
product ID display	51
protection function	
communication monitoring	41
overcurrent protection	39
overheat protection	41
overvoltage protection	38

R

rack mount adapter	97
rise time when a value is changed	46
RS232C baud rate	51
RS232C interface	48

S

SCPI communication error display	48
settings, reset	45

T

tracking function 1	
procedure	56
tracking function 2	
procedure	58

U

USB interface	47
---------------------	----

V

vendor ID display	51
-------------------------	----

W

WATCHDOG	41
----------------	----

If the manual gets lost or soiled, a new copy can be provided for a fee. In either case, please contact your Kikusui agent or distributor. At that time, inform your agent or distributor of the "Part No." written on the front cover of this manual.

Every effort has been made to ensure the accuracy of this manual. However, if you have any questions or find any errors or omissions, please contact your Kikusui agent or distributor.

After you have finished reading this manual, store it so that you can use it for reference at any time.

KIKUSUI ELECTRONICS CORP.

1-1-3 Higashiyamata, Tsuzuki-ku, Yokohama,
224-0023, Japan

Tel: +81-45-482-6353 Fax: +81-45-482-6261



Website

<http://www.kikusui.co.jp/en>