

# User's Manual

## Regulated DC Power Supply

PMX-A Series

**PMX18-2A**

**PMX18-5A**

**PMX35-1A**

**PMX35-3A**

**PMX70-1A**

**PMX110-0.6A**

**PMX250-0.25A**

**PMX350-0.2A**

**PMX500-0.1A**

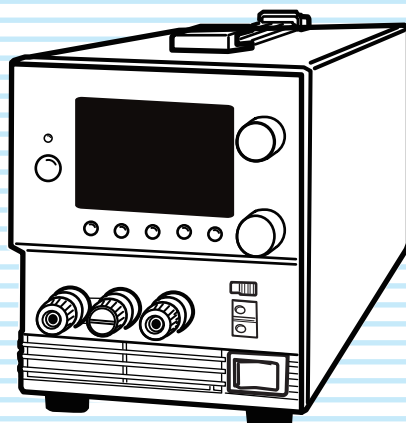

## About the PMX-A Manuals

These manuals are intended for users of the Regulated DC Power Supply and their instructors. It is assumed that the reader has knowledge about electrical aspects of regulated DC power supplies.

### Manual construction

#### ■ Safety information

This document contains general safety precautions for this product. Keep them in mind and make sure to observe them.

#### ■ User's manual (this manual, PDF)

This document is intended for first-time users of this product. It provides an overview of the product and notes on usage. It also explains how to configure the product, operate the product, perform maintenance on the product, specifications the product, and so on. To effectively use the product features, read this document from beginning to end. We recommend that you read it thoroughly before using this product for the first time.

If you forget how to use the product or if a problem occurs, we recommend that you refer to this document again.

#### ■ Quick reference

This document explains Panel description and operation briefly.

#### ■ Communication Interface Manual (HTML, PDF)

This document explains how to control the product remotely using commands.

The interface manual is written for readers with sufficient basic knowledge of how to control power supplies using a PC.

PDF and HTML files are included in the accompanying CD-ROM.

Adobe Reader is required to view the PDF files.

Microsoft Internet Explorer or Google Chrome is required to view the HTML files.

The newest version of the manual can be downloaded from Download service of Kikusui website.

If you find any misplaced or missing pages in the manuals, they will be replaced. If the manual gets lost or soiled, a new copy can be provided for a fee. In either case, please contact your Kikusui agent or distributor. At that time, inform your agent or distributor of the "Part No." written on the front cover of this manual.

Every effort has been made to ensure the accuracy of this manual. However, if you have any questions or find any errors or omissions, please contact your Kikusui agent or distributor.

After you have finished reading this manual, store it so that you can use it for reference at any time.

### Firmware versions that this manual covers

This manual covers IFC firmware versions 1.5X, IOC firmware versions 1.1X.

When contacting us about the product, please provide us with:

The model (marked in the top section of the front panel)

The firmware version (see page 11)

The serial number (marked on the rear panel)

### Trademarks

Microsoft, Windows, and Visual Basic are registered trademarks of Microsoft Corporation in the United States and/or other countries.

All company names and product names used in this manual are trademarks or registered trademarks of their respective companies.

### Copyrights

The contents of this guide may not be reproduced, in whole or in part, without the prior consent of the copyright holder.

The specifications of this product and the contents of this guide are subject to change without prior notice.

Copyright © 2013 Kikusui Electronics Corporation

## Product Overview

The PMX-A Series is a lineup of easy-to-use, compact regulated DC power supplies.

It can be controlled remotely through the standard-equipped communication feature.

Model	Maximum operating current	Maximum operating voltage	Power
PMX18-2A	2 A	18 V	36 W
PMX18-5A	5 A	18 V	90 W
PMX35-1A	1 A	35 V	35 W
PMX35-3A	3 A	35 V	105 W
PMX70-1A	1 A	70 V	70 W
PMX110-0.6A	0.6 A	110 V	66 W
PMX250-0.25A	0.25 A	250 V	62.5 W
PMX350-0.2A	0.2 A	350 V	70 W
PMX500-0.1A	0.1 A	500 V	50 W

## Features

### Communication feature

RS232C, USB, and LAN interfaces are all installed as standard.

The remote interfaces comply with IEEE Std 488.2-1992 and SCPI Specification 1999.0.

Because the LAN interface complies with the LXI standard, the construction of a highly cost-effective system is possible.

### Setting preset feature

You can save up to three sets of output settings (the combination of the voltage value and current value). You can simply select a set of output settings that you want to use rather than having to specify each setting every time.

### External control

External analog signals can be used to control the output voltage and current, turn the output on and off, and monitor the operation mode.

### Remote sensing (equipped on models whose rated output voltage is 18 V or 35 V)

Remote sensing stabilizes the output voltage across the load by reducing the influence of voltage drops and other effects caused by the load cable resistance.

### Standard protection functions

The PMX-A series is equipped with standard overvoltage protection (OVP), overcurrent protection (OCP), and over-heat protection (OHP) functions. When a protection function is activated, the cause of it is indicated on the front panel display area. The output is turned off to protect the product and the load.



## Safety Precautions

When using this product, be sure to observe the “Safety Precautions” in the Safety information manual.



## Precautions Concerning Installation Location

When installing this product, be sure to observe the “Precautions Concerning Installation Location” in the Safety information manual. The following precautions pertain only to this product.

- When installing this product, be sure to observe the temperature and humidity ranges indicated below.  
Operating temperature range: 0 °C to +40 °C (32 °F to 104 °F)  
Operating humidity range: 20 %rh to 85 %rh (no condensation)
- When storing this product, be sure to observe the temperature and humidity ranges indicated below.  
Storage temperature range: -25 °C to +70 °C (-13 °F to 158 °F)  
Storage humidity range: 90 %rh or less (no condensation)

## Notations Used in This Guide

- In this manual, the PMX-A Series Regulated DC Power Supply is referred to as the “PMX-A.”
- The term “PC” is used to refer generally to both personal computers and workstations.
- The screen captures used in this manual may differ from the actual screens that appear on the PMX-A series. The screen captures are merely examples.
- The following markings are used in the explanations in this manual.

### WARNING

Indicates a potentially hazardous situation which, if ignored, could result in death or serious injury.

### CAUTION

Indicates a potentially hazardous situation which, if ignored, may result in damage to the product or other property.

### NOTE

Indicates information that you should know.

### DESCRIPTION

Explanation of terminology or operation principle.

### See

Indicates a reference to detailed information.



Indicates a reference to a manual containing detailed information.

### CFxx:x

“CF” indicates that this is a CONFIG parameter. The two digits after CF indicate the CONFIG parameter number. The value after the colon indicates the selected setting.

### SHIFT+key name (blue letters)

Indicates an operation that requires you to press a key indicated in blue characters (below the key) while holding down the SHIFT key.

### Memo

Indicates useful information.

# Contents

About the PMX-A Manuals .....	2
Product Overview .....	3
Safety Precautions .....	3
Precautions Concerning Installation Location .....	3
Notations Used in This Guide .....	3
Search by Topic.....	5
Component Names.....	6

## 1 Preparation

Connecting the Power Cord.....	10
Turning the Power On.....	11
Turning the POWER switch on .....	11
Turning the POWER switch off .....	12
Load Considerations.....	13
Load Cables.....	16
Connecting to the Output Terminals.....	17
Sensing.....	18
Local sensing .....	18
Remote sensing (equipped only on models whose rated output voltage is 18 V or 35 V) .....	18

## 2 Basic Functions

Measured Value Display and Setting Display ..	22
Panel Operations .....	23
Output Operations .....	23
CC Power Supply and CV Power Supply ...	24
Using the PMX-A Series as a CV or CC Power Supply .....	26
Protection Functions and Alarms.....	27
Alarm occurrence and clearing alarms .....	27
Protection function activation.....	28
CONFIG Settings.....	31
CONFIG parameter details .....	35
Preset Memory Function.....	39
Saving settings to preset memory.....	39
Recalling preset memory entries .....	40
Locking Panel Controls (Key lock).....	41
Remote Control.....	41
Factory Default Settings (Initialization) .....	42

## 3 External Control

General Description .....	44
About the J1 Connector .....	44
Output Terminal Insulation.....	46

When the output terminal is not grounded (floating) .....	46
When the output terminal is grounded .....	47
Cautions when using the external voltage (Vext).....	48
Output Voltage Control .....	49
Control using an external voltage (Vext)...	49
Control using an external resistance (Rext) .....	50
Output Current Control.....	51
Control using an external voltage (Vext)...	51
Control using an external resistance (Rext) .....	52
Controlling the Output On and Off States ..	53
External Monitoring .....	55

## 4 Parallel/Series Operation

Parallel Operation .....	58
Parallel operation features .....	58
Parallel operation connection.....	59
Parallel operation settings.....	60
Starting parallel operation .....	60
Series Operation .....	61
Series operation features .....	61
Series operation connection.....	62
Series operation settings.....	63
Starting series operation .....	63

## 5 Maintenance

Calibration.....	66
Calibration overview.....	66
Calibration procedure.....	67

## 6 Specifications

PMX18-2A/ PMX18-5A/ PMX35-1A/ PMX35-3A.....	72
PMX70-1A/ PMX110-0.6A/ PMX250-0.25A/ PMX350-0.2A/ PMX500-0.1A ..	78

## Appendix

A Options .....	86
B Troubleshooting.....	88

# Search by Topic

## Preparation

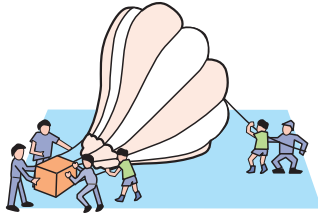

- I want to check the accessories. → See the included packing list. —
- The installation space is limited, so I want to check the installation conditions. → See the included "Safety information" document, or the electronic version of the document on the CD-ROM. —
- How do I connect the AC power supply? → "Connecting the Power Cord" p.10
- What kind of load cables should I use? → "Load Cables" p.16
- How do I ensure stable voltage when the cables connected to the load are long (the distance to the load is long)? → "Sensing" p.18
- How do I rack mount the PMX-A series? What kind of parts are needed? → "Rack mount option" p.86

## Setup



- How do I use remote sensing to stabilize the PMX-A series? → "Sensing" p.18
- How do I set the protection functions to prevent damage to the load? → "Protection Functions and Alarms" p.27
- After a protection function has been activated, how do I restart tests automatically when the cause of the alarm is fixed? → "Alarm occurrence and clearing alarms" p.27
- How do I set the communication conditions for remote control? → See the Communication Interface Manual on the included CD-ROM. —
- How do I check the settings in preset memory? → "Recalling preset memory entries" p.40
- How do I reset the PMX-A series to its factory default settings? → "Factory Default Settings (Initialization)" p.42

## Operation

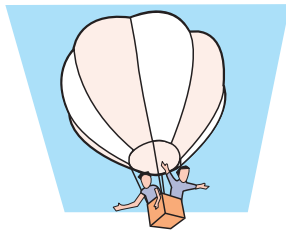

- How do I use the PMX-A series as a constant voltage power supply (CV mode)? → "Using the PMX-A Series as a CV or CC Power Supply" p.26
- How do I use the PMX-A series as a constant current power supply (CC mode)? —
- How do I operate the PMX-A series at a specific current? How do I save current values to the preset memory? → "Preset Memory Function" p.39
- How do I control the output voltage with an external DC voltage? → "Output Voltage Control" p.49
- How do I monitor the output voltage and output current? → "External Monitoring" p.55
- How do I prevent the settings from being changed? → "Locking Panel Controls (Key lock)" p.41

## Maintenance



- How do I clean the PMX-A series? → See the included "Safety information" document, or the electronic version of the document on the CD-ROM. —
- How do I calibrate the PMX-A series? → "Calibration" p.66

## Troubleshooting

See "Troubleshooting" on page 88.

# Component Names

## Front Panel

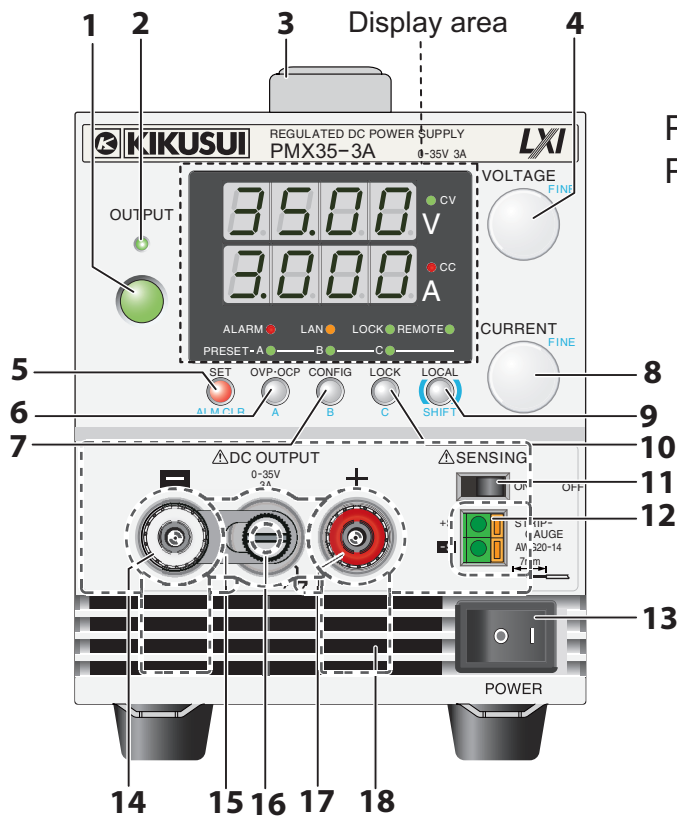

PMX18-2A, PMX18-5A,  
PMX35-1A, PMX35-3A

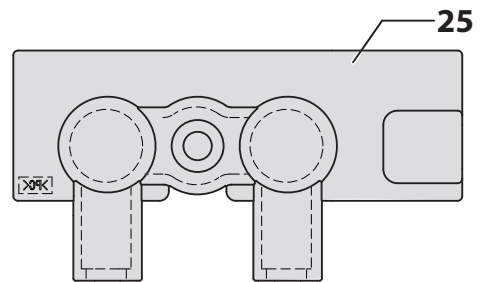

### Display area (Common)

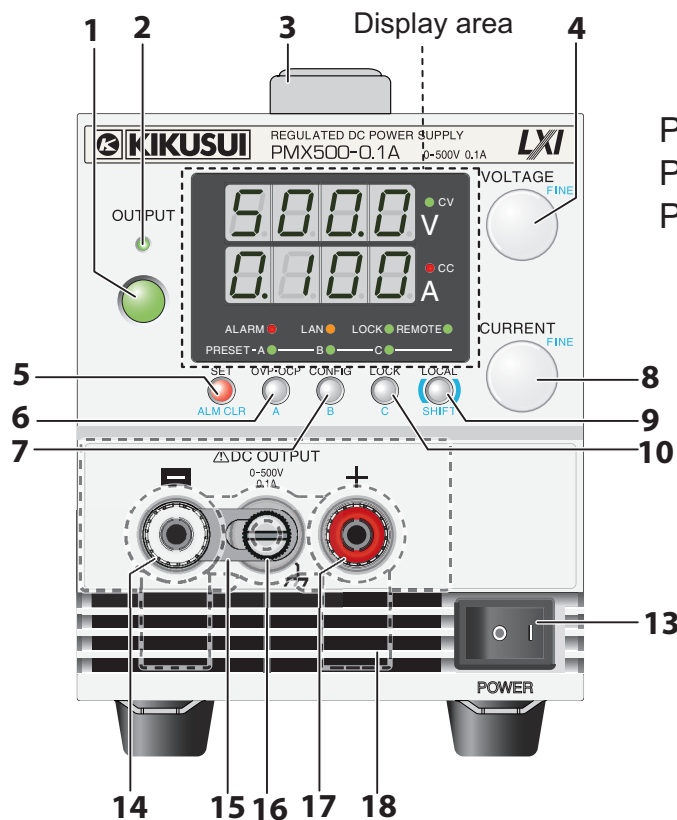
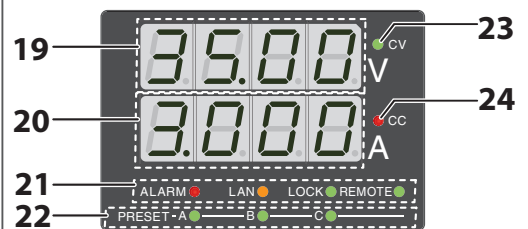

PMX70-1A, PMX110-0.6A,  
PMX250-0.25A, PMX350-0.2A,  
PMX500-0.1A

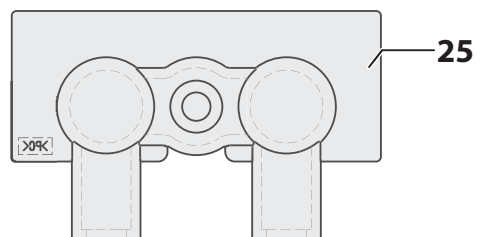



No.	Name	Function	See
1	OUTPUT key	Used to turn output on and off.	p.23
2	OUTPUT LED	Lights when the output is on (green).	p.23
3	Handle	Handle for carrying.	—
4	VOLTAGE knob	Used to set the voltage value or change the value of a CONFIG parameter.	p.23, p.32
	FINE	Used to make fine voltage value adjustments.	p.23
5	SET key	Used to set and confirm the output voltage and output current (the key has an LED).	p.22
	ALM CLR key	Used to release protection functions that have been activated (the key has an LED).	p.27
6	OVP•OCP key	Used to set and display the overvoltage protection (OVP) and overcurrent protection (OCP) trip points (the key has an LED).	p.28
	A	Used to recall and save the value of preset memory A (the key has an LED).	p.39
7	CONFIG key	Used to configure the various operating conditions (the key has an LED).	p.31
	B	Used to recall and save the value of preset memory B (the key has an LED).	p.39
8	CURRENT knob	Used to set the current value or change the value of a CONFIG parameter.	p.23, p.31
	FINE	Used to make fine current value adjustments.	p.23
9	LOCAL key	Used to switch between local mode and remote mode.	p.41
	SHIFT key	Used to enable the functions that are written in blue characters below the key.	—
10	LOCK key	Used to lock the operation of panel keys, rotary knob, etc.	p.41
	C	Used to recall and save the value of preset memory C.	p.39
11	Sensing switch <sup>1</sup>	Used to turn remote sensing on and off.	p.19
12	Sensing terminal <sup>1</sup>	Terminals to connect the sensing cables to.	p.19
13	POWER switch	Flip the switch to the ( I ) side to turn the power on. Flip it to the ( O ) side to turn the power off.	p.11
14	DC OUTPUT – (negative)	Output terminal.	p.17
15	Short bar	A bar that connects the output terminal to the chassis terminal.	p.59, p.62
16	Chassis terminal	A connector for grounding the output.	—
17	DC OUTPUT + (positive)	Output terminal.	p.17
18	Air inlet	Air inlet for cooling the inside of the PMX-A series.	—
19	Voltmeter	Displays the voltage, CONFIG parameter number, or alarm.	p.22, p.27,
20	Ammeter	Displays the current, the value of a CONFIG parameter, or the cause of an alarm.	p.31
21	Status LEDs	ALARM: Lights in red when a protection function has been activated. LAN: Lights and blinks when the LAN interface is in use. •No fault status: Lights in green. •Fault status: Lights in red. •Standby status: Lights in orange. •WEB identify status: Blinks green.	—
		LOCK: Lights in green when the keys are locked. REMOTE: Lights in green during remote control.	
22	PRESET LED	A: Lights in green when the memory A values are being recalled or saved. B: Lights in green when the memory B values are being recalled or saved. C: Lights in green when the memory C values are being recalled or saved.	p.39
23	CV LED	Lights in green during constant voltage mode.	p.26
24	CC LED	Lights in red during constant current mode.	p.26
25	OUTPUT terminal cover <sup>2</sup>	Protection cover	p.17

1 The remote sensing function is not available on models with rated output voltage of 70 V or higher.

2 With an output terminal cover at factory shipment.

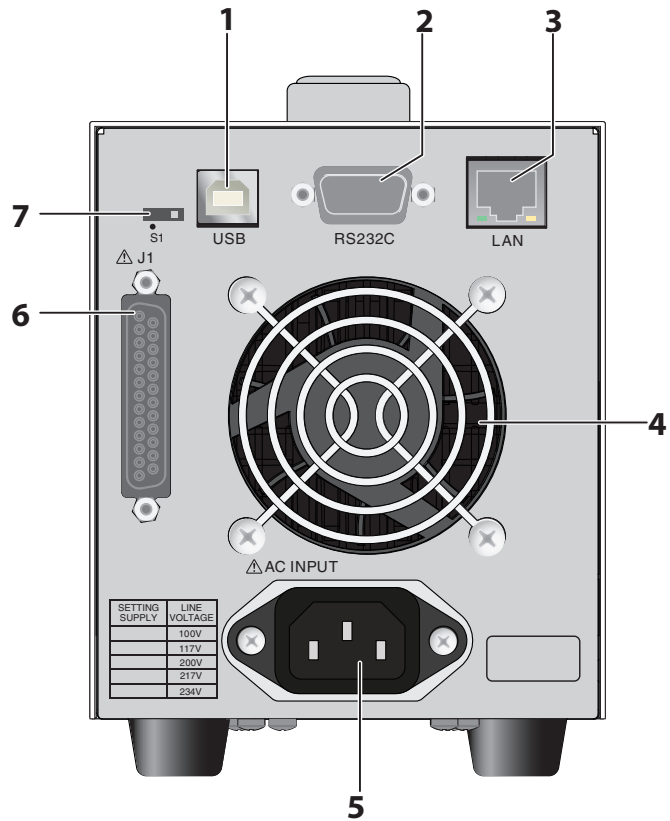
## Rear Panel



No.	Name	Function	See
1	USB	USB port for controlling the PMX-A series remotely.	
2	RS232C	RS232C port for controlling the PMX-A series remotely.	
3	LAN	Ethernet port for controlling the PMX-A series remotely.	 Interface manual
4	Air outlet	Air outlet for cooling the inside of the PMX-A series.	—
5	AC INPUT	AC inlet.	p.10
6	J1	External control connector.	p.44
7	S1	Maintenance switch. <sup>1</sup>	—

1 Kikusui service engineers use this switch only during maintenance and servicing. Normally, the LED is off when the switch is on the opposite side of ●.





# 1

---

## Preparation

This chapter describes how to turn on the PMX-A series, what kind of load cables to use, and how to connect cables to the output connectors.

For information about installing and moving this product, see “Precautions Concerning Installation Location” and “Precautions to Be Taken When Moving the Product” in the Safety information manual.

When using or storing this product, be sure to observe the temperature and humidity ranges. For environmental conditions, see “General specifications” (p.77, p.83).

If you want to mount the product on a rack, see “Rack mount option” (p.86).

# Connecting the Power Cord

This product conforms to IEC Overvoltage Category II (energy-consuming equipment that is supplied from a fixed installation).



**WARNING**

## Risk of electric shock.

- This product conforms to IEC Safety Class I (equipment that has a protective conductor terminal). Be sure to earth ground the product to prevent electric shock.
- The product is grounded through the power cord ground wire. Connect the protective conductor terminal to earth ground.



- Use the supplied power cord to connect to the AC line. If the supplied power cord cannot be used because the rated voltage or the plug shape is incompatible, have a qualified engineer replace it with an appropriate power cord that is 3 m or less in length. If obtaining a power cord is difficult, contact your Kikusui agent or distributor.
- The power cord with a plug can be used to disconnect the PMX-A series from the AC power line in an emergency. Connect the plug to an easily accessible power outlet so that the plug can be removed from the outlet at any time. Be sure to provide adequate clearance around the power outlet.
- Do not use the supplied power cord with other instruments.

## 1 Check that the AC power line meets the nominal input rating of the product.

The nominal input rating of this product is indicated on the rear panel. The product accepts 50 Hz or 60 Hz.

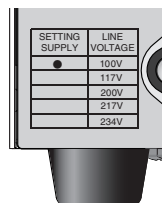

The supply voltage is set before factory shipment by a Kikusui service engineer. If the voltage is set to another setting, a mark will be indicated to the left of the appropriate voltage.

Be sure to check the nominal input rating before connecting the power cord.

The example of supply voltage 100 Vac

## 2 Check that the POWER switch is turned off.

## 3 Connect the power cord to the AC inlet on the rear panel.

## 4 Insert the power plug into a grounded outlet.

# Turning the Power On

## Turning the POWER switch on

**CAUTION**

You can use the CONFIG settings to set how the PMX-A series starts when you turn the POWER switch on. Depending on the setting, the output may be turned on automatically when the POWER switch is turned on. If you connect a load without setting OVP and OCP to the appropriate values, the load may be damaged if output automatically turns on when the power is turned on.

See p.42

When you turn the POWER switch on for the first time after purchase, the PMX-A series starts with its factory default settings. Subsequent times that you turn the PMX-A series on, it starts with the panel settings (excluding the output on/off setting) that were in use immediately before the POWER switch was turned off.

See p.35

You can use the CONFIG settings (CF01) to select the output state of the PMX-A series when the POWER switch is turned on.

### 1 Check that the power cord is connected correctly.

### 2 Turn the POWER switch on (I).

All the LEDs light, and then the voltmeter and the ammeter display the following sequence of information: the rated voltage and rated current, the IOC firmware version, the IFC firmware version, and then the selected interface. Each item is displayed for approximately 1 second. Two firmware versions, IOC and IFC, are displayed.

After a few seconds, the PMX-A series enters the operation standby state (the output value is displayed).



Rated voltage and rated current display (PMX18-5A in this example)



IOC firmware version display (Version 1.10 in this example)



IFC firmware version display (Version 1.00 in this example)



Interface display (The LAN interface is selected in this example.)

See p.88, p.90

If you select the LAN interface and the interface display remains showing (for approximately 30 seconds) when the POWER switch is turned on, the PMX-A series is waiting for a response from the DHCP server.

### Inrush current

See p.72, p.78

When the POWER switch is turned on, an inrush current flows. Check that sufficient current capacity is available in the AC power line or the switchboard, particularly if you are using multiple PMX-As and turning on their POWER switches simultaneously.

For the inrush current of each model, "Specifications".

## Turning the POWER switch off

---

Flip the POWER switch to the ( O ) side to turn the PMX-A series off.

The PMX-A series saves the panel settings (except the output on/off setting) that were in use immediately before the POWER switch was turned off.

 p.35

You can use the CONFIG settings (CF01) to select how the PMX-A series starts when the POWER switch is turned on.

If the POWER switch is turned off immediately after the settings have been changed, the last settings may not be stored.

---

 **CAUTION**

After you turn the POWER switch off, wait at least 10 seconds after the panel display turns off before you turn the POWER switch back on. Repeatedly turning the POWER switch on and off at short intervals can cause damage to the inrush current limiter. Furthermore, this will shorten the service life of the POWER switch and the internal input fuse.

---

# Load Considerations

Note that the output will become unstable if the following types of loads are connected.

## Loads with peak current or pulse-shaped current

The PMX-A series only indicates mean values. Even when the indicated value is less than or equal to the set constant current, the peak values may exceed the set constant current. If this happens, the PMX-A series is instantaneously put into constant-current mode, and the output voltage drops.

For these types of loads, you must increase the set constant current or increase the current capacity.

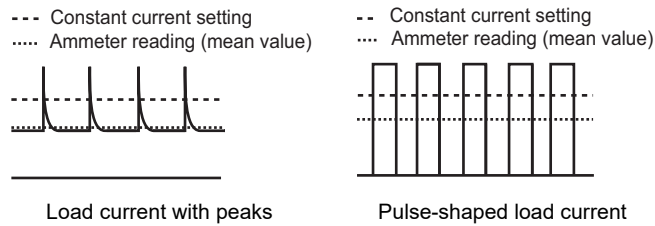

## Loads that generate reverse current to the power supply

The PMX-A series cannot absorb reverse current from the load. Therefore, if a regenerative load (such as an inverter, converter, or transformer) is connected, the output voltage increases and becomes unstable. This can cause a malfunction.

For these types of loads, connect a resistor ( $R_D$ ) as shown in the following figure to bypass the reverse current. However, the amount of current to the load decreases by  $I_{rp}$ .

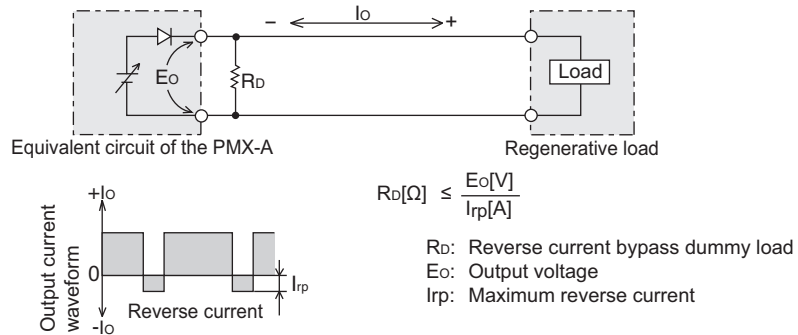

**CAUTION**

Use a resistor with sufficient rated power for  $R_D$ . If a resistor with insufficient rated power for the circuit is used, resistor  $R_D$  will burn out.

### Loads with accumulated energy

Connecting a load with accumulated energy, such as a battery, to the PMX-A series may cause current to flow from the load to the internal circuit of the PMX-A series. This current may damage the PMX-A series or reduce the life of the load.

For this type of load, connect a reverse-current-prevention diode (DRP) between the PMX-A series and the load in series as shown in the following figure.

This cannot be used in conjunction with remote sensing.

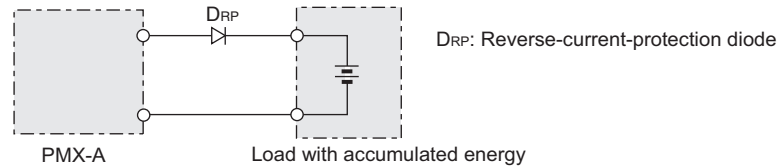

- 
- ⚠ CAUTION**
- To protect the load and the PMX-A series, use a DRP that conforms to the following specifications.  
Reverse voltage withstand capacity: At least twice the rated output voltage of the PMX-A series.  
Forward current capacity: 3 to 10 times the rated output current of the PMX-A series.  
A diode with small loss.
  - Be sure to take into account the heat generated by DRP. DRP will burn out with inadequate heat dissipation.
-

## Sink current from an external voltage source

Directly connecting an external voltage source to the PMX-A series may cause sink current to flow from the internal breeder circuit of the PMX-A series. This current may damage the PMX-A series or reduce the life of the load.

For this type of sink current, you need to connect a diode to the load cable or mechanically separate the load cable from the PMX-A series with a switch or the like.

Depending on the power-off or output-off state, the sink current that flows when an external voltage source is connected will vary.

The sink current is reduced at a low output terminal voltage. Hardly any sink current flows near 0 V. The sink currents indicated here are standard values.

### ■ Sink current from an external voltage source when the power is off or the output is off

Vout = Output terminal voltage

Model	State	Unit	Sink current					
			1 Vout	2 Vout	5 Vout	10 Vout	15 Vout	18 Vout
PMX18-2A	POWER off	mA	4.2	8.6	21.9	44.1	66.4	79.8
PMX18-5A	Output off		4.2	8.3	20.6	41.2	61.8	74.2

Vout = Output terminal voltage

Model	State	Unit	Sink current							
			2 Vout	5 Vout	10 Vout	15 Vout	20 Vout	25 Vout	30 Vout	35 Vout
PMX35-1A	POWER off	mA	6.3	16.2	32.7	49.2	65.7	82.3	99.2	119.0
PMX35-3A	Output off		6.0	15.0	30.0	45.0	60.0	75.0	90.0	106.0

Vout = Output terminal voltage

Model	State	Unit	Sink current							
			5 Vout	10 Vout	20 Vout	30 Vout	40 Vout	50 Vout	60 Vout	70 Vout
PMX70-1A	POWER off	mA	1.0	2.1	4.2	6.4	8.5	10.6	12.8	14.9
	Output off		37.0	39.0	41.0	43.0	45.0	48.0	50.0	53.0

Vout = Output terminal voltage

Model	State	Unit	Sink current							
			5 Vout	10 Vout	20 Vout	30 Vout	40 Vout	50 Vout	100 Vout	110 Vout
PMX 110-0.6A	POWER off	mA	1.1	2.1	4.1	6.1	8.2	10.2	20.4	22.4
	Output off		1.1	2.1	4.1	6.1	8.2	10.2	20.4	22.4

Vout = Output terminal voltage

Model	State	Unit	Sink current							
			10 Vout	20 Vout	30 Vout	50 Vout	100 Vout	150 Vout	200 Vout	250 Vout
PMX 250-0.25A	POWER off	mA	0.45	0.92	1.4	2.3	4.6	7.0	9.3	11.6
	Output off		0.45	0.92	1.4	2.3	4.6	7.0	9.3	11.6

Vout = Output terminal voltage

Model	State	Unit	Sink current							
			10 Vout	20 Vout	50 Vout	100 Vout	200 Vout	250 Vout	300 Vout	350 Vout
PMX 350-0.2A	POWER off	mA	0.16	0.32	0.8	1.6	3.2	4.0	4.8	5.6
	Output off		23.0	24.0	25.0	28.0	35.0	38.0	40.0	43.0

Vout = Output terminal voltage

Model	State	Unit	Sink current						
			20 Vout	50 Vout	100 Vout	200 Vout	300 Vout	400 Vout	500 Vout
PMX 500-0.1A	POWER off	mA	0.23	0.57	1.2	2.3	3.5	4.6	5.8
	Output off		9.0	9.0	10.0	11.0	12.0	13.0	14.0

# Load Cables



## **WARNING** Risk of fire.

- Use load cables whose capacity is adequate for the PMX-A series' rated output current.
- The output connector and its surrounding area become very hot. Use cables whose covers have heat resistance at 85 °C and higher.

## Risk of electric shock.

- Use load cables with a voltage rating that meets or exceeds the PMX-A series' isolation voltage. For the PMX-A series' isolation voltage, "Specifications" on page 71.

## ■ The cables' allowable current depends on the insulation's maximum allowable temperature.

A cable's temperature is determined by the resistive loss based on the current, the ambient temperature, and the cable's external thermal resistance. The following table shows the current capacity of heat-resistant vinyl wires that have a maximum allowable temperature of 60 °C when one of the wires is separated and stretched out horizontally in air in an ambient temperature of 30 °C. The current capacity must be reduced under certain conditions, such as when vinyl cables that have a low heat resistance are used, when the ambient temperature is 30 °C or greater, or when cables are bundled together and little heat is radiated.

Nominal cross-sectional area (mm <sup>2</sup> )	AWG (reference cross-sectional area; mm <sup>2</sup> )	Allowable current <sup>1</sup> (A) (Ta = 30 °C)	Kikusui-recommended current (A)
0.9	18 (0.82)	17	4
1.25	16 (1.31)	19	6
2	14 (2.08)	27	10
3.5	12 (3.31)	37	-
5.5	10 (5.26)	49	20

1 Excerpt from Japanese laws related to electrical equipment.

## ■ Taking measures against noise

When connecting cables that have the same heat resistance, separating the cables as much as possible to increase heat radiation enables a greater amount of current to flow. However, wiring the + (positive) and - (negative) output wires of the load cable side by side or bundling them together is more effective against unwanted noise. The Kikusui-recommended currents shown in the above table are allowable currents that have been reduced in consideration of the potential bundling of load cables. Use these values as a guideline when connecting cables.

## ■ Limitations of the remote sensing

All wires have resistance. As the wire becomes longer or the current becomes larger, the voltage drop in the wire becomes greater. This results in a smaller voltage being applied at the load end. The PMX-A series has a sensing function that compensates for this voltage drop up to approximately 0.6 V for a single line (equipped only on models with a rated output voltage of 18 V or 35 V.) If the voltage drop exceeds this level, use wires that have a greater cross-sectional area.



# Connecting to the Output Terminals

When the PMX-A series is shipped from the factory, covers are attached to the output terminals. If they are damaged or lost, contact your Kikusui agent or distributor.

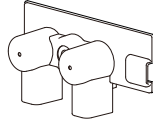

Models with a rated output voltage of 18 V or 35 V

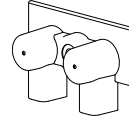

Models with a rated output voltage is 70 V or higher



## WARNING Risk of electric shock.

- Turn the **POWER** switch off before you touch the **OUTPUT** terminals.
- Do not use them with the terminal cover removed.
- Regardless of whether load cables are connected to the output terminals, be sure to attach the output terminal cover before turning the **POWER** switch on.

- 1 Turn the **POWER** switch off.
- 2 Attach crimping terminals to the load cables.
- 3 Remove the output terminal cover and Knobs, and attach the load cables to the output terminals.  
Connect the short bar to the negative or positive output terminal.  
If you are not grounding the output terminals (leaving them floating), refer to “Output Terminal Insulation” on page 46 before use.  
To reduce the influence of noise on the output, keep the wires as short as possible. If possible, twist the positive and negative load wires.
- 4 Attach the output terminal cover and Knobs.

The example of models whose rated output voltage is 18 V or 35 V

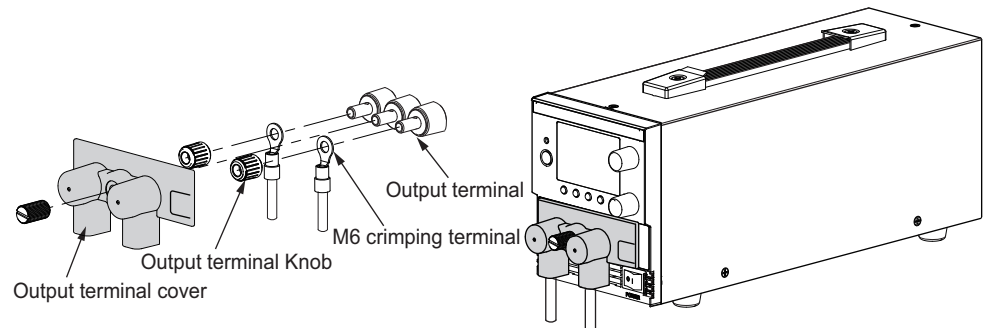

# Sensing

The PMX-A series is equipped with two sensing functions: local sensing and remote sensing. By factory default, the PMX-A series is set to local sensing (the sensing switch is set to off).

## Local sensing

Use local sensing when the cable to the load is short.

Local sensing does not compensate for the voltage drop in the load cable, so use this method when the load current is small or when you do not need to consider the load regulation voltage.

The sensing point during local sensing is the output terminal.

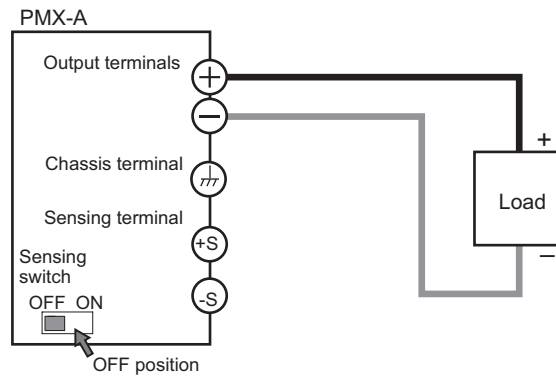

## Remote sensing (equipped only on models whose rated output voltage is 18 V or 35 V)

See p.16

Use remote sensing when the cable to the load is long.

Remote sensing stabilizes the output voltage across the load by reducing the influence of voltage drops and other effects caused by the load cable resistance.

You can use the PMX-A series' remote sensing feature to compensate up to 0.6 V for a single line. Select a load cable that has sufficient current capacity to prevent the voltage drop in the load cable from exceeding the compensation voltage.

When you perform remote sensing, set the voltage of the sensing point (across the load) so that it does not exceed the rated output voltage. If you are performing remote sensing with the voltage close to the maximum output voltage, the output is limited by the maximum output voltage (105 % of the rated output voltage). Electrolytic capacitors may be required at the sensing point (across the load).

To reduce the effect of noise, use twisted-pair wires or 2-core shielded wires. When you use shielded wires, connect the shield to the ground of the PMX-A series or the load.

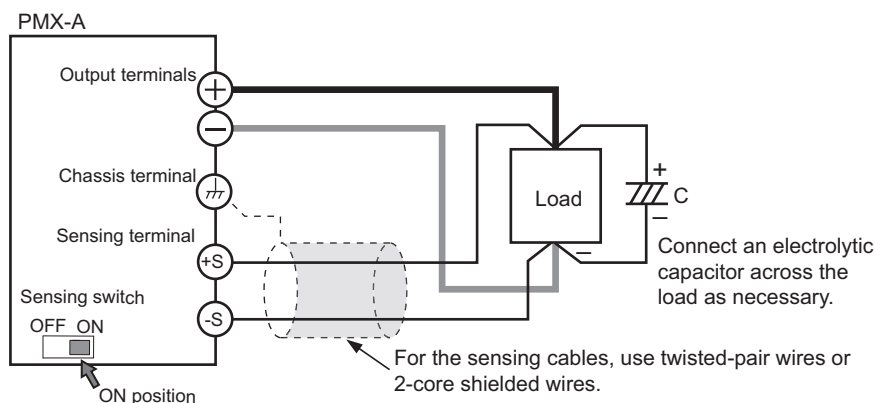

## Connecting the sensing cables



**WARNING** Risk of electric shock and damage to internal circuits.

- **Never wire the sensing terminals while the POWER switch is turned on.**
- **Use sensing cables with a voltage rating that is higher than the PMX-A series' isolation voltage. Protect the uncovered sections of the shielded cable by using insulation tubes whose withstand voltage is greater than the PMX-A series' isolation voltage.**
- **The sensing terminals are at approximately the same electric potential as the negative output terminal. Insert the cables so that the wire strands do not touch the chassis when they stick out of the sensing terminal. Also, insert the cables so that the stripped wires do not stick out of the terminal.**

If the sensing cables come loose, the output voltage across the load may become unstable, and an excessive voltage may be applied to the load. If an appropriate OVP trip point is set, the OVP will trip before an excessive voltage is generated.

If you are not going to use remote sensing, return the PMX-A series to local sensing mode.

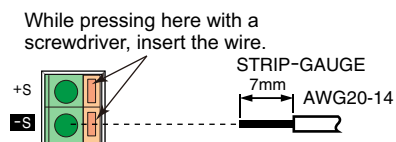
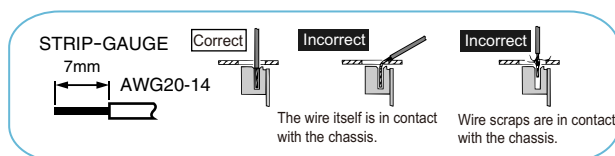
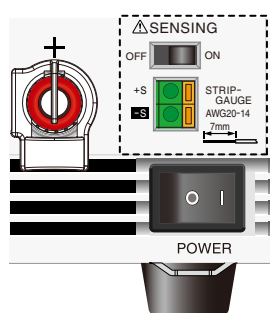

- 1 Turn the **POWER** switch off.
- 2 Remove the output terminal cover, and turn on sensing switch on the front panel.
- 3 Remove 7 mm of the wire covering. Connect the negative sensing cable to **-S** and the positive sensing cable to **+S**.

See p.17

#### 4 Pull out the sensing wires horizontally from the side of the output terminal cover, and attach the output terminal cover.

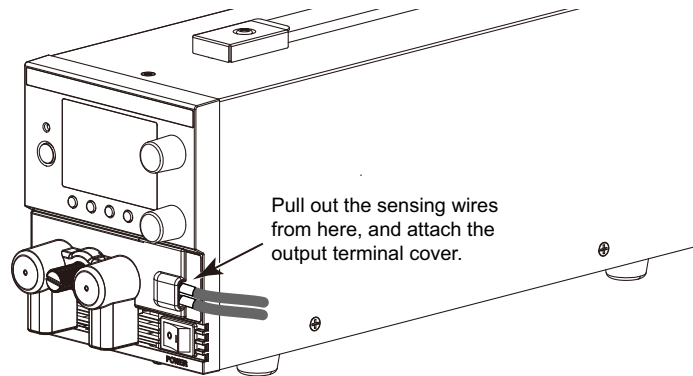

#### 5 Turn the POWER switch on.

If the wiring inductance component is large, the following symptoms may appear.

- The PMX-A series oscillates  
If the wires used to connect to the load are long, the wiring inductance and capacitance can cause phase shifting at a level that can not be ignored. This may lead to oscillation.
- The output fluctuates  
If the load current changes drastically in a pulse-shaped pattern, the output voltage may become large due to the wiring's inductance component.

You can reduce the inductance component by twisting the load cables, which stabilizes the voltage. However, if this does not correct the problem, connect an electrolytic capacitor across the load.

- Electrolytic capacitor to connect across the load  
Capacitance: 0.1  $\mu\text{F}$  to a few hundred  $\mu\text{F}$   
Withstand voltage: At least 120 % of the rated output voltage of the PMX-A series

#### ■ If you are inserting a mechanical switch between the PMX-A series and the load

If you want to connect and disconnect the load using a mechanical switch that is inserted between the PMX-A series and the load, be sure to include switches in the sensing cables as shown in the following figure and turn on and off the load cable and the sensing cables simultaneously. Before you turn the mechanical switch on or off, be sure to turn the output or the POWER switch off.

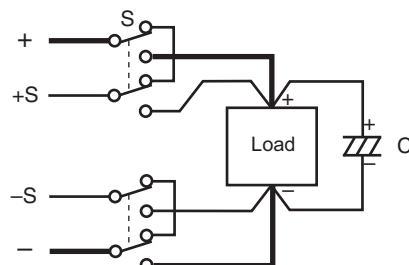



# 2

---

## Basic Functions

This chapter describes how to turn the output on and off and the basic operations that you can perform from the front panel.

# Measured Value Display and Setting Display

The voltage and current displays have the following two states.

- Measured value display
- Setting display

In addition to the voltmeter and ammeter, the PMX-A series can display the set OVP or OCP, and the system configuration.

## Measured value display

See p.26

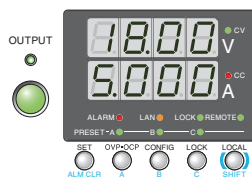

The present output voltage and output current are displayed. In this situation, the SET key is off. You can change the output voltage and output current in the measured value display.

## Setting display

See p.49, p.51

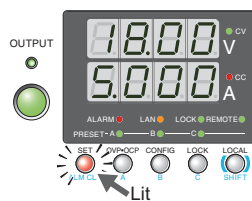

Press SET to light its LED and display the present set output voltage and output current settings.

Press SET again to return to the measured value display.

When you recall a preset memory entry, the values stored in the preset memory entry are displayed on the panel.

The display is different when the PMX-A series is being controlled externally.

During external voltage control, the voltmeter displays  $\square\square\square\square$ . During external current control, the ammeter displays  $\square\square\square\square$ .

## ■ Overvoltage protection and overcurrent protection setting display

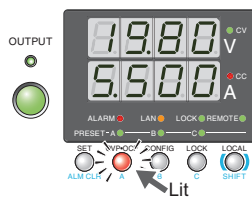

Press OCP•OVP to light its LED and display the present overcurrent protection and overvoltage protection settings.

## ■ System configuration setting display

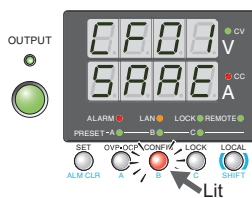

Press CONFIG to light its LED and display the current system configuration settings.

# Panel Operations

## Measured value display, setting display, and set OVP/OCP display

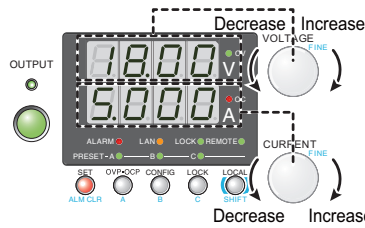

Turn the VOLTAGE knob to change the voltage. Turn the CURRENT knob to change the current.

You can set these values while output is on or off.

Press SET to switch to the setting display, and then change the output while you view the actual voltage or current settings.

### ★ Memo

When you set a value, it is convenient to first use normal resolution to set the value roughly and then switch to fine resolution to set it precisely.

### ■ Fine adjustment

You can change the resolution of the VOLTAGE and CURRENT knobs. Hold down SHIFT while you turn the VOLTAGE knob or CURRENT knob to make small changes to the value.

When the output is on, the displayed current or voltage may not change even if you turn the VOLTAGE or CURRENT knob. In this situation, the values are being changed at a finer resolution than that which is being displayed. The display will change when the amount that you change the value by reaches the smallest display digit of the set voltage or current.

The amount of change varies depending on whether the output is on or off.

When the output is on <sup>1</sup>	Changes are made at 1/10th the resolution of the minimum digit on the voltmeter or ammeter.
When the output is off	Changes are made at increments of 1 in the minimum digit on the voltmeter or ammeter.

<sup>1</sup> Note that, because smaller digits that are not displayed are also set, the actual setting may be different from the displayed value.

# Output Operations

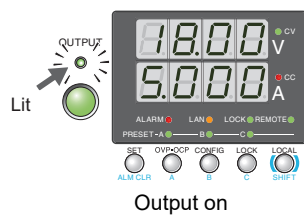

The output turns on and off each time that you press OUTPUT. When output is on, the OUTPUT LED lights. When the output is off, the OUTPUT LED turns off.

When the output is on, output is generated at the currently set values. If you change the settings while the output is on, the changes are applied to the output.

See p.36, p.53

You can use external control to turn the output on and off.

## Output on or off when the PMX-A series turns on

See p.42

By factory default, the output is off when the PMX-A series turns on. Using a CONFIG parameter (CF01: Forc), you can set the PMX-A series so that output is turned on at power-on.

See p.28

If you set the PMX-A series so that output is turned on at power-on, be sure to check the OVP trip point setting before you turn the PMX-A series off.

### ⚠ CAUTION

If you change the load, it may be damaged if the PMX-A series' OVP and OCP settings are not correct.

# CC Power Supply and CC Power Supply

The PMX-A series has features that makes it possible to function as a constant-voltage source and constant-current source even when the load is changed. The constant-voltage source operation is referred to as constant-voltage (CV) mode. The constant-current source operation is referred to as constant-current (CC) mode. The operation mode is determined by the following three values.

- Output voltage setting ( $V_s$ )
- Output current setting ( $I_s$ )
- Load resistance ( $R_L$ )

The operation modes are described below.

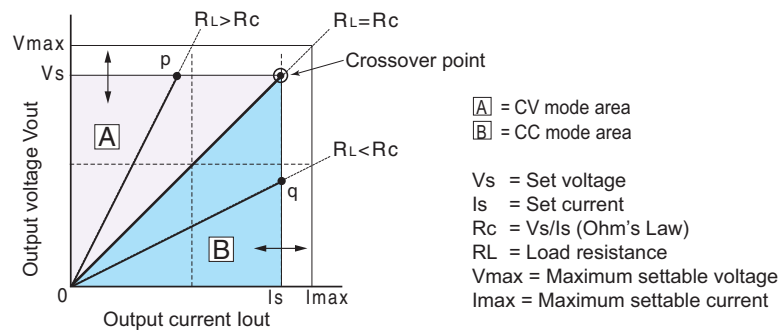

The above figure shows the PMX-A series operation modes. The load resistance is denoted as  $R_L$ . The resistance, which is denoted as  $R_c$ , is calculated from the set voltage and current ( $R_c = V_s/I_s$ ). The power supply is designed so that it operates in CV mode in area **A** and CC mode in area **B**. The boundary is the line defined by  $R_L = R_c$ . This line represents the load at which the output voltage and the set voltage are equal and the output current and the set current are equal. If load resistance  $R_L$  is greater than resistance  $R_c$ , the operating point is in area **A**, and the PMX-A series operates in CV mode (point p). In this case, the set current  $I_s$  equals the current limit.

When the PMX-A series is operating in CV mode, the output voltage is maintained at the set voltage. Output current  $I$  is determined by the equation  $I = V_s/R_L$  and is a current that is less than current limit  $I_s$ . The actual current that flows is not necessarily equal to the specified value.

For loads in which transient peak current flows, current limit  $I_s$  must be set higher than the peak value.

Conversely, if load resistance  $R_L$  is less than resistance  $R_c$ , the operating point is in area **B**, and the PMX-A series operates in CC mode (point q). In this case, set voltage  $V_s$  equals the voltage limit.

When the PMX-A series is operating in CC mode, the output current is maintained at the set current. Output voltage  $V$  is determined by the equation  $V = I_s \times R_L$  and is a voltage that is less than voltage limit  $V_s$ . The actual voltage that is applied is not necessarily equal to the specified value.

## ■ Crossover point

The PMX-A series switches automatically between CV mode and CC mode according to the changes in the load. A crossover point is the point at which the mode switches.

For example, when operating in CV mode, if the load changes and the output current reaches the current limit, the PMX-A series automatically switches to CC mode to protect the load. Likewise, when operating in CC mode, if the output voltage reaches the voltage limit, the PMX-A series switches to CV mode.



## CV mode and CC mode operation example

This section uses a power supply (PMX35-3A) with a rated output voltage of 35 V and a rated output current of 3 A as an example.

A load resistance ( $R_L$ ) of 60  $\Omega$  is connected to the output terminals of the power supply. The output voltage and output current are set to 20 V and 0.5 A, respectively. In this case,  $R_c = 20 \text{ V}/0.5 \text{ A} = 40 \Omega$ . Because 60  $\Omega$  is greater than 40  $\Omega$  ( $R_L > R_c$ ), the power supply operates in CV mode. When you want to increase the voltage in CV mode, you can increase the voltage up to the voltage defined by the following equation:  $V_s = I_s \times R_L$ . Substituting the values, we obtain  $V_s = 0.5 \text{ A} \times 60 \Omega = 30 \text{ V}$ . If you try to increase the voltage above this point, the cross-over point is reached, and the power supply automatically switches to CC mode. To maintain operations in CV mode, increase the current limit.

Next, a load resistance ( $R_L$ ) of 25  $\Omega$  is connected to the output terminals of the power supply. The output voltage and output current are set to 20 V and 0.5 A, respectively. In this case,  $R_c = 20 \text{ V}/0.5 \text{ A} = 40 \Omega$ . Because 40  $\Omega$  is greater than 25  $\Omega$  ( $R_L < R_c$ ), the power supply operates in CC mode. When you want to increase the current in CC mode, you can increase the current up to the current defined by the following equation:  $I_s = V_s/R_L$ . Substituting the values, we obtain  $I_s = 20 \text{ V}/25 \Omega = 0.8 \text{ A}$ . If you try to increase the current above this point, the cross-over point is reached, and the power supply automatically switches to CV mode. To maintain operations in CC mode, increase the voltage limit.

# Using the PMX-A Series as a CV or CC Power Supply

When the PMX-A series is used as a constant-voltage power supply, the set current is the limit to the current that can flow through the load.

When the PMX-A series is used as a constant-current power supply, the set voltage is the limit to the voltage that can be applied to the load.

If the specified limit is reached, the PMX-A series automatically switches its operation mode. When the PMX-A series switches its operation mode, the lit LED in the display area (CV LED or CC LED) changes to indicate the switch.

See p.17

## 1 Turn the **POWER** switch off.

## 2 Connect the load to the output terminals.

## 3 Turn the **POWER** switch on.

If the OUTPUT LED in the display area is lit, press OUTPUT to turn the output off.

## 4 Press **SET** to change to the setting display.

The SET key lights.

See p.23

## 5 Turn the **VOLTAGE** knob to set the voltage.

PMX18-2A	0 V to 18.9 V
PMX18-5A	0 V to 18.9 V
PMX35-1A	0 V to 36.75 V
PMX35-3A	0 V to 36.75 V

PMX70-1A	0 V to 73.5 V
PMX110-06A	0 V to 115.5 V
PMX250-0.25A	0 V to 262.5 V
PMX350-0.2A	0 V to 367.5 V
PMX500-0.1A	0 V to 525.0 V

## 6 Turn the **CURRENT** knob to set the current.

PMX18-2A	0 A to 2.1 A
PMX18-5A	0 A to 5.25 A
PMX35-1A	0 A to 1.05 A
PMX35-3A	0 A to 3.15 A

PMX70-1A	0 A to 1.05 A
PMX110-06A	0 A to 0.63 A
PMX250-0.25A	0 A to 0.262 A
PMX350-0.2A	0 A to 0.21 A
PMX500-0.1A	0 A to 0.105 A

## 7 Press **OUTPUT** to turn output on.

The SET key turns off, and the OUTPUT LED in the display area lights. The voltage and current are generated from the output terminals. When the PMX-A series is operating as a constant-voltage power supply, the CV LED in the display area lights. When the PMX-A series is operating as a constant-current power supply, the CC LED lights.

Even when the output is on, you can set the voltage and current by carrying out step 5 and step 6 while checking the actual output voltage or current.

See p.36

You can use the CONFIG settings to set the output-on startup state (CF08: prioritize CC or CV). Set this according to the operation mode that you are using. You can prevent overshoot from occurring when the output is turned on by prioritizing CV when using the PMX-A series as a constant-voltage power supply and by prioritizing CC when using the PMX-A series as a constant-current power supply.

If external control is in progress, you cannot set the output-on startup state (prioritize CC/ prioritize CV).

# Protection Functions and Alarms

The PMX-A series is equipped with the following protection functions.

- Overvoltage protection (OVP)
- Overcurrent protection (OCP)
- Overheat protection (OHP)

## Alarm occurrence and clearing alarms

### Alarm occurrence

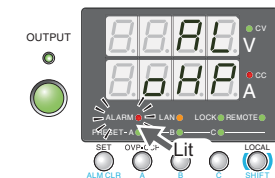

OHP alarm indication

When a protection function is activated, the PMX-A series behaves as follows.

- Output Off
- The ALARM LED in the front panel display area lights to indicate that an alarm has occurred. The voltmeter indicates the cause of the alarm.
- The alarm signal is generated from pin 13 of the J1 connector.

### Clearing alarms

Press ALM CLR (SHIFT + SET) or turn off the POWER switch. Fix the problem that caused the alarm, and turn the POWER switch back on.

If an alarm still occurs even after you have corrected all the causes of alarms, the PMX-A series may be malfunctioning. Stop using it immediately, and contact your Kikusui agent or distributor.

For an explanation of the problems that cause the alarms, see the explanation of each protection function.

### Alarm signal

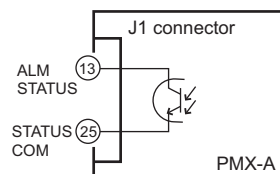

Maximum voltage: 30 V  
Maximum current: 8 mA

The alarm signal is isolated from other terminals through an open collector photo-coupler.

The CV, CC, output-on, and power-on signals share a common ground.

## Protection function activation

### Overvoltage protection (OVP) and overcurrent protection (OCP)

The overvoltage protection function is activated when the output terminal voltage exceeds the set voltage (OVP trip point).

The overcurrent protection function is activated when the output current exceeds the set current (OCP trip point).

The OVP and OCP trip points need to be set to appropriate values. Immediately after you purchase the PMX-A series or immediately after a load is changed, set the OVP and OCP trip points to values that are appropriate for the load.

#### ■ Setting the OVP and OCP trip points

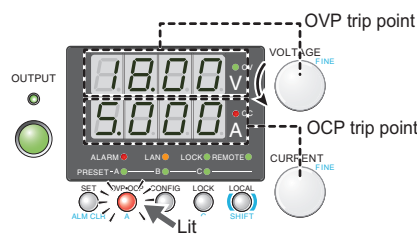

The PMX-A series' OVP operates according to the output terminal voltage. If you want to activate the protection function according to the voltage across the load, take the voltage drop in the load cable into consideration when you set the OVP trip point.

OVP and OCP trip point displays

#### 1 Press OVP • OCP.

The OCP • OVP key lights, and the OVP trip point and OCP trip point are displayed in the display area.

#### 2 While viewing the panel display, turn the VOLTAGE knob to set the OVP trip point or the CURRENT knob to set the OCP trip point.

Hold down SHIFT while you turn the VOLTAGE knob or CURRENT knob to make small changes to the value.

OVP setting range: 10 % to 110 % of the rated output voltage

OCP setting range: 10 % to 110 % of the rated output current

	OVP setting	OCP setting
PMX18-2A	1.8 V to 19.8 V	0.2 A to 2.2 A
PMX18-5A	1.8 V to 19.8 V	0.5 A to 5.5 A
PMX35-1A	3.5 V to 38.5 V	0.1 A to 1.1 A
PMX35-3A	3.5 V to 38.5 V	0.3 A to 3.3 A
PMX70-1A	7.0 V to 77.0 V	0.1 A to 1.1 A
PMX110-0.6A	11.0 V to 121.0 V	0.06 A to 0.66 A
PMX250-0.25A	25.0 V to 275.0 V	0.025 A to 0.275 A
PMX350-0.2A	35.0 V to 385.0 V	0.02 A to 0.22 A
PMX500-0.1A	50.0 V to 550.0 V	0.01 A to 0.11 A

#### 3 Press OCP • OVP to finalize the setting.

The OCP • OVP key turns off, and the PMX-A series returns to the measured value display.

See p.23

## ■ Checking OVP and OCP operation

To check the operation of the OVP function, carry out the procedure below.

- 1 Check that the **OUTPUT LED** in the display area is turned off.
- 2 Set the output voltage to a value lower than the OVP trip point.
- 3 Press **OUTPUT** to turn output on.  
The **OUTPUT LED** lights.
- 4 **Slowly turn the VOLTAGE knob clockwise.**  
When the output voltage exceeds the OVP trip point, the front panel display area's **ALARM LED** lights to indicate that the OVP function has been activated.

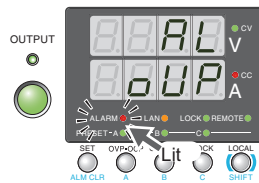

OVP activation alarm indication

- 5 Check that output has turned off.
- 6 Turn the **POWER** switch off.

To check the operation of the OCP function, carry out the procedure below.

- 1 **Short the output terminals.**
- 2 Turn the **POWER** switch on.
- 3 Check that the **OUTPUT LED** in the display area is turned off.
- 4 Set the output current to a value lower than the OCP trip point.
- 5 Press **OUTPUT** to turn output on.  
The **OUTPUT LED** lights.
- 6 **Slowly turn the CURRENT knob clockwise.**  
When the output current exceeds the OCP trip point, the front panel display area's **ALARM LED** lights to indicate that the OCP function has been activated.

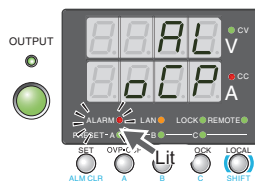

OCP activation alarm indication

- 7 Check that output has turned off.

If you do not change the output settings, the OVP or OCP function will be activated again.

## Overheat protection (OHP)

The overheat protection function is activated when the PMX-A series' internal temperature rises to an abnormal level.

- When the PMX-A series is used in an environment that exceeds its operating ambient temperature range (0 °C to +40 °C).
- When the PMX-A series is used with its air inlet or outlet port blocked.
- When the fan motor has stopped.

If you do not fix the problem that caused the OHP to be activated, OHP will be activated again even if you turn the POWER switch off and on.

# CONFIG Settings

Use the CONFIG settings to set the PMX-A series' system configuration. You can set and display the following parameters in the CONFIG settings.

In the "Note" column, "A" indicates a parameter that is applied when the PMX-A series exits from CONFIG settings, "B" indicates a parameter that is applied when the PMX-A series is turned on, and "C" indicates a parameter that is applied when CF34 is executed.

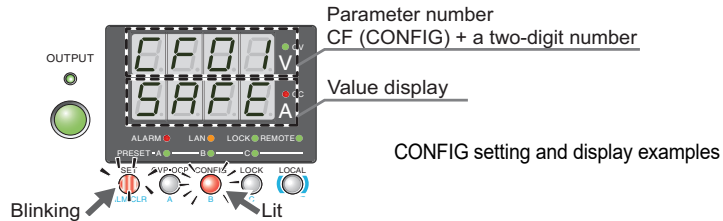

Display switching	Parameter number	Setting or display description	Note
SYSTEM	CF00	Resets the panel settings	A
	CF01	Power-on output status parameter	B
	CF02	Memory content display parameter	A
	CF03	Key lock parameter	A
	CF04 <sup>1 2</sup>	CC control using an external voltage or external resistance	A
	CF05 <sup>1 2</sup>	CV control using an external voltage or external resistance	A
	CF06 <sup>1 2</sup>	External control parameter for turning output on and off	A
	CF07 <sup>2</sup>	External control logic parameter for turning output on and off	A
	CF08 <sup>3</sup>	Output-on startup state parameter	A
INTERFACE	CF20	Remote interface parameter	B
	CF21	SCPI communication error display parameter	A
LAN	CF30	DHCP parameter	B or C
	CF31	AUTO IP address parameter	B or C
	CF32	MANUAL IP address parameter	B or C
	CF33	Resets the LAN interface settings (LCI)	A
	CF34	Restarts the LAN interface (REBOOT)	A
	CF35	IP address display (1)	—
	CF36	IP address display (2)	—
	CF37	IP address display (3)	—
	CF38	IP address display (4)	—
	CF39	MAC address display (1) and (2)	—
	CF40	MAC address display (3) and (4)	—
CF41	MAC address display (5) and (6)	—	
USB	CF50	VID (vendor ID) display	—
	CF51	PID (product ID) display	—

- 1 This parameter affects the PMX-A series when the panel settings are reset (CF00).
- 2 The item can be configured only when the output is off.
- 3 This parameter cannot be set if external control is in progress.

## Setting and viewing CONFIG parameters

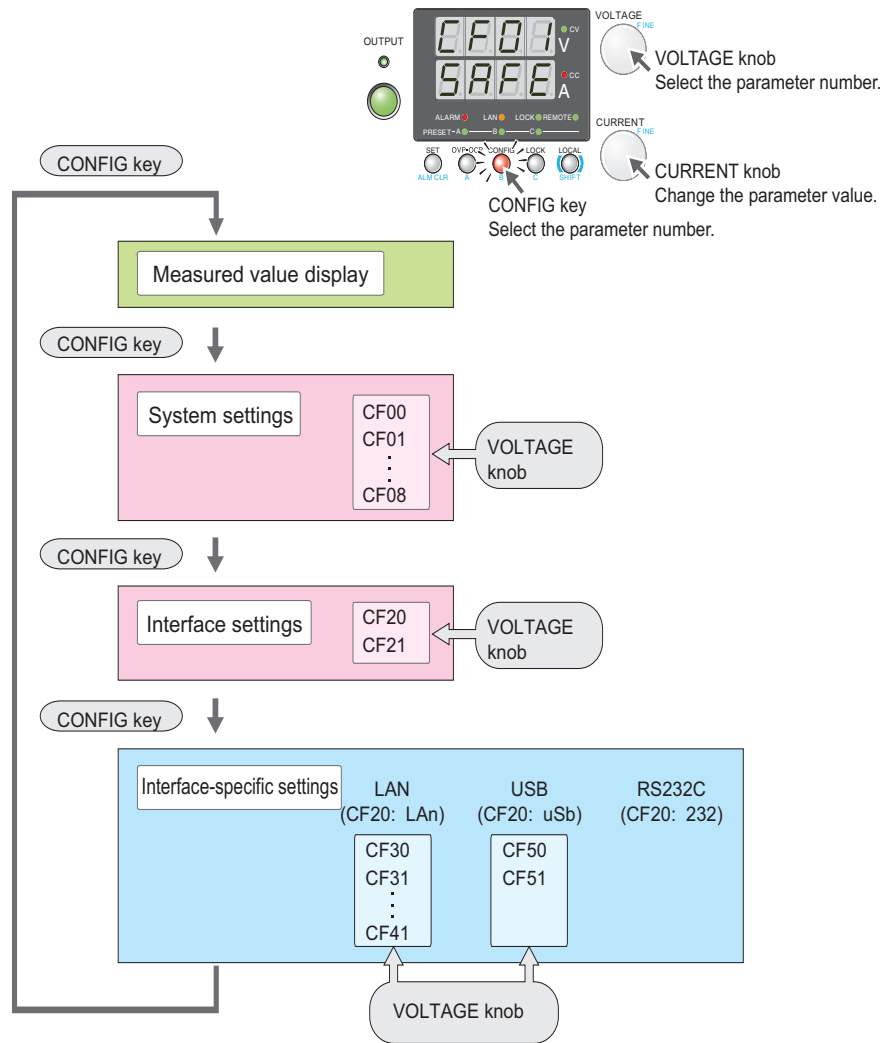

CF00, CF33, and CF34 are used to execute operations. CF35 to CF41, CF50, and CF51 are used to display the status of the PMX-A series. You cannot set the values of any of these CONFIG parameters.

For CF00, CF33, and CF34, the SET key is used to apply the settings. The settings have not yet been applied when the SET key is blinking.





## Specifying the CONFIG settings (Excluding resetting the settings, resetting the LAN interface settings, and restarting the LAN interface)

 Memo



Press CONFIG or turn the VOLTAGE knob to switch between the parameter numbers. These two methods switch between the parameter numbers differently.

 See p.31

- 1 Press CONFIG.**

The CONFIG key lights and the SET key blinks. The voltmeter displays the parameter number (CF00) . The ammeter displays the corresponding setting (rST) .
- 2 Press CONFIG or turn the VOLTAGE knob to select the number of the parameter that you want to set.**

When you press CONFIG, the PMX-A series switches between the parameter numbers in the following order. The displayed parameter numbers vary depending on the interface that you select.

LAN: CF00 → CF20  → CF30 → measured value display  
 USB: CF00 → CF20  → CF50 → measured value display  
 RS232C: CF00 → CF20  → measured value display

When you turn the VOLTAGE knob, the PMX-A switches between the parameter numbers. The parameter numbers that are displayed when you turn the VOLTAGE knob are those within the ranges defined by the parameter numbers that pressing the CONFIG key switches between.
- 3 Turn the CURRENT knob to change the value of the parameter.**

There are parameters whose values are applied immediately, those whose values are applied after the power is turned off and then back on, and those whose values are applied when CF33 or CF34 is executed.
- 4 To specify or display other parameters, repeat step 2 and step 3. To stop specifying CONFIG settings, proceed to step 5.**
- 5 Hold down CONFIG until the measured value display appears, or LOCAL.**

The PMX-A series exits from CONFIG settings.  
 If you changed a parameter with the “Note” column indicated as “A” in the CONFIG list on page 31, the change is applied.



You can also press SET to exit from CONFIG settings.

## Resetting the settings (CF00)

 Memo

You can cancel the settings using CONFIG.

- 1 Press CONFIG once (CF00).**

The CONFIG key lights and the SET key blinks.  
 The voltmeter displays the parameter number (CF00) . The ammeter displays the corresponding setting (rST) .
- 2 Press SET, which is blinking, again.**

The settings are applied. The measured value display appears.  
 While the parameter number and the setting are blinking, no new settings will be applied until you press SET.

## Resetting the LAN interface settings (CF33) and restarting (CF34)

### 1 Press CONFIG twice to select the LAN interface **LAN**, and then press it again.

The CONFIG key lights.

The voltmeter displays the parameter number (CF30) **CF30**. The ammeter displays the corresponding setting (on) **0000**.

### 2 Turn the VOLTAGE knob to select the number of the parameter you want to set.

If you are resetting the LAN interface settings, the voltmeter displays “CF33 **CF33**,” the ammeter displays “LCi **0000**,” and the SET key blinks.

If you are restarting, the voltmeter displays “CF34 **CF34**,” the ammeter displays “boot **0000**,” and the SET key blinks.

### 3 Press SET.

The CONFIG key turns off. The SET key and the displayed settings blink.

### 4 Press SET again.

The settings are applied.

The SET key and displayed settings stop blinking (remain lit), and the OVP • OCP and CONFIG keys light.

After approximately 4 to 5 seconds, the measured value display appears, and the settings are applied.

#### ★ Memo

If you want to cancel the settings, press CONFIG before you press SET.

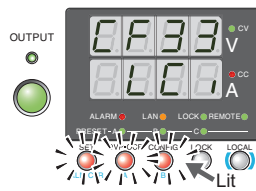

Display example of CF33 being

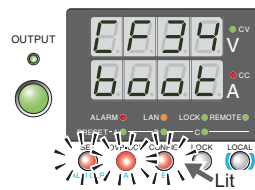

Display example of CF34 being applied

## CONFIG parameter details

The CONFIG parameters are explained in detail below.

 [Communication Interface Manual](#)

### CF00 Resets the panel settings

Resets the panel settings. The following settings will be reset. When the settings are reset, the PMX-A series' settings take on the same values as they do when an \*RST command is received.

- Output voltage
- Output current
- Overvoltage protection
- Overcurrent protection (CF06)
- Output on/off at power-on
- Constant current control using an external voltage or external resistance (CF04)
- Constant voltage control using an external voltage or external resistance (CF05)
- External control for turning output on and off (CF06)

Display	Description
rSt	Resets the panel settings

 p.11

### CF01 Power-on output status parameter

Sets the output condition that the PMX-A series will be in when the power is turned on. When you are using an external contact to turn the output off, this parameter is invalid. This parameter is applied when you turn the POWER switch off and on.

Value	Description
SAFE	The PMX-A series starts with the output turned off (factory default setting).
Auto	The PMX-A series starts with the output set to the condition that was used immediately before the POWER switch was turned off.
ForC	The PMX-A series starts with the output turned on.

 p.40

### CF02 Memory content display parameter

Sets whether to display the saved contents in the preset memory before recalling them. You can use this CONFIG parameter if you forget what settings have been saved or if you want to view the saved settings.

Value	Description
oFF	The saved contents of preset memory will be recalled without displaying them.
on	The saved contents of preset memory will be displayed and then recalled after confirmation (factory default setting).

 p.41

### CF03 Key lock parameter

The key lock feature locks the panel. Select from the following three values.

Value	Description
Loc1	Only the OUTPUT key and recalling of settings using memory keys A, B, and C are allowed.
Loc2	Only the OUTPUT key can be used.
Loc3	All keys and rotary operations are disabled (factory default setting).

### CF04 CC control using an external voltage or external resistance

See p.35, p.40, p.51

Selects whether the output current will be controlled by an external voltage or external resistance (the J1 connector). This is set to “nonE” when the panel settings are reset (CF00). The item can be configured only when the output is off.

Value	Description
nonE	CC control is not performed (factory default setting).
VoLt	CC control using external voltage will be performed.
rES	CC control using external resistance will be performed.

### CF05 CV control using an external voltage or external resistance

See p.49

Selects whether the output voltage will be controlled by an external voltage or external resistance (the J1 connector). This is set to “nonE” when the panel settings are reset (CF00). The item can be configured only when the output is off.

Value	Description
nonE	CV control is not performed (factory default setting).
VoLt	CV control using external voltage will be performed.
rES	CV control using external resistance will be performed.

### CF06 External control parameter for turning output on and off

See p.53

Selects whether an external contact (the J1 connector) will be used to turn output on and off. This is set to “oFF” when the panel settings are reset (CF00). The item can be configured only when the output is off.

Value	Description
oFF	External control is not performed (factory default setting).
on	External control is performed.

### CF07 External control logic parameter for turning output on and off

See p.53

Sets the logic that is used when an external contact (the J1 connector) is used to turn output on and off. The item can be configured only when the output is off.

Value	Description
Lo	The output is turned on with a low signal (0 V to 0.5 V) or short circuit (factory default setting).
Hi	The output is turned on with a high signal (4.5 V to 5 V) or open circuit.

### CF08 Output-on startup state parameter

See p.26

Sets the operation mode to be prioritized when the output is turned on. This parameter cannot be set if external control is in progress.

Value	Parameter description
CC	CC (constant current) is prioritized.
CV	CV (constant voltage) is prioritized (factory default setting).

### CF20 Remote interface parameter

Selects the remote interface that you want to use.  
This parameter is applied when you turn the POWER switch off and on.

Value	Description
LAN	LAN will be used (factory default setting).
uSb	USB will be used.
232	RS232C is used.

### CF21 SCPI communication error display parameter

Selects whether to display communication errors. The errors are only displayed when you are using the SCPI language.

Value	Description
oFF	SCPI communication errors are not displayed (factory default setting).
on	SCPI communication errors are displayed.

### CF30 DHCP parameter

Selects whether or not to obtain an IP address from a DHCP server. If you are using a fixed IP address, set this to oFF.  
This parameter is applied when you turn the POWER switch off and on or when you restart the LAN interface (CF34).

Value	Description
oFF	A DHCP server is not used.
on	A DHCP server is used (factory default setting).

### CF31 AUTO IP address parameter

Set whether to automatically attain an IP address when you are not using or can not use a DHCP server. The address that is assigned by the AUTO IP function is 169.254.x.x (where x is a number between 0 and 254). If you are using a fixed IP address, set this to oFF. This parameter is applied when you turn the POWER switch off and on or when you restart the LAN interface (CF34).

Value	Description
oFF	The AUTO IP function will not be used.
on	The AUTO IP function will be used (factory default setting).

### CF32 MANUAL IP address parameter

Set whether to manually specify an IP address when you are not using or can not use a DHCP server. If you are using a fixed IP address, set this to on.  
This parameter is applied when you turn the POWER switch off and on or when you restart the LAN interface (CF34).

Value	Description
oFF	The MANUAL IP function will not be used (factory default setting).
on	The MANUAL IP function will be used.

### CF33 Resetting the LAN interface settings (LCI)

See p.42

This parameter resets the LAN interface settings to their factory default settings. You can use this if you forget the security password or IP address.

Display	Description
LCi	The LAN interface settings will be reset to their factory default settings.

### CF34 Restarts the LAN interface (REBOOT)

This parameter restarts the LAN interface. The LAN interface settings that you have specified do not change.

Display	Description
boot	The LAN interface settings are saved, and the interface is restarted.

### CF35 to CF38 IP address display

These parameters display the set IP addresses. These parameters are only displayed when you are using the LAN interface.

The IP addresses are just displayed; they cannot be set from the panel. To set a fixed IP address, access the PMX-A series through a Web browser. When you access the PMX-A series through a Web browser, do so under conditions in which a DHCP server or AUTO IP can be used.

For details on the Web interface, see the Communication Interface Manual.

Parameter number	Display	Description
CF35	0 to 255	Displays the first IP address number
CF36	0 to 255	Displays the second IP address number
CF37	0 to 255	Displays the third IP address number
CF38	0 to 255	Displays the fourth IP address number

### CF39 to CF41 MAC address display

These parameters display the set MAC addresses.

The MAC addresses are just displayed; they cannot be set from the panel.

MAC addresses are set to 00.0F.CE.xx.xx (where x is a hexadecimal number between 0 and F).

Parameter number	Display	Description
CF39	00.0F	Displays the first and second MAC address numbers
CF40	CE.xx	Displays the third and fourth MAC address numbers
CF41	xx.xx	Displays the fifth and sixth MAC address numbers

Display example of the MAC address  
"00.0F.CE.11.22.33:"



CF39: 00.0F



CF40: CE.11



CF41: 22.33

### CF50 Vendor ID (VID) display

This displays the USB vendor ID.

Display	Description
0b3E	0x0B3E

## CF51 Product ID display

This displays the USB product ID.

Display	Description
1029	0x1029

# Preset Memory Function

2

Basic Functions

The PMX-A series has three preset memory entries (A, B, and C) where you can save combinations of voltage and current settings. Saved settings can be recalled from the preset memory when needed. To select the preset memory entry to save to or recall from, hold down SHIFT and press A, B, or C.

Recalling is executed immediately when a preset memory entry is specified. If you keep specifying a preset memory entry by holding down the keys, the present settings are saved to the entry area.

## Saving settings to preset memory

### NOTE

When you save settings to a preset memory entry, release the memory key first. If you release SHIFT first, the operation indicated in black characters above the key will be activated.

1

### Press SET.

The SET key lights, and the present voltage and current settings are displayed on the panel.

2

### While viewing the values displayed on the panel, turn the VOLTAGE knob to set the preset memory voltage and turn the CURRENT knob to set the preset memory current.

3

### Press SHIFT+the memory key that corresponds to the memory entry that you want to save the settings to (A, B, or C). Hold the keys down until the corresponding PRESET LED turns on.

The PRESET A, PRESET B, or PRESET C LED in the display area—whichever one corresponds to the memory entry that you selected—lights to indicate that the preset memory entry has been saved.

By following step 3, you can save preset memory entries when the output is on and the measured value display is being shown (the SET key is off). After you save a preset memory entry, press SET to view the preset memory.

## Recalling preset memory entries

You can recall memory entries from the measured value display (when the SET key is off) and from the setting display (when the SET key is lit).

On the measured value display, the measured values continue to be displayed even after the recalling of the preset memory entry is complete.

On the setting display, the settings recalled from the preset memory are displayed.

If the output is on, the values in the preset memory entry are applied to the output the moment that the preset memory entry is recalled (the moment that the settings are applied).

See p.35

There are two methods to recall a preset memory entry. One method is to display the saved contents for confirmation and then recall (CF02: on). The other is to recall immediately without displaying the contents (CF02: oFF).

### NOTE

If you hold down SHIFT+the memory key (A, B, or C) that corresponds to the preset memory entry that you want to recall from, the preset values in use will be saved to the preset memory entry instead.

## Displaying the saved contents for confirmation and then recalling

### 1 While holding down SHIFT, press the appropriate memory key (A, B, or C).

The SET key, the PRESET LED of the memory to recall from (A, B, or C), and the contents (voltage and current) of the recalled preset memory that are shown in the display area blink. If you press another memory key while holding down SHIFT, the contents of the corresponding memory appear blinking.

### 2 Check the displayed settings, and then press SET.

The LED that corresponds to the preset memory entry that you have recalled (PRESET A, B, or C) lights.

#### ★ Memo

Press LOCAL to cancel recalling.

## Recalling without displaying the saved contents

### 1 Use the CONFIG settings to set the PMX-A series to hide the saved contents of preset memory entries (CF02: oFF).

### 2 While holding down SHIFT, press the appropriate memory key (A, B, or C).

The LED that corresponds to the preset memory entry that you have recalled (PRESET A, B, or C) lights.

#### ★ Memo

The one-step recall feature is convenient when you know the contents that have been saved to the memory.



# Locking Panel Controls (Key lock)

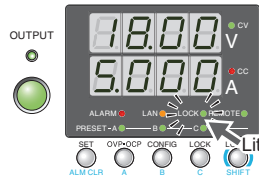

The PMX-A series' key lock function prevents you from accidentally changing the settings.

See p.35

The following three key lock modes are available. Use CONFIG parameter CF03 to set the mode.

- Key lock 1 (Loc1): Lock all keys except the OUTPUT and memory A, B, and C keys.
- Key lock 2 (Loc2): Locks all keys except the OUTPUT key.
- Key lock 3 (Loc3): Lock all keys and the rotary knob.

**1** Configure all the settings, such as the output voltage and output current, as necessary.

**2** Hold down LOCK until the LOCK LED in the display area lights. When the LOCK LED lights, the keys are locked.

To unlock the keys, hold down LOCK again until the LOCK LED turns off.

2

Basic Functions

# Remote Control

You can remotely control the product from a PC using SCPI commands through the RS232C, LAN, or USB interface. Moreover, with the LAN interface, you can use the Web browser interface to remotely control the product from a virtual front panel. For details on remote control, see the Communication Interface Manual.

## Switching from Remote Mode to Local Mode

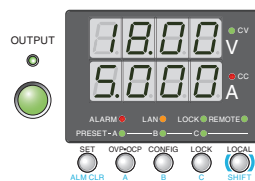

To switch the PMX-A series to local mode from the front panel, press LOCAL.

# Factory Default Settings (Initialization)

If you hold down LOCK and LOCAL and turn the POWER switch on, the PMX-A series will be reset to the factory default settings.

The factory default settings are shown below.

## ■ Basic settings

Basic item	Description
Output voltage	0 V
Output current	Maximum settable current
OVP (overvoltage protection)	110 % of the rated output voltage
OCP (overcurrent protection)	110 % of the rated output current
Preset memory values A/ B/ C	Voltage: 0 V, Current: Maximum settable current

## ■ CONFIG settings

Parameter number	CONFIG parameter	Description
CF01	Power-on output status parameter	SAFE (the PMX-A series starts with the output turned off)
CF02	Memory content display parameter	ON (displayed)
CF03	Key lock parameter	LOC3 (all keys and the rotary knob are locked)
CF04	CC control using an external voltage or external resistance	NONE (disabled)
CF05	CV control using an external voltage or external resistance	NONE (disabled)
CF06	External control parameter for turning output on and off	OFF (disabled)
CF07	External control logic parameter for turning output on and off	LO (a low signal turns output on) <sup>1</sup>
CF08	Output-on startup state parameter	CV (CV is prioritized)
CF20	Remote interface parameter	LAN
CF21	SCPI communication error display parameter	OFF (not displayed)
CF30	DHCP parameter	ON (a server is used)
CF31	AUTO IP address parameter	ON (the AUTO IP function is used)
CF32	MANUAL IP address parameter	OFF (the MANUAL IP address function is not used)

1 LOW: 0 V to 0.5 V, or a short circuit



# 3

---

## External Control

This chapter explains external control and external monitoring using the J1 connector.

# General Description

You can use the J1 connector on the rear panel of the PMX-A series to perform the following types of external control.

- Output voltage control  
Control using an external voltage or external resistance
- Output current control  
Control using an external voltage or external resistance
- Turning output on and off using an external contact
- Monitoring operation modes

## About the J1 Connector



J1 connector cover

The PMX70-1A, PMX110-0.6A, PMX250-0.25A, PMX350-0.2A, and PMX500-0.1A are factory shipped with a cover is attached to the J1 connector.

If it is damaged or lost, contact your Kikusui agent or distributor.



### Risk of electric shock.

**For safety reasons, Be sure to attach the cover when you are not using the J1 connector.**

The J1 connector for external control is the D-sub 25-pin connector on the rear panel. The cable is not supplied with the product. It must be obtained separately.

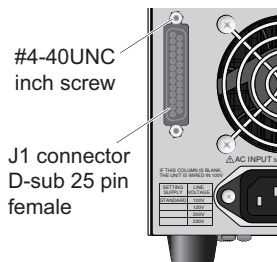

- Connector on the rear panel  
D-sub 25-pin female connector  
Made by TE Connectivity (former AMP)
- Compatible connector (plug)  
D-sub 25-pin male plug, with fix screw

To avoid malfunctions caused by noise, use shielded D-sub 25-pin connectors and a cable that is 3 m or less in length.

See p. 87

A connector kit option, OP01-PMX (749809-9 DB25), is available for connecting to the J1 connector. The connector kit is constructed of connector parts made by TE Connectivity (former AMP). For information about how to use these components, see the TE Connectivity (former AMP) catalogs.

For information about how to obtain these tools or replacement parts, contact your Kikusui agent or distributor.

Connector type	5747461-3 [ made by TE Connectivity (former AMP) ]
Plug type	745211-7 [ made by TE Connectivity (former AMP) ]
Wire diameter	AWG26 to AWG22
Manual pressure welding tool	Handle assembly 58074-1 [ made by TE Connectivity (former AMP) ] Head assembly 58063-2 [ made by TE Connectivity (former AMP) ]
Insertion/extraction tool	91232-1 [ made by TE Connectivity (former AMP) ] or equivalent

### J1 connector pin arrangement

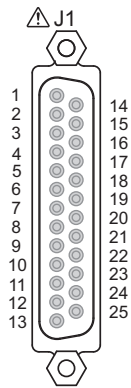

Pin number positions when you are facing the rear panel

Pin No.	Signal name	Description
1	VMON	Output voltage monitor; outputs 0 V to 10 V for 0 % to 100 % of the rated output voltage.
2	IMON	Output current monitor; outputs 0 V to 10 V for 0 % to 100 % of the rated output current.
3	ACOM	External signal common for pins 1, 2, 4, and 14. <sup>1</sup>
4	EXT-V CV CONT	Output voltage control using external voltage; receives 0 V to 10 V to output 0 % to 100 % of the rated voltage.
5	ACOM	External signal common for pins 1, 2, 4, and 14. <sup>1</sup>
6	EXT-R CV CONT	Output voltage control using external resistance; uses 0 Ω to 10 kΩ to output 0 % to 100 % of the rated voltage.
7	EXT-R CV CONT COM	Common for output voltage control using external resistance.
8	N.C.	Not connected.
9	N.C.	Not connected.
10	N.C.	Not connected.
11	CV STATUS	On when the PMX-A series is in CV mode (open-collector output from a photocoupler). <sup>2</sup>
12	CC STATUS	On when the PMX-A series is in CC mode (open-collector output from a photocoupler). <sup>2</sup>
13	ALM STATUS	On when a protection function (OVP, OCP, or OHP) is activated (open-collector output from a photocoupler). <sup>2</sup>
14	EXT-V CC CONT	Output current control using external voltage; receives 0 V to 10 V to output 0 % to 100 % of the rated current.
15	ACOM	External signal common for pins 1, 2, 4, and 14. <sup>1</sup>
16	EXT-R CC CONT	Output current control using external resistance; uses 0 Ω to 10 kΩ to output 0 % to 100 % of the rated current.
17	EXT-R CC CONT COM	Common for output current control using external resistance.
18	OUT ON/OFF CONT	Output on/off control using external contact input.
19	DCOM	External signal common for pin 18. <sup>1</sup>
20	N.C.	Not connected.
21	N.C.	Not connected.
22	N.C.	Not connected.
23	OUT ON STATUS	On when output is on (output through an open-collector photocoupler). <sup>2</sup>
24	PWR ON STATUS	On when the power is on (output through an open-collector photocoupler). <sup>2</sup>
25	STATUS COM	Status signal common for pins 11, 12, 13, 23, and 24.

1 During remote sensing, this is the negative electrode (-S) of sensing input. When remote sensing is not being performed, this is connected to the negative output.  
 2 Open collector output: maximum voltage 30 V, maximum current (sink) 8 mA; the status common is floating (isolation voltage or less), it is isolated from the control circuit.

# Output Terminal Insulation



**WARNING** Risk of electric shock. For safety reasons, even if the output terminal is grounded, make sure that the insulation capacity of the output terminal (including the sensing terminal) is greater than or equal to the isolation voltage of the PMX-A series. For the isolation voltage of each model, “Specifications” on page 71. If you cannot obtain a cable with sufficient rated voltage, secure adequate withstand voltage by passing the cable through an insulation tube with a withstand voltage greater than the isolation voltage of the PMX-A series.



**CAUTION** The signal cable may burn out. If the PMX-A series is to be controlled through an external voltage (Vext), do not ground the external voltage (leave it floating).

The cable and load that are connected to the output terminal (including the sensing terminal) must have an insulation capacity that is greater than or equal to the isolation voltage of the PMX-A series with respect to the chassis. Isolation voltage indicates the maximum allowed voltage that appears across the output terminal of the power supply unit and the protective conductor terminal (chassis terminal).

## When the output terminal is not grounded (floating)

The output terminal of the PMX-A series is isolated from the protective conductor terminal. If you connect the GND wire of the power cord to the ground terminal of the switchboard, the chassis of the PMX-A series is set to ground potential.

Pins 1 to 7 and 14 to 19 (for external control and output monitoring) of the rear panel J1 connector are at approximately the same electric potential as the PMX-A series' negative output terminal. Cables and devices that are connected to these pins must have an insulation capacity greater than or equal to the isolation voltage of the PMX-A series.

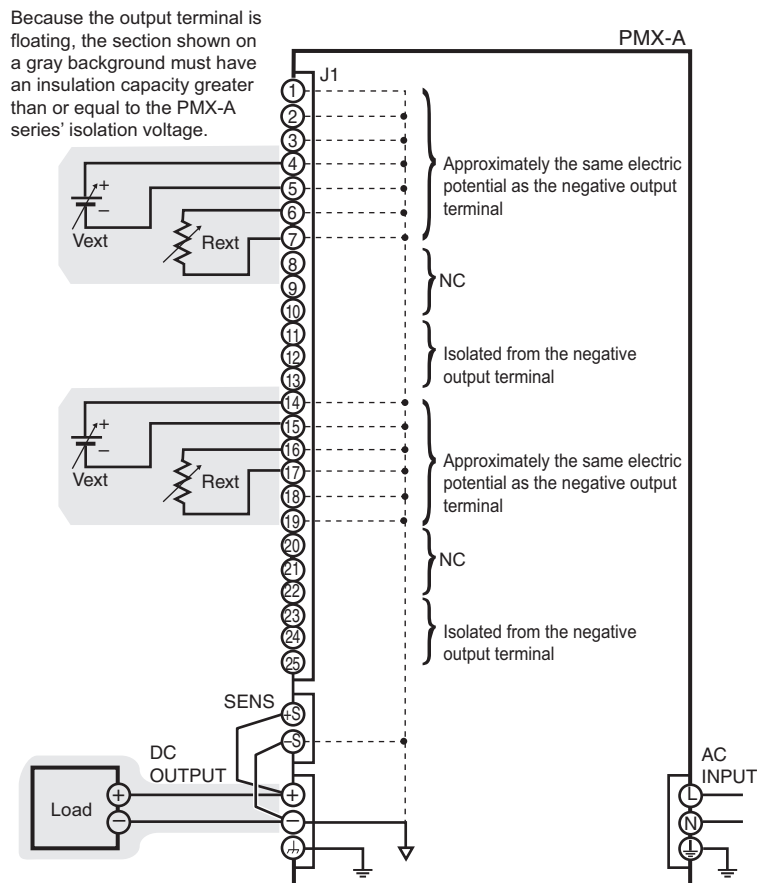

## When the output terminal is grounded

If the positive output terminal is connected to the chassis terminal, the positive output terminal is at ground potential. The cable and load that are connected to the output terminal (including the sensing terminal) will only require an insulation capacity that is greater than or equal to the maximum output voltage of the PMX-A series with respect to the chassis. There is no need to provide insulation that is greater than or equal to the isolation voltage of the PMX-A series.

The same holds true when the negative terminal is connected to the chassis terminal. The cable and load require an insulation capacity that is greater than or equal to the maximum output voltage of the PMX-A series.

For safety reasons, connect one of the output terminals to the chassis terminal unless your application requires the output terminals to be floating.

Because the positive output terminal is at ground potential, the section shown on a gray background must have an insulation capacity greater than or equal to the maximum output voltage relative to the chassis.

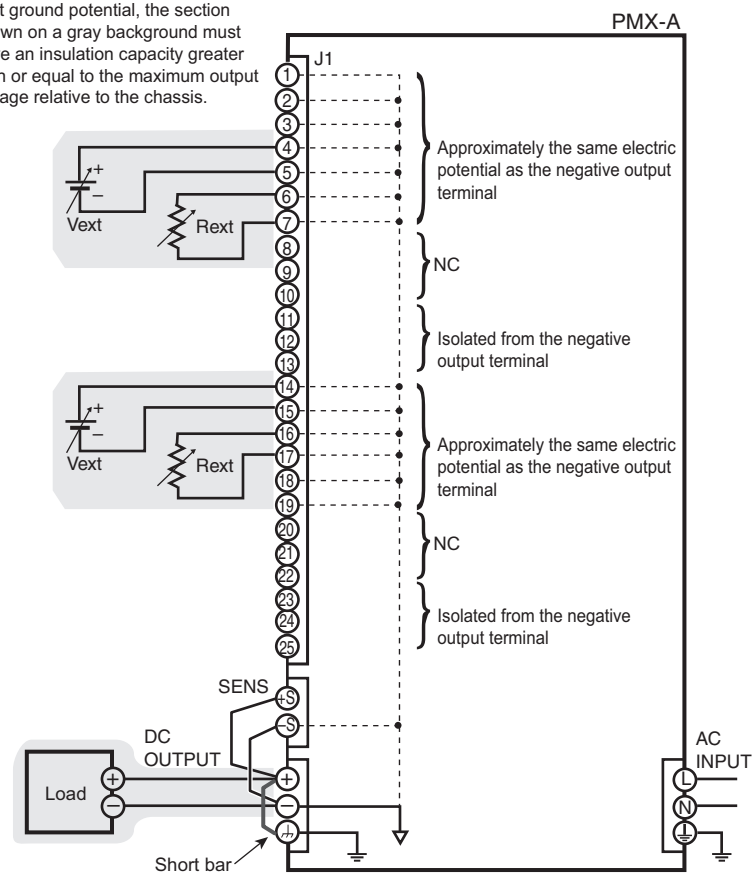

## Cautions when using the external voltage (Vext)

Connect the cables so that output is not shorted. See the following figures for examples of shorted output.

**CAUTION**

The signal cable may burn out.

- Do not connect the Vext output, that is, leave it floating.
- If you are connecting the shield to the Vext side, do not connect the shield to the output terminal of the PMX-A series.

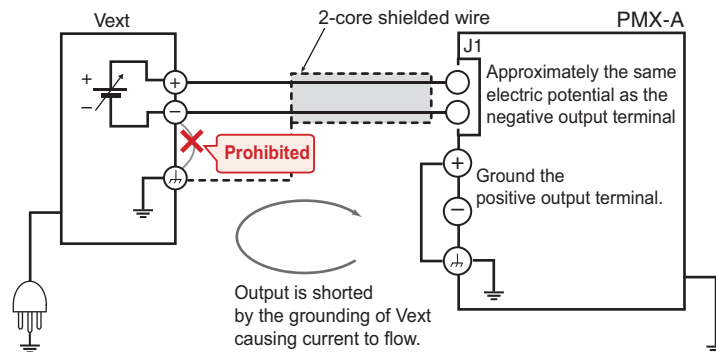

A connection in which the output is shorted by the grounding of Vext (example of a prohibited connection)

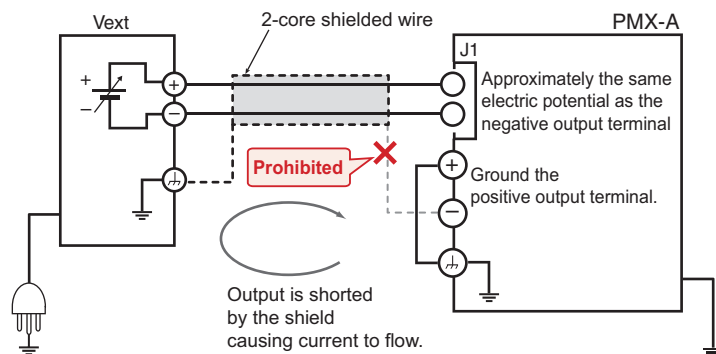

A connection in which the output is shorted by the shield (example of a prohibited connection)



# Output Voltage Control

This section explains how to control the output voltage using an external voltage ( $V_{ext}$ ) or an external variable resistor ( $R_{ext}$ ) of approximately 10 k $\Omega$ .

If the output voltage is being controlled, the panel display varies depending on the display status.

In setting display, the voltmeter displays .

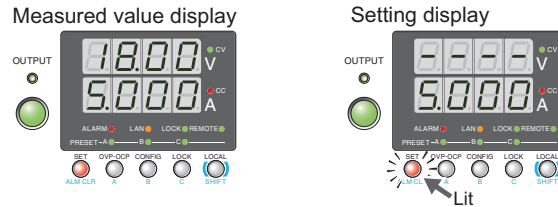

## Risk of electric shock.

- The insulation of  $V_{ext}$  or  $R_{ext}$  and the connected cable must be greater than or equal to the isolation voltage of the PMX-A series.  
For the isolation voltage of each model, “Specifications” on page 71.
- When using shielded cables for the connection, protect the uncovered sections of the shielded cable by using insulation tubes whose withstand voltage is greater than the PMX-A series’ isolation voltage.

## Control using an external voltage ( $V_{ext}$ )

 p. 36

To use an external voltage ( $V_{ext}$ ) to control the output voltage, set CV control using an external voltage or external resistance in the CONFIG settings to external voltage control (CF05: VoLt).

The output voltage ( $E_o$ ) varies in the range of 0 to the rated output voltage ( $E_{rtg}$ ) when the external voltage ( $V_{ext}$ ) is changed in the range of 0 V to 10 V.

$$\text{Output voltage } E_o = E_{rtg} \times V_{ext} / 10 \text{ [V]}$$

$E_{rtg}$ : Rated output voltage [V]

$V_{ext}$ : External voltage [V]



- The signal cable may burn out. Do not connect the  $V_{ext}$  output, that is, leave it floating. If you do, the PMX-A series may malfunction.
- Pay careful attention to the polarity of  $V_{ext}$ .
- Do not apply a voltage of 10.5 V or greater, or a reverse voltage across the external voltage control pins.

### External voltage (Vext) connection

Use a low-noise, stable voltage source for Vext. The noise in Vext is multiplied by the amplification factor of the PMX-A series and appears in the output. Therefore, the output ripple noise may not meet the specifications of the PMX-A series.

To reduce the influence of noise on the output, connect a 2-core shielded wire or a twisted-pair wire across Vext, and keep the wire as short as possible. If the wiring between the PMX-A series and the external contact is long, it becomes easy for noise to influence the operation of the PMX-A series. Even if you use cables that are designed to suppress noise, the PMX-A series may not operate properly.

If you use a shielded cable, connect the shield to the negative output terminal. If the shield needs to be connected to the Vext side, see "Cautions when using the external voltage (Vext)".

Use pins 4 and 5 of the J1 connector.

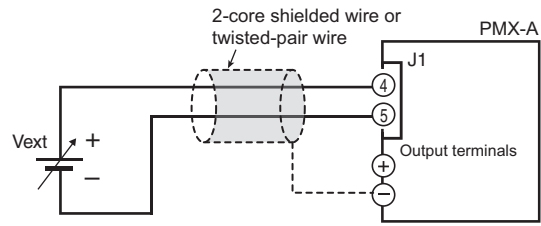

See p. 48

### Control using an external resistance (Rext)

See p. 36

By using an external resistance (Rext) to change the reference voltage's voltage-divider ratio, you can change the output voltage (Eo) to a value in the range of 0 to the 100 % of the rated output voltage (Ertg).

To use an external resistance (Rext) to control the output voltage, set CV control using an external voltage or external resistance in the CONFIG settings to external resistance control (CF05: rES).

The output voltage (Eo) varies in the range of 0 to the rated output voltage (Ertg) when the external resistance (Rext) is changed in the range of 0 Ω to 10 kΩ.

$$\text{Output voltage } E_o = E_{rtg} \times R_{ext} / 10 \text{ [V]}$$

Ertg: Rated output voltage [V]

Rext: External resistance [kΩ]

### External resistance (Rext) connection

**NOTE**

Connect the external resistor securely. If the external resistor (Rext) becomes loose, an excessive voltage may be applied to the load.

For Rext, use a resistor that is rated at approximately 10 kΩ, 1/2 W or greater, that has a low temperature coefficient, and that will change little over time. Examples of such resistors are metal film or wire wound resistors.

To reduce the influence of noise on the output, connect a 2-core shielded wire or a twisted-pair wire across Rext, and keep the wire as short as possible. If the wiring between the PMX-A series and the external contact is long, it becomes easy for noise to influence the operation of the PMX-A series. Even if you use cables that are designed to suppress noise, the PMX-A series may not operate properly.

If you use a shielded cable, connect the shield to the negative output terminal.

Use pins 6 and 7 of the J1 connector.

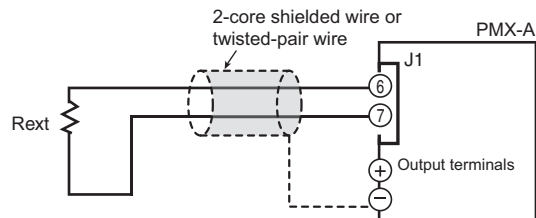

# Output Current Control

This section explains how to control the output current using an external voltage ( $V_{ext}$ ) or an external variable resistor of approximately 10 k $\Omega$  ( $R_{ext}$ ).

If the output current is being controlled, the panel display varies depending on the display status.

In setting display, the ammeter displays .

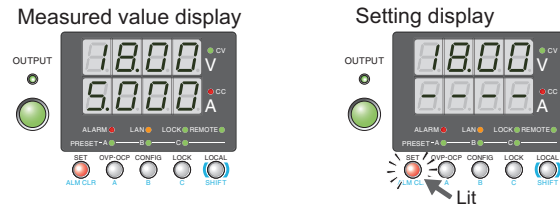

## Risk of electric shock.

- The insulation of  $V_{ext}$  or  $R_{ext}$  and the connected cable must be greater than or equal to the isolation voltage of the PMX-A series.  
For the isolation voltage of each model, “Specifications” on page 71.
- When using shielded cables for the connection, protect the uncovered sections of the shielded cable by using insulation tubes whose withstand voltage is greater than the PMX-A series’ isolation voltage.

## Control using an external voltage ( $V_{ext}$ )

 p. 36

To use an external voltage ( $V_{ext}$ ) to control the output current, set CC control using an external voltage or external resistance in the CONFIG settings to external voltage control (CF04: VoLt).

The output current ( $I_o$ ) varies in the range of 0 to the rated output current ( $I_{rtg}$ ) when the external voltage ( $V_{ext}$ ) is changed in the range of 0 V to 10 V.

$$\text{Output current } I_o = I_{rtg} \times V_{ext} / 10 \text{ [A]}$$

$I_{rtg}$ : Rated output current [A]

$V_{ext}$ : External voltage [V]



- The signal cable may burn out. Do not connect the  $V_{ext}$  output, that is, leave it floating. If you do, the PMX-A series may malfunction.
- Pay careful attention to the polarity of  $V_{ext}$ .
- Do not apply a voltage of 10.5 V or greater, or a reverse voltage across the external voltage control pins.

### External voltage (Vext) connection

Connect a low-noise, stable voltage source to Vext. The noise in Vext is multiplied by the amplification factor of the PMX-A series and appears in the output. Therefore, the output ripple noise may not meet the specifications of the PMX-A series.

To reduce the influence of noise on the output, connect a 2-core shielded wire or a twisted-pair wire across Vext, and keep the wire as short as possible. If the wiring between the PMX-A series and the external contact is long, it becomes easy for noise to influence the operation of the PMX-A series. Even if you use cables that are designed to suppress noise, the PMX-A series may not operate properly.

If you use a shielded cable, connect the shield to the negative output terminal. If the shield needs to be connected to the Vext side, see "Cautions when using the external voltage (Vext)".

Use pins 14 and 15 of the J1 connector.

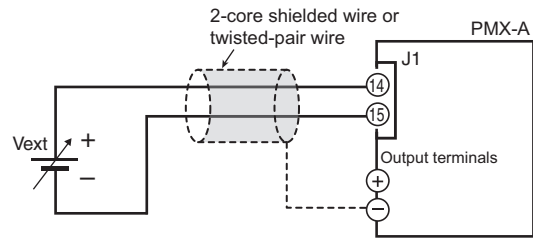

See p. 48

### Control using an external resistance (Rext)

See p. 36

By using an external resistance (Rext) to change the reference voltage's voltage-divider ratio, you can change the output current (Io) to a value in the range of 0 to the 100 % of the rated output current (Irtg).

To use an external resistance (Rext) to control the output current, set CC control using an external voltage or external resistance in the CONFIG settings to external resistance control (CF04: rES).

The output current (Io) varies in the range of 0 to the rated output current (Irtg) when the external resistance (Rext) is changed in the range of 0 Ω to 10 kΩ.

$$\text{Output current } I_o = I_{rtg} \times R_{ext} / 10 \text{ [A]}$$

Irtg: Rated output current [A]  
Rext: External resistance [kΩ]

### External resistance (Rext) connection

**NOTE**

Connect the external resistor securely. If the external resistor (Rext) becomes loose, an excessive voltage may be applied to the load.

For Rext, use a resistor that is rated at approximately 10 kΩ, 1/2 W or greater, that has a low temperature coefficient, and that will change little over time. Examples of such resistors are metal film or wire wound resistors.

To reduce the influence of noise on the output, connect a 2-core shielded wire or a twisted-pair wire across Rext, and keep the wire as short as possible. If the wiring is long, it becomes easy for noise to influence the operation of the PMX-A series. Even if you use wires that are designed to suppress noise, the PMX-A series may not operate properly.

If you use a shielded cable, connect the shield to the negative output terminal.

Use pins 16 and 17 of the J1 connector.

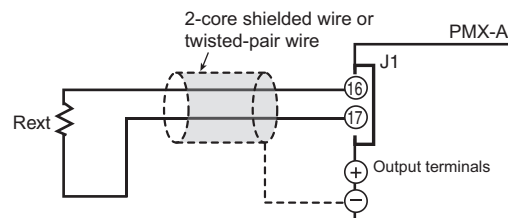

# Controlling the Output On and Off States

This section explains how to use an external contact to control the output on and off states.



## Risk of electric shock.

- The insulation of the external contact (S) and the connected cable must be greater than or equal to the isolation voltage of the PMX-A series. For the isolation voltage of each model, “Specifications” on page 71.
- When using shielded cables for the connection, protect the uncovered sections of the shielded cable by using insulation tubes whose withstand voltage is greater than the PMX-A series’ isolation voltage.

To reduce the influence of noise on the output, connect a 2-core shielded wire or a twisted-pair wire across the external contact, and keep the wire as short as possible. If the wiring is long, it becomes easy for noise to influence the operation of the PMX-A series. Even if you use cables that are designed to suppress noise, the PMX-A series may not operate properly. If you use a shielded cable, connect the shield to the negative output terminal.

To use an external contact to control the output on and off states, set the appropriate CONFIG parameter (CF06: on). Then, select the logic setting from the following two options.

- Turn the output on at the falling edge of the LOW signal (CF07: Lo)  
Output is turned on when a low (0 V to 0.5 V) signal is applied to pin 18 of the J1 connector or the pin is shorted.
- Turn the output on at the rising edge of the HIGH signal (CF07: Hi)  
Output is turned on when a high (4.5 V to 5 V) signal is applied to pin 18 of the J1 connector or the pin is opened.

Output on/off control is performed by detecting rising edges or falling edges. Because it is not a level detection, if you want to turn on the output at startup, you need to apply a signal so that an edge is detected.

Because output off is prioritized, if the output is turned off with an external contact, the OUTPUT key and OUTP command are disabled.

See p. 36

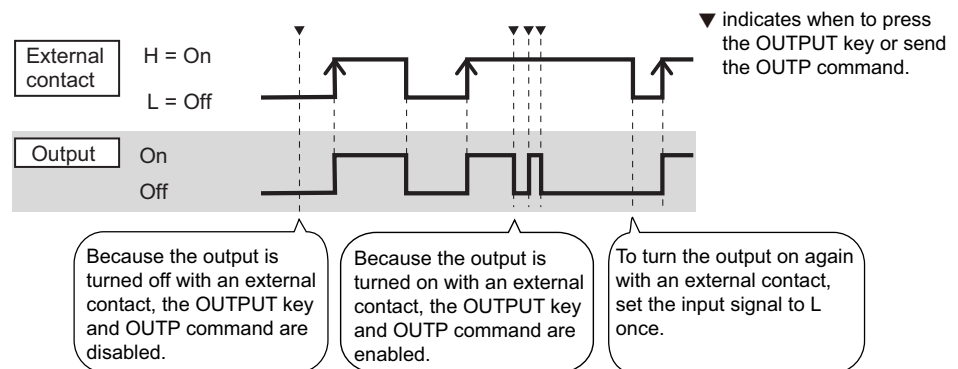

Controlling the output on and off states (in this example, a high signal is used to turn the output on)

### External contact connection

Use pins 18 and 19 of the J1 connector.

The open-circuit voltage across pins 18 and 19 is approximately 5 V. The short-circuit current across pins 18 and 19 is approximately 0.25 mA.

Use external contacts that have a contact rating greater than or equal to 0.25 mA at 5 Vdc.

If two or more units are floating, and you are using a single external contact to clear alarms, use a relay or similar device for the external contact signal to isolate the signal transmitted to each unit.

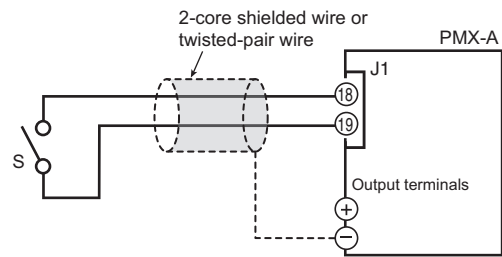

#### ■ For long-distance wiring

When you are wiring over a great distance, use a small relay and extend the coil side of the relay.

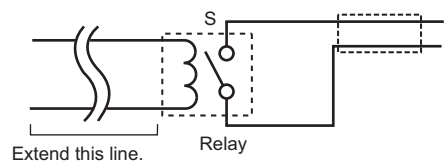

# External Monitoring

## External monitoring of the output voltage and output current

The J1 connector has monitor outputs for the output voltage and the output current.

Pin no.	Signal name	Description
1	VMON	Monitor output of output voltage 0 to approx. 10 V for 0 to rated output voltage
2	IMON	Monitor output of output current 0 to approx. 10 V for 0 to rated output current
3, 5, 15	ACOM	Remote control input common Output monitor common



Shorting VMON and IMON to ACOM may damage the PMX-A series.

### Monitor output rating

Output impedance: 1 k $\Omega$  or less, maximum output current: approx. 1 mA

The monitor output signals are used to monitor the DC voltage (mean value). They cannot be used to accurately monitor the AC components (such as ripple and transient response waveform) of the actual output voltage or current.

## External monitoring of the operation status

The J1 connector has status outputs that can be used to externally monitor the operation status of the PMX-A series. The following five items make up the status outputs.

The outputs are open collector outputs of photocouplers; they are isolated from the internal circuits of the PMX-A series.

The status common is floating (that is, it has an isolation voltage or less).

The maximum ratings of the signal terminals are as follows:

Maximum voltage 30 V, maximum current (sink) 8 mA

Pin no.	Signal name	Description	Circuit
25	STATUS COM	Status output common. Photocoupler emitter output.	
11	CV STATUS	This is set to low level when the PMX-A series is in constant voltage mode. Photocoupler open collector output.	
12	CC STATUS	This is set to low level when the PMX-A series is in constant current mode. Photocoupler open collector output.	
13	ALM STATUS	This is set to low level when a protection function is activated. Photocoupler open collector output.	
23	OUT ON STATUS	This is set to low level when the output is turned on. Photocoupler open collector output.	
24	PWR ON STATUS	This is set to low level when the POWER switch is turned on.	



This page has been intentionally left blank.







# 4

---

## Parallel/Series Operation

This chapter describes the functions of parallel operation and series operations as well as the connection, setup, and operation procedures.

# Parallel Operation

You can connect multiple PMX-As in parallel to increase the current capacity. You cannot perform master-slave series operation, which would enable you to control multiple slave units from a single master unit.

Specify the same output setting for the power supplies that are connected in parallel.



Otherwise, the PMX-A series may not operate properly. Use the same models for parallel operation.

## Parallel operation features

### Voltage display and current display

The voltage or current is displayed on each unit.

The voltmeter displays the voltage at the output terminals of each device.

To calculate the total output current, add the current values of each unit.

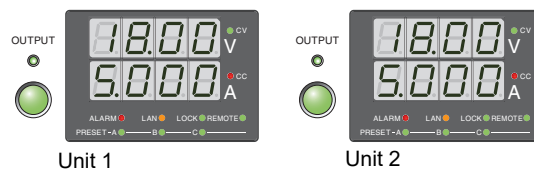

Example of the panel displays when two units operate in parallel



Do not connect the common wire (ACOM and DCOM) of each device together. If the load wire comes loose, the common wire may break.

### Remote sensing (only on models whose rated output voltage is 18 V or 35 V)

See p. 18

This is available.

### External control

See chapitre 3

This is available.

### External monitoring

See p. 55

- External monitoring of the output voltage (VMON)  
You can monitor the output voltage of each unit.
- External monitoring of the output current (IMON)  
You can monitor the output current of each unit. To determine the total output current, add the value displayed on the ammeter of each unit together.
- Status monitors  
You can monitor the status of the following items from each unit: constant-voltage mode (CV STATUS), constant-current mode (CC STATUS), output on (OUTON STATUS), POWER switch on (POWERON STATUS), and alarms (ALM STATUS).

## Alarm

The alarms that are detected on a single unit are also detected during parallel operation.

### ■ Clearing alarms

See p. 27

Press ALM CLR (SHIFT + SET) or turn off the POWER switch. Fix the problem that caused the alarm, and turn the POWER switch back on.

## Parallel operation connection

### Connecting the load



**WARNING** Risk of electric shock. Turn the POWER switch off before you touch the output terminals.



- When you connect the output terminals to the chassis terminals, be sure to connect the same polarity output terminals (positive or negative) to the chassis terminals. If you connect different polarity output terminals to the chassis terminal, the output will be grounded through the power cord's GND wire. Not only will this make the output incorrect, it will also cause the chassis terminal cable to burn out.
- To prevent oscillation, connect an electrolytic capacitor with a capacitance of a few hundred  $\mu\text{F}$  to a few ten thousand  $\mu\text{F}$  across the load as necessary. If the wires are long, the wiring inductance and capacitance can cause phase shifting at a level that can not be ignored. This may lead to oscillation. Use an electrolytic capacitor that has a withstand voltage that is at least 120 % of the rated output voltage.
- Twist the positive and negative cables together, and make the connection to the load as short as possible. Oscillation may occur as a result of wiring inductance.

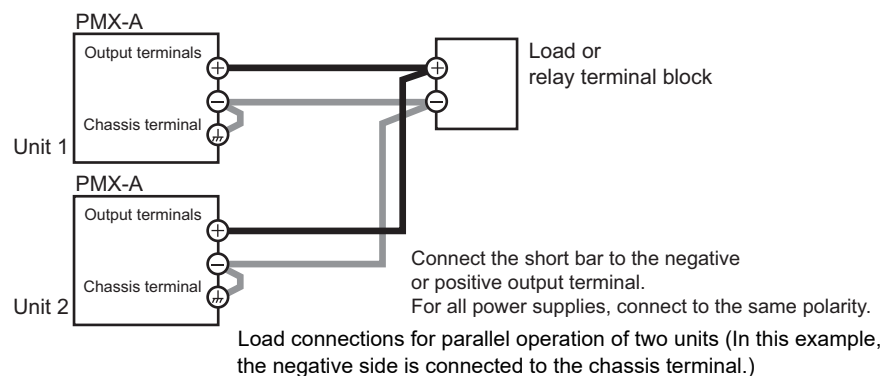

See p. 16

- 1 Turn off all the PMX-As that you want to connect in parallel.**
- 2 Connect the load cables to the output terminals of each unit.**
- 3 Connect the load cables of each unit to the load. If you are going to use a relay terminal block, make sure that the wires used to connect the units are as short as possible.**

Use load cables that have sufficient current capacity. Use load cables of equivalent length and cross-sectional area to connect to each unit, and wire the cables so that they are as short as possible.
- 4 Connect the output terminals (positive or negative) of the units you want to operate in parallel to the chassis terminals.**

Connect the same polarity output terminals on each unit.  
If you are using the units under floating conditions, do not connect the terminals.

## Parallel operation settings

---

### Setting the voltage and current

Set the voltage and current on each unit. The current that is output is the total of the currents of all the units.  
Set the voltage and current to the same values on each unit.

### Setting the overvoltage protection (OVP) and overcurrent protection (OCP)

See p. 28

You have to set the overvoltage protection (OVP) and overcurrent protection (OCP) on both units.  
Specify the same values on each unit.

## Starting parallel operation

---

### Turning the power on and off

Turn on or off the POWER switch of each unit.



**CAUTION** After you turn the POWER switch off, wait at least 10 seconds after the panel display turns off before you turn the POWER switch back on. Repeatedly turning the POWER switch on and off at short intervals, this will shorten the service life of the POWER switch, internal input fuse, and other components.

---

### Turning the output on and off

Turn on or off the OUTPUT switch of each unit.

# Series Operation

You can connect multiple PMX-As in series to increase the output voltage.

The number of units that can be connected in series depends on the output voltage and the isolation voltage of each unit. The total of the output voltages of the power supplies connected in series will be applied to the load.



## Risk of electric shock.

**Make sure that the maximum output voltage of the power supplies connected in series does not exceed the isolation voltage. Always observe the maximum number of units connected in series. For details on the isolation voltage of each model see the specifications.**

## Number of power supplies to connect in series

The number of units that can be connected in series depends on the output voltage and the isolation voltage of each model.

Example For the PMX18-5A, the isolation voltage is 70 V. The maximum number of units is determined as  $70/18 = 3.888$ , so up to 3 units can be connected.

## Series operation features

### Voltage display and current display

The voltage or current is displayed on each unit. To calculate the total output voltage, add the voltage values of each unit.



Unit 1



Unit 2

Example of the panel displays when two units operate in series

### Remote sensing

This is not available.

### External control

See chapter 3

This is available.



**Do not connect the common wire (ACOM and DCOM) of each device together. The common potential of each unit is different during series operation.**

## External monitoring



**WARNING** When monitoring is in progress, be careful of shorts and electric shocks. When monitoring the output voltage or output current during series operation, the electric potential of the common of each unit's monitor signal is different.

See p. 55

- External monitoring of the output voltage (VMON)  
You can monitor the output voltage of each unit.  
To calculate the total output voltage, add the monitored values of each unit.
- External monitoring of the output current (IMON)  
You can monitor the output current of each unit.
- Status monitors  
You can monitor the status of the following items from each unit: constant-voltage mode (CV STATUS), constant-current mode (CC STATUS), output on (OUTON STATUS), POWER switch on (POWERON STATUS), and alarms (ALM STATUS).

## Alarm

All the alarms that are detected on a single unit are also detected during series operation.

### ■ Clearing alarms

See p. 27

Press ALM CLR (SHIFT + SET) or turn off the POWER switch. Fix the problem that caused the alarm, and turn the POWER switch back on.

## Series operation connection

### Connecting the load



**WARNING** Risk of electric shock. Turn the POWER switch off before you touch the output terminals.



To prevent oscillation, connect an electrolytic capacitor with a capacitance of a few hundred  $\mu\text{F}$  to a few ten thousand  $\mu\text{F}$  across the load as necessary. If the wires are long, the wiring inductance and capacitance can cause phase shifting at a level that can not be ignored. This may lead to oscillation.

Use an electrolytic capacitor with a withstand voltage that is 120% or more of the total of the rated output voltages of the PMX-As that are connected in series.

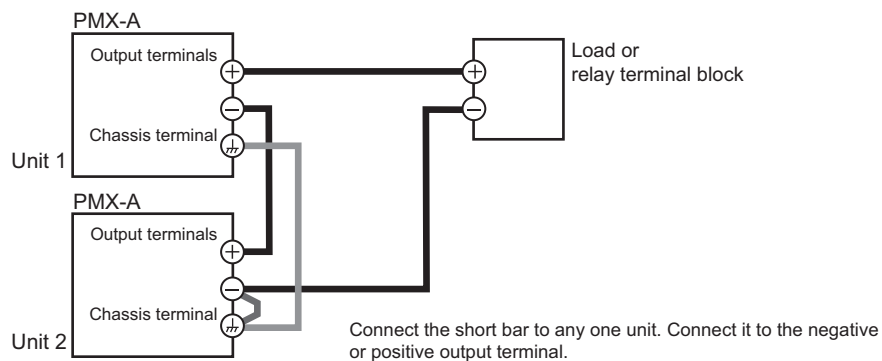

 p. 16

- 1 Turn off all the PMX-As that you want to connect in series.**
- 2 Use load cables to connect each unit to the load or relay terminal block.**  
Use load cables that have sufficient current capacity. Wire the load cables so that they are as short as possible. If the voltage drop in the load cable is large, the difference in electric potential between power supply units and the load regulation become large.
- 3 Connect the output terminals of each unit in series.**
- 4 Connect the positive or negative output terminal of one of the units to the chassis terminal with the short bar.**

## Series operation settings

### Setting the voltage and current

Set the voltage and current on each unit. The voltage that is output is the total of the voltages of all the units.  
Set the current to the same value on each unit.

### Setting the overvoltage protection (OVP) and overcurrent protection (OCP)

 p. 28

You have to set the overvoltage protection (OVP) and overcurrent protection (OCP) on both units.  
Specify the same values on each unit.

## Starting series operation

### Turning the power on and off

Turn on or off the POWER switch of each unit.



**CAUTION** After you turn the POWER switch off, wait at least 10 seconds after the panel display turns off before you turn the POWER switch back on. Repeatedly turning the POWER switch on and off at short intervals, this will shorten the service life of the POWER switch, internal input fuse, and other components.

### Turning the output on and off

Turn on or off the OUTPUT key of each unit.



This page has been intentionally left blank.







# 5

---

## Maintenance

This chapter explains how to perform calibration.

# Calibration

The product is calibrated before shipment. To maintain long-term performance, we recommend periodic calibration.

If you are going to calibrate the product, follow the procedure below.

## Calibration overview

The following 10 parameters can be calibrated.

Calibration is performed for 1 % and 100 % full scale.

- Output voltage offset (1 %)
- Voltmeter offset (1 %)
- Output current offset (1 %)
- Ammeter offset (1 %)
- Overvoltage protection (OVP)
- Output voltage full scale (100 %)
- Voltmeter full scale (100 %)
- Output current full scale (100 %)
- Ammeter full scale (100 %)
- Overcurrent protection (OCP)

### Required devices

- A DC voltmeter (DVM) with a measurement accuracy of 0.02 % or better
- A shunt resistor with an accuracy of 0.1 % or better, or an ammeter that can supply the rated output current of the PMX-A series to be calibrated

### Environment

Perform calibration in the following environment.

- Temperature:  $23\text{ °C} \pm 5\text{ °C}$
- Humidity: 80 %rh or less

To minimize the calibration error due to initial drift, warm up the PMX-A series for at least 30 minutes before calibration. In addition, warm up the DVM and shunt resistor for as long as is necessary.

## Calibration procedure



### Risk of electric shock.

- Turn the **POWER** switch off before you touch the output terminals.
- Be sure to connect the output terminal to the chassis terminal.

There are voltage system and current system calibration parameters.

During calibration, you can change the resolution.

While holding down LOCAL, turn the CURRENT knob to reduce the amount of change.

- 1 While holding down SET and LOCAL, turn the POWER switch on.**  
The calibration screen appears.
- 2 Turn the Voltage knob to select a calibration parameter.**  
Each time you turn the Voltage knob, the calibration parameter changes.
- 3 Press SET to save the calibration settings and end calibration. Press LOCK to not save the calibration settings and end calibration.**

### Calibration mode display

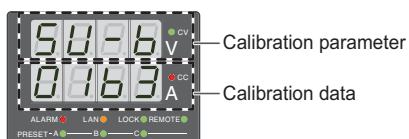

The voltmeter displays the calibration parameter, and the ammeter displays the calibration data.

The calibration parameters change in the following order.

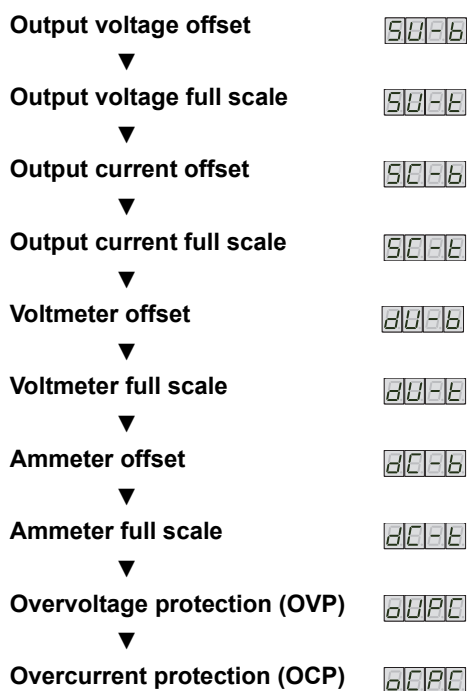

## Voltage system calibration

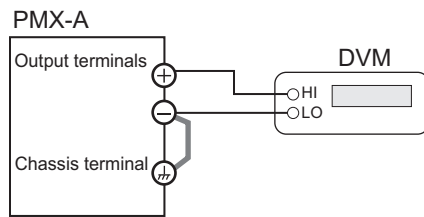

- 1** Turn the **POWER** switch off.
- 2** Connect a DVM to the output terminals.

### ■ Output voltage offset

Use the **VOLTAGE** knob to select the item, and turn on the output. Turn the **CURRENT** knob to set the DVM's output voltage reading to 1 % of the rated voltage.

### ■ Output voltage full scale

Use the **VOLTAGE** knob to select the item, and turn on the output. Turn the **CURRENT** knob to set the DVM's output voltage reading to 100 % of the rated voltage.

### ■ Voltmeter offset

Be sure to calibrate the output voltage before calibrating the voltmeter.

- 1** Use the **VOLTAGE** knob to select the item, and turn on the output.
- 2** Press **OVP•OCP**.
- 3** While viewing the **PMX-A** voltmeter, turn the **CURRENT** knob to match the **PMX-A** voltage reading to the **DVM** reading.

### ■ Voltmeter full scale

Be sure to calibrate the output voltage before calibrating the voltmeter.

- 1** Use the **VOLTAGE** knob to select the item, and turn on the output.
- 2** Press **OVP•OCP**.
- 3** Turn the **CURRENT** knob to match the **PMX-A** voltage reading to the **DVM** reading.

### ■ Overvoltage protection (OVP)

- 1** Use the **VOLTAGE** knob to select the item, and turn on the output.
- 2** Press **OVP•OCP**.  
The **OVP•OCP** key lights, and automatic calibration starts.
- 3** When the calibration is complete, the **OVP • OCP** key turns off.

#### NOTE

If you press **LOCK** during calibration (while the **SET** key is lit), the calibration will end without the calibration settings being saved.

## Current system calibration

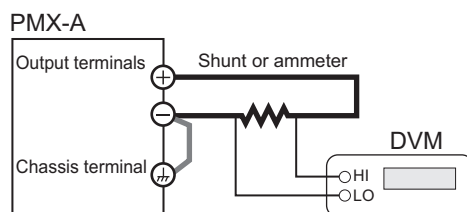

- 1 Turn the **POWER** switch off.
- 2 Connect a shunt to the output terminals, and connect a DVM across the shunt.

### ■ Output current offset

Use the **VOLTAGE** knob to select the item, and turn on the output. Turn the **CURRENT** knob to set the DVM's output current reading (converted current value) to 1 % of the rated current.

### ■ Output current full scale

Use the **VOLTAGE** knob to select the item, and turn on the output. Turn the **CURRENT** knob to set the DVM's output current reading (converted current value) to 100 % of the rated current.

### ■ Ammeter offset

Be sure to calibrate the output current before calibrating the ammeter.

- 1 Use the **VOLTAGE** knob to select the item, and turn on the output.
- 2 Press **OVP•OCP**.
- 3 While viewing the PMX-A ammeter, turn the **CURRENT** knob to match the PMX-A current reading to the DVM reading.

### ■ Ammeter full scale

Be sure to calibrate the output current before calibrating the ammeter.

- 1 Use the **VOLTAGE** knob to select the item, and turn on the output.
- 2 Press **OVP•OCP**.
- 3 Turn the **CURRENT** knob to match the PMX-A current reading to the DVM reading (converted current value).

### ■ Overcurrent protection (OCP)

- 1 Use the **VOLTAGE** knob to select the item, and turn on the output.
- 2 Press **OVP•OCP**.  
The OVP•OCP key lights, and automatic calibration starts.
- 3 When the calibration is complete, the **OVP • OCP** key turns off.

#### NOTE

If you press **LOCK** during calibration (while the **SET** key is lit), the calibration will end without the calibration settings being saved.



This page has been intentionally left blank.





# 6

---

## Specifications

This chapter describes the specifications and gives the dimensions of the PMX-A.

Unless specified otherwise, the specifications are for the following settings and conditions.

- Loads are pure resistive loads.
- The warm-up time is 30 minutes (with current flowing).
- Negative output is connected to the chassis terminal using the short bar.
- Values indicated by “TYP” are typical values. They are not guaranteed performance values.
- Values indicated by “rating” are rated values.
- Values indicated by “setting” are setting values.
- Values indicated by “reading” are readout values.
- Rated load and no load are defined as follows:

In constant-voltage mode (when the output current is set to a value greater than or equal to the maximum output current with rated output voltage)

**Rated load:** Refers to a resistive load that, when the rated output voltage is applied, makes the flowing current 95 % to 100 % of the maximum output current with rated output voltage.

**No load:** Refers to a load through which no output current flows. In other words, refers to an open load (no load being connected).

In constant-current mode (when the output voltage is set to a value greater than or equal to the maximum output voltage with rated output current)

**Rated load:** Refers to a resistive load that, when the rated output current flows, makes the voltage drop to 95 % to 100 % of the maximum output voltage with rated output current.

Including the voltage drop in the load cables, the PMX-A output voltage must not exceed the maximum output voltage with rated output current.

**No load:** Refers to a resistive load that, when the rated output current flows, makes the voltage drop to 10 % of the maximum output voltage with rated output current or 1 V whichever is higher.

## PMX18-2A/ PMX18-5A/ PMX35-1A/ PMX35-3A

### AC input

	PMX18-2A	PMX18-5A	PMX35-1A	PMX35-3A
Nominal input rating	100 Vac <sup>1</sup> , 50 Hz/ 60 Hz, single phase			
Input voltage range	± 10 %			
Input frequency range	47 Hz to 63 Hz			
Inrush current (MAX) <sup>2</sup>	50 Amax or less	60 Amax or less	45 Amax or less	60 Amax or less
Power (MAX) <sup>3</sup>	150 VA	310 VA	150 VA	310 VA

1 117 Vac, 200 Vac, 217 Vac and 234 Vac are factory options.

2 Excludes the charge current component that flows through the capacitor of the internal EMC filter circuit immediately after the POWER switch is turned on (for approximately 1 ms).

3 With the rated load.



## Output

		PMX18-2A	PMX18-5A	PMX35-1A	PMX35-3A	
Rating	Output voltage	18.00 V	18.00 V	35.00 V	35.00 V	
	Output current	2.000 A	5.000 A	1.000 A	3.000 A	
	Output power	36 W	90 W	35 W	105 W	
Voltage	Setting range	0 V to 18.90 V	0 V to 18.90 V	0 V to 36.75 V	0 V to 36.75 V	
	Setting resolution <sup>1</sup>	1 mV				
	Setting accuracy	±(0.2 % of setting + 0.1 % of rating)				
	Line regulation <sup>2</sup>	±1 mV	±1 mV	±3 mV	±3 mV	
	Load regulation <sup>3</sup>	±2 mV	±5 mV	±3 mV	±4 mV	
	Transient response <sup>4</sup>	50 μs				
	Ripple noise	(rms) <sup>5</sup>	0.5 mV			
	Rise time <sup>6</sup>	Rated load	120 ms or less			
		No load	120 ms or less			
	Fall time <sup>7</sup>	Rated load	50 ms or less			
		No load	270 ms or less	320 ms or less	270 ms or less	270 ms or less
	Maximum remote sensing compensation voltage (single line)	0.6 V				
	Temperature coefficient (MAX)	100 ppm/ °C				
	Current	Setting range	0 A to 2.1 A	0 A to 5.25 A	0 A to 1.05 A	0 A to 3.15 A
Setting resolution <sup>1</sup>		0.1 mA				
Setting accuracy		±(0.3 % of setting + 0.1 % of rating)				
Line regulation		±5 mA				
Load regulation		±5 mA				
Ripple noise		(rms) <sup>5</sup>	1 mA	2 mA	1 mA	1 mA
Temperature coefficient (TYP)		200 ppm/°C				

- When the output is on, hold down SHIFT and turn the VOLTAGE or CURRENT knob to change the value at 1/10th the resolution of the minimum digit.  
When the output is off, hold down SHIFT and turn the VOLTAGE or CURRENT knob to change the value at increments of 1 in the minimum digit.  
If you are setting the value through the communication interface, you can set the value at 1/10th the resolution of the minimum digit, regardless of whether the output is on.
- 100 Vac to 90 Vac or 100 Vac to 110 Vac, rated load.
- The amount of change that occurs when the load is changed from no load to rated load with rated output voltage.  
The value is measured at the sensing point.
- The amount of time required for the output voltage to return to a value within "rated output voltage ±(0.05 % + 10 mV)." When the load current is changed from 10 % to 100 % of the rated output current.
- When the measurement frequency bandwidth is 5 Hz to 1 MHz.
- The time it takes for the output voltage to rise from 10 % to 90 % of the rating when the output is turned on.
- The time it takes for the output voltage to fall from 90 % to 10 % of the rating when the output is turned off.

## Display function

		PMX18-2A	PMX18-5A	PMX35-1A	PMX35-3A
Voltage display	Maximum display	99.99 (fixed decimal point)			
	Display accuracy <sup>1</sup>	±(0.5 % of reading + 2 digits)			
Current display	Maximum display	9.999 (fixed decimal point)			
	Display accuracy <sup>1</sup>	±(1 % of reading + 5 digits)			
Operation display	OUTPUT ON/OFF	Output on: OUTPUT LED lights in green. Output off: OUTPUT LED turns off.			
	CV operation	CV LED lights in green.			
	CC operation	CC LED lights in red.			
	Alarm operation	ALARM LED lights in red when a protection function has been activated.			
	Remote operation	REMOTE LED lights in green during remote control.			
	LAN operation	LAN LED lights or blinks depending on the LAN communication status. No fault status: Lights in green. Fault status: Lights in red. Standby status: Lights in orange. WEB identify status: Blinks green.			
	Key lock operation	LOCK LED lights in green when the keys are locked.			
Preset memory	When a preset memory entry is being used, the PRESET A, B, or C LED lights in green.				

<sup>1</sup> Ambient temperature at 23 °C ±5 °C.

## Protection functions

		PMX18-2A	PMX18-5A	PMX35-1A	PMX35-3A
Overvoltage protection (OVP)	Operation	Turns the output off, displays OVP, and lights ALARM			
	Setting range	1.8 V to 19.8 V	1.8 V to 19.8 V	3.5 V to 38.5 V	3.5 V to 38.5 V
	Setting accuracy	±(1 % of rating)			
Overcurrent protection (OCP)	Operation <sup>1</sup>	Turns the output off, displays OCP, and lights ALARM			
	Setting range	0.2 A to 2.2 A	0.5 A to 5.5 A	0.1 A to 1.1 A	0.3 A to 3.3 A
	Setting range	±(1 % of rating)			
Overheat protection (OHP)	Operation	Turns the output off, displays OHP, and lights ALARM			

<sup>1</sup> This does not protect against the discharge current peak that is generated from the capacitors inside the PMX-A output section when the load is changed suddenly.

## Signal output

			Common specifications
Monitor signal output <sup>1 2</sup>	Voltage monitor (VMON)	At rated voltage output	10.00 V ±0.1 V
		At 0 V output	0.00 V ±0.1 V
	Current monitor (IMON)	At rated current output	10.00 V ±0.1 V
		At 0 A output	0.00 V ±0.1 V
Status signal output <sup>2 3</sup>	OUTON STATUS		Turns on when the output is on
	CV STATUS		Turns on during CV operation
	CC STATUS		Turns on during CC operation
	ALM STATUS		Turns on when an alarm has been activated
	PWR ON STATUS		Turns on when the power is turned on

- 1 When remote sensing is used, connect the monitor signal's common line to the negative S terminal of the sensing terminal. When remote sensing is not used, connect it to the negative output terminal.
- 2 J1 connector on the rear panel
- 3 Photocoupler open collector output; maximum voltage 30 V, maximum current (sink) 8 mA; isolated from the output and control circuits; status commons are floating (isolation voltage or less); and status signals are not mutually isolated.

## Control features

			Common specifications
External control <sup>1</sup>	EXT-V CV CONT (CV external voltage control)		0 % to 100 % of the rated output voltage in the range of 0 V to 10 V.
		Accuracy	1 % of rating +10 mV
	EXT-R CV CONT (CV external resistance control)		0 % to 100 % of the rated output voltage in the range of 0 Ω to 10 kΩ.
		Accurac	1 % of rating +10 mV
	EXT-V CC CONT (CC external voltage control)		0 % to 100 % of the rated output current in the range of 0 V to 10 V
		Accuracy	1 % of rating +5 mV
	EXT-R CC CONT (CC external resistance control)		0 % to 100 % of the rated output current in the range of 0 Ω to 10 kΩ.
		Accurac	1 % of rating +5 mV
	OUTPUT ON/OFF CONT (Output on/off control)		Possible logic selections: Turn the output on using a LOW (0 V to 0.5 V) or short-circuit, turn the output off using a HIGH (4.5 V to 5 V) or open-circuit. Turn the output on using a HIGH (4.5 V to 5 V) or open-circuit, turn the output off using a LOW (0 V to 0.5 V) or short-circuit.

- 1 J1 connector on the rear panel

## Other features

		Common specifications
Preset memory	Up to three sets of the following settings can be saved: the set voltage and the set current.	
Key lock	Select from the following three modes. Loc1: Locks the operation of all keys except the OUTPUT key and the preset memory A, B, and C keys. Loc2: Locks the operation of all keys except than the OUTPUT key. Loc3: Locks the operation of all keys and the rotary knob.	

## Interface

		Common specifications
Common specifications	Software protocol	IEEE Std 488.2-1992
	Command language	Complies with SCPI Specification 1999.0
RS232C	Hardware	Complies with the EIA232D specifications
		D-SUB9 pin connector (male) <sup>1</sup>
		Baud rate: 19200 bps fixed
		Data length: 8 bits, Stop bits: 1 bit, Parity bit: None
	Program message terminator	LF during reception, LF during transmission
USB	Hardware	Complies with the USB 2.0 specifications. Baud rate:12 Mbps (full speed).
		Socket B Type
	Program message terminator	LF or EOM during reception, LF + EOM during transmission
LAN	Hardware	Complies with the USBTMC-USB488 device class specifications
		Complies with the IEEE 802.3 100Base-TX/10Base-T Ethernet Complies with the LXI 1.4 Core 2011
	Communication protocol	IPv4, RJ-45 connector <sup>2</sup> VXI-11, HiSLIP, or SCPI-RAW
	Program message terminator	VXI-11 and HiSLIP:LF or END during reception, LF + END during transmission SCPI-RAW:LF during reception, LF during transmission

- 1 Use a cross cable (null modem cable).
- 2 Category 5; use a straight cable.

## General specifications

		PMX18-2A	PMX18-5A	PMX35-1A	PMX35-3A
Weight (main unit only)		Approximately 5 kg (11.02 lb)	Approximately 6 kg (13.23 lb)	Approximately 5 kg (11.02 lb)	Approximately 6 kg (13.23 lb)
Dimensions		See the outline drawing			
Environmental conditions	Operating environment	Indoor use, overvoltage category II			
	Operating temperature	0 °C to +40 °C (32 °F to +104 °F)			
	Operating humidity	20 %rh to 85 %rh (no condensation)			
	Storage temperature	-25 °C to +70 °C (-13 °F to +158 °F)			
	Storage humidity	90 %rh or less (no condensation)			
	Altitude	Up to 2000 m			
Cooling method		Forced air cooling using fan			
Grounding polarity		Negative grounding or positive grounding possible			
Isolation voltage		±70 Vdc			
Withstand voltage	Between input and FG	No abnormalities at 1500 Vac for 1 minute			
	Between input and output	No abnormalities at 2100 Vac for 1 minute			
	Between output and FG	No abnormalities at 1600 Vdc for 1 minute			
Insulation resistance	Between input and FG	500 Vdc, 30 MΩ or more			
	Between input and output	500 Vdc, 30 MΩ or more			
	Between input and output	500 Vdc, 30 MΩ or more			
Electromagnetic compatibility <sup>1 2</sup>		Complies with the requirements of the following directive and standards. EMC Directive 2014/30/EU EN 61326-1 (Class A <sup>3</sup> ) EN 55011 (Class A <sup>3</sup> , Group 1 <sup>4</sup> ) EN 61000-3-2 EN 61000-3-3  Applicable under the following conditions The maximum length of all cabling and wiring connected to the PMX-A must be less than 3 m.			
Safety <sup>1</sup>		Complies with the requirements of the following directive and standard. Low Voltage Directive 2014/35/EU <sup>2</sup> EN 61010-1 (Class I <sup>5</sup> , Pollution degree 2 <sup>6</sup> )			
Accessories	Power cord	1 pc.			
	Packing list	1 copy			
	Quick reference	Japanese:1 copy, English:1 copy, Chinese:1 copy			
	Safety precautions	1 copy			
	CD-ROM	1 disc			

- 1 Does not apply to specially ordered or modified PMX-As.
- 2 Limited to products that have the CE mark on their panels.  
CE mark does not apply unless you use a USB cable with a ferrite core.[Kikusui-recommended cable: Elecom U2C-BF series USB cable with a ferrite core, less than 3 m]
- 3 This is a Class A equipment. The PMX-A is intended for use in an industrial environment. This product may cause interference if used in residential areas. Such use must be avoided unless the user takes special measures to reduce electromagnetic emissions to prevent interference to the reception of radio and television broadcasts.
- 4 This is a Group 1 equipment. The PMX-A does not generate and/or use intentionally radio-frequency energy, in the form of electromagnetic radiation, inductive and/or capacitive coupling, for the treatment of material or inspection/analysis purpose.
- 5 This is a Class I equipment. Be sure to ground the PMX-A's protective conductor terminal. The safety of this product is only guaranteed when the product is properly grounded.
- 6 Pollution is addition of foreign matter (solid, liquid or gaseous) that may produce a reduction of dielectric strength or surface resistivity. Pollution Degree 2 assumes that only non-conductive pollution will occur except for an occasional temporary conductivity caused by condensation.

## PMX70-1A/ PMX110-0.6A/ PMX250-0.25A/ PMX350-0.2A/ PMX500-0.1A

### AC input

	PMX70-1A	PMX110-0.6A	PMX250-0.25A	PMX350-0.2A	PMX500-0.1A
Nominal input rating	100 Vac <sup>1</sup> , 50 Hz/ 60 Hz, single phase				
Input voltage range	± 10 %				
Input frequency range	47 Hz to 63 Hz				
Inrush current (MAX) <sup>2</sup>	65 Amax or less	55 Amax or less	40 Amax or less	55 Amax or less	40 Amax or less
Power (MAX) <sup>3</sup>	230 VA	210 VA	210 VA	230 VA	170 VA

- 1 117 Vac, 200 Vac, 217 Vac and 234 Vac are factory options.
- 2 Excludes the charge current component that flows through the capacitor of the internal EMC filter circuit immediately after the POWER switch is turned on (for approximately 1 ms).
- 3 With the rated load.

## Output

		PMX70-1A	PMX110-0.6A	PMX250-0.25A	PMX350-0.2A	PMX500-0.1A	
Rating	Output voltage	70.00 V	110.0 V	250.0 V	350.0 V	500.0 V	
	Output current	1.000 A	0.600 A	0.250 A	0.200 A	0.100 A	
	Output power	70 W	66 W	62.5 W	70 W	50 W	
Voltage	Setting range	0 V to 73.5 V	0 V to 115.5 V	0 V to 262.5 V	0 V to 367.5 V	0 V to 525.0 V	
	Setting resolution <sup>1</sup>	2 mV	10 mV				
	Setting accuracy	±(0.2 % of setting + 0.1 % of rating)					
	Line regulation <sup>2</sup>	±5 mV	±7 mV	±15 mV	±25 mV	±30 mV	
	Load regulation <sup>3</sup>	±5 mV	±7 mV	±15 mV	±25 mV	±30 mV	
	Transient response <sup>4</sup>	100 μs					
	Ripple noise	(rms) <sup>5</sup>	1 mV	2 mV	3 mV	5 mV	10 mV
	Rise time <sup>6</sup>	Rated load	150 ms or less	120 ms or less	120 ms or less	150 ms or less	120 ms or less
		No load	150 ms or less	120 ms or less	120 ms or less	150 ms or less	120 ms or less
	Fall time <sup>7</sup>	Rated load	50 ms or less	50 ms or less	50 ms or less	80 ms or less	50 ms or less
		No load	270 ms or less	120 ms or less <sup>8</sup>	120 ms or less <sup>8</sup>	220 ms or less	60 ms or less
	Maximum remote sensing compensation voltage (single line) <sup>9</sup>	--					
	Temperature coefficient (MAX)	100 ppm/ °C					
Current	Setting range	0 A to 1.050 A	0 A to 0.630 A	0 A to 0.262 A	0 A to 0.210 A	0 A to 0.105 A	
	Setting resolution <sup>1</sup>	0.1 mA					
	Setting accuracy	±(0.3 % of setting + 0.1 % of rating)					
	Line regulation	±2 mA	±2 mA	±1 mA	±1 mA	±1 mA	
	Load regulation	±5 mA	±5 mA	±5 mA	±5 mA	±3 mA	
	Ripple noise	(rms) <sup>5</sup>	1 mA				
	Temperature coefficient (TYP)	200 ppm/°C					

- 1 When the output is on, hold down SHIFT and turn the VOLTAGE or CURRENT knob to change the value at 1/10th the resolution of the minimum digit. However, when you set the voltage on the PMX70-1A, the value changes at 1/5th the resolution of the minimum digit.  
When the output is off, hold down SHIFT and turn the VOLTAGE or CURRENT knob to change the value at increments of 1 in the minimum digit.  
If you are setting the value through the communication interface, you can set the value at 1/10th the resolution of the minimum digit, regardless of whether the output is on.
- 2 100 Vac to 90 Vac or 100 Vac to 110 Vac, rated load.
- 3 The amount of change that occurs when the load is changed from no load to rated load with rated output voltage. The value is measured at the sensing point.
- 4 The amount of time required for the output voltage to return to a value within "rated output voltage ±(0.05 % + 10 mV)."  
When the load current is changed from 10 % to 100 % of the rated output current.
- 5 When the measurement frequency bandwidth is 5 Hz to 1 MHz.
- 6 The time it takes for the output voltage to rise from 10 % to 90 % of the rating when the output is turned on.
- 7 The time it takes for the output voltage to fall from 90 % to 10 % of the rating when the output is turned off.
- 8 At the rated output voltage. The fall time increases at voltages less than the rated output voltage.
- 9 The remote sensing function is not available.

## Display function

		PMX70-1A	PMX110-0.6A	PMX250-0.25A	PMX350-0.2A	PMX500-0.1A
Voltage display	Maximum display	99.99 (fixed decimal point)	999.9 (fixed decimal point)			
	Display accuracy <sup>1</sup>	±(0.5 % of reading + 2 digits)				
Current display	Maximum display	9.999 (fixed decimal point)				
	Display accuracy <sup>1</sup>	±(1 % of reading + 5 digits)				
Operation display	OUTPUT ON/OFF	Output on: OUTPUT LED lights in green. Output off: OUTPUT LED turns off.				
	CV operation	CV LED lights in green.				
	CC operation	CC LED lights in red.				
	Alarm operation	ALARM LED lights in red when a protection function has been activated.				
	Remote operation	REMOTE LED lights in green during remote control.				
	LAN operation	LAN LED lights or blinks depending on the LAN communication status. No fault status: Lights in green. Fault status: Lights in red. Standby status: Lights in orange. WEB identify status: Blinks green.				
	Key lock operation	LOCK LED lights in green when the keys are locked.				
	Preset memory	When a preset memory entry is being used, the PRESET A, B, or C LED lights in green.				

<sup>1</sup> Ambient temperature at 23 °C ±5 °C.

## Protection functions

		PMX70-1A	PMX110-0.6A	PMX250-0.25A	PMX350-0.2A	PMX500-0.1A
Overvoltage protection (OVP)	Operation	Turns the output off, displays OVP, and lights ALARM				
	Setting range	7 V to 77.00 V	11 V to 121.0 V	25 V to 275.0 V	35 V to 385.0 V	50 V to 550.0 V
	Setting accuracy	±(1 % of rating)				
Overcurrent protection (OCP)	Operation <sup>1</sup>	Turns the output off, displays OCP, and lights ALARM				
	Setting range	0.100 A to 1.100 A	0.060 A to 0.660 A	0.025 A to 0.275 A	0.020 A to 0.220 A	0.010 A to 0.110 A
	Setting range	±(1 % of rating)				
Overheat protection (OHP)	Operation	Turns the output off, displays OHP, and lights ALARM				

<sup>1</sup> This does not protect against the discharge current peak that is generated from the capacitors inside the PMX-A output section when the load is changed suddenly.



## Signal output

			Common specifications
Monitor signal output <sup>1 2</sup>	Voltage monitor (VMON)	At rated voltage output	10.00 V ±0.1 V
		At 0 V output	0.00 V ±0.1 V
	Current monitor (IMON)	At rated current output	10.00 V ±0.1 V
		At 0 A output	0.00 V ±0.1 V
Status signal output <sup>2 3</sup>	OUTON STATUS		Turns on when the output is on
	CV STATUS		Turns on during CV operation
	CC STATUS		Turns on during CC operation
	ALM STATUS		Turns on when an alarm has been activated
	PWR ON STATUS		Turns on when the power is turned on

- 1 When remote sensing is used, connect the monitor signal's common line to the negative S terminal of the sensing terminal. When remote sensing is not used, connect it to the negative output terminal.
- 2 J1 connector on the rear panel
- 3 Photocoupler open collector output; maximum voltage 30 V, maximum current (sink) 8 mA; isolated from the output and control circuits; status commons are floating (isolation voltage or less); and status signals are not mutually isolated.

## Control features

			Common specifications
External control <sup>1</sup>	EXT-V CV CONT (CV external voltage control)		0 % to 100 % of the rated output voltage in the range of 0 V to 10 V.
		Accuracy	1 % of rating
	EXT-R CV CONT (CV external resistance control)		0 % to 100 % of the rated output voltage in the range of 0 Ω to 10 kΩ.
		Accurac	1 % of rating
	EXT-V CC CONT (CC external voltage control)		0 % to 100 % of the rated output current in the range of 0 V to 10 V
		Accuracy	1 % of rating
	EXT-R CC CONT (CC external resistance control)		0 % to 100 % of the rated output current in the range of 0 Ω to 10 kΩ.
		Accurac	1 % of rating
	OUTPUT ON/OFF CONT (Output on/off control)		Possible logic selections: Turn the output on using a LOW (0 V to 0.5 V) or short-circuit, turn the output off using a HIGH (4.5 V to 5 V) or open-circuit. Turn the output on using a HIGH (4.5 V to 5 V) or open-circuit, turn the output off using a LOW (0 V to 0.5 V) or short-circuit.

- 1 J1 connector on the rear panel

## Other features

		Common specifications
Preset memory	Up to three sets of the following settings can be saved: the set voltage and the set current.	
Key lock	Select from the following three modes. Loc1: Locks the operation of all keys except the OUTPUT key and the preset memory A, B, and C keys. Loc2: Locks the operation of all keys except than the OUTPUT key. Loc3: Locks the operation of all keys and the rotary knob.	

## Interface

		Common specifications
Common specifications	Software protocol	IEEE Std 488.2-1992
	Command language	Complies with SCPI Specification 1999.0
RS232C	Hardware	Complies with the EIA232D specifications
		D-SUB9 pin connector (male) <sup>1</sup>
		Baud rate: 19200 bps fixed
		Data length: 8 bits, Stop bits: 1 bit, Parity bit: None
	Program message terminator	LF during reception, LF during transmission
USB	Hardware	Complies with the USB 2.0 specifications. Baud rate:12 Mbps (full speed).
		Standard Type B socket
	Program message terminator	LF or EOM during reception, LF + EOM during transmission
LAN	Hardware	Complies with the USBTMC-USB488 device class specifications
		Complies with the IEEE 802.3 100Base-TX/10Base-T Ethernet Complies with the LXI 1.4 Core 2011
	Communication protocol	IPv4, RJ-45 connector <sup>2</sup> VXI-11, HiSLIP, or SCPI-RAW
	Program message terminator	VXI-11 and HiSLIP:LF or END during reception, LF + END during transmission SCPI-RAW:LF during reception, LF during transmission

- 1 Use a cross cable (null modem cable).
- 2 Category 5; use a straight cable.

## General specifications

		PMX70-1A	PMX110-0.6A	PMX250-0.25A	PMX350-0.2A	PMX500-0.1A
Weight (main unit only)		Approximately 6 kg (13.23 lb)				
Dimensions		See the outline drawing				
Environmental conditions	Operating environment	Indoor use, overvoltage category II				
	Operating temperature	0 °C to +40 °C (32 °F to +104 °F)				
	Operating humidity	20 %rh to 85 %rh (no condensation)				
	Storage temperature	-25 °C to +70 °C (-13 °F to +158 °F)				
	Storage humidity	90 %rh or less (no condensation)				
	Altitude	Up to 2000 m				
Cooling method		Forced air cooling using fan				
Grounding polarity		Negative grounding or positive grounding possible				
Isolation voltage		±550 Vdc				
Withstand voltage	Between input and FG	No abnormalities at 1500 Vac for 1 minute				
	Between input and output	No abnormalities at 2100 Vac for 1 minute				
	Between output and FG	No abnormalities at 2000 Vdc for 1 minute				
Insulation resistance	Between input and FG	1000 Vdc, 30 MΩ or more				
	Between input and output	1000 Vdc, 30 MΩ or more				
	Between input and output	1000 Vdc, 30 MΩ or more				
Electromagnetic compatibility <sup>1 2</sup>		Complies with the requirements of the following directive and standards. EMC Directive 2014/30/EU EN 61326-1 (Class A <sup>3</sup> ) EN 55011 (Class A <sup>3</sup> , Group 1 <sup>4</sup> ) EN 61000-3-2 EN 61000-3-3  Applicable under the following conditions The maximum length of all cabling and wiring connected to the PMX-A must be less than 3 m.				
Safety <sup>1</sup>		Complies with the requirements of the following directive and standard. Low Voltage Directive 2014/35/EU <sup>2</sup> EN 61010-1 (Class I <sup>5</sup> , Pollution degree 2 <sup>6</sup> )				
Accessories	Power cord	1 pc.				
	Packing list	1 copy				
	Quick reference	Japanese:1 copy, English:1 copy, Chinese:1 copy				
	Safety precautions	1 copy				
	CD-ROM	1 disc				

<sup>1</sup> Does not apply to specially ordered or modified PMX-As.

<sup>2</sup> Limited to products that have the CE mark on their panels.

CE mark does not apply unless you use a USB cable with a ferrite core. [Kikusui-recommended cable: Elecom U2C-BF series USB cable with a ferrite core, less than 3 m]

<sup>3</sup> This is a Class A equipment. The PMX-A is intended for use in an industrial environment. This product may cause interference if used in residential areas. Such use must be avoided unless the user takes special measures to reduce electromagnetic emissions to prevent interference to the reception of radio and television broadcasts.

<sup>4</sup> This is a Group 1 equipment. The PMX-A does not generate and/or use intentionally radio-frequency energy, in the form of electromagnetic radiation, inductive and/or capacitive coupling, for the treatment of material or inspection/analysis purpose.

<sup>5</sup> This is a Class I equipment. Be sure to ground the PMX-A's protective conductor terminal. The safety of this product is only guaranteed when the product is properly grounded.

<sup>6</sup> Pollution is addition of foreign matter (solid, liquid or gaseous) that may produce a reduction of dielectric strength or surface resistivity. Pollution Degree 2 assumes that only non-conductive pollution will occur except for an occasional temporary conductivity caused by condensation.

## Dimensions

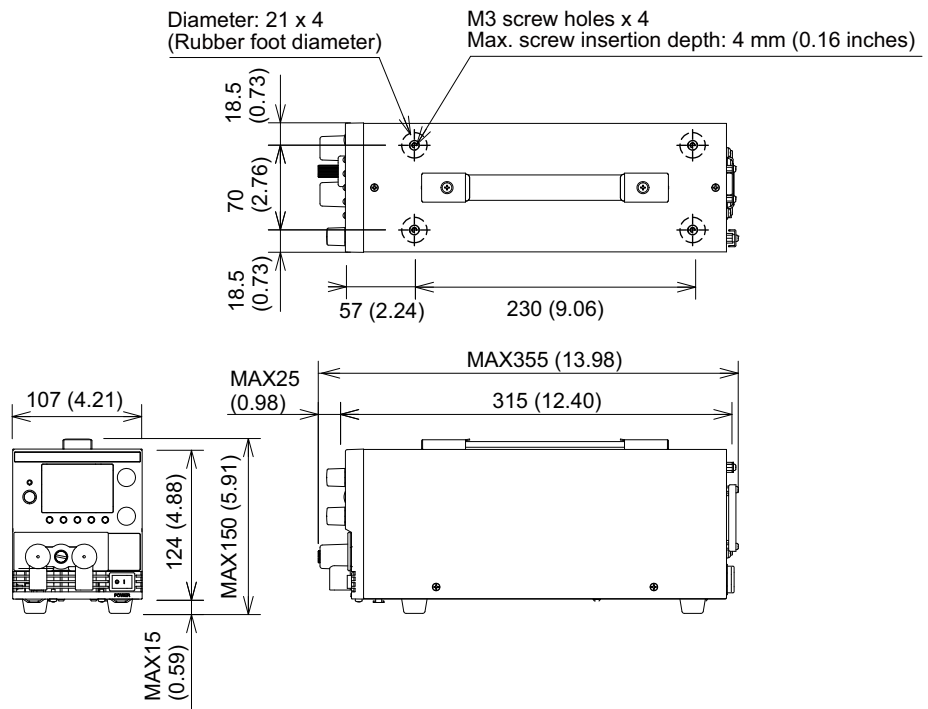

PMX-A series outline drawing

Unit: mm (inch)



# Appendix

---

A Options

B Troubleshooting

# A Options

The PMX-A series has the following options.

For information about options, contact your Kikusui agent or distributor.

## Rack mount option

Name	Model	Note
Rack mount adapter	KRA3	For EIA inch racks
	KRA150	For JIS millimeter racks
Blank panel	KBP3-2 (1/2 width)	For both EIA inch racks and JIS millimeter racks
	KBP3-4 (1/4 width)	
	BP191 (-M) <sup>1</sup>	For EIA inch racks
	BP1H (-M) <sup>1</sup>	For JIS millimeter racks

1 The “-M” at the end of the model name indicates a mesh type.

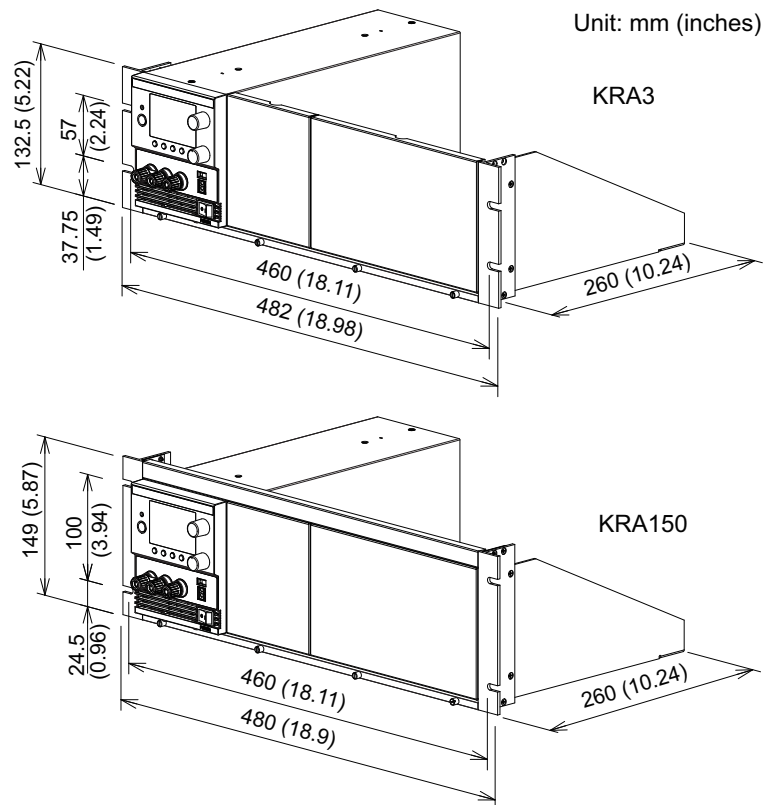

Remove the handle and rubber feet before you mount the PMX-A to a rack.

For information on rack mounting, see the KRA3 or KRA150 operation manual.

To support the main unit, attach an angle support to it that is appropriate for the rack.

We recommend that you keep all pieces that you have removed from the PMX-A. You will need these pieces if you remove the PMX-A from the rack.

If you remove the PMX-A from the rack, re-attach the original rubber feet.

**NOTE**

To reinstall the handle that has been removed, use screw locking agent (e.g., 1401B by ThreeBond International, Inc.) to prevent screws from loosening..

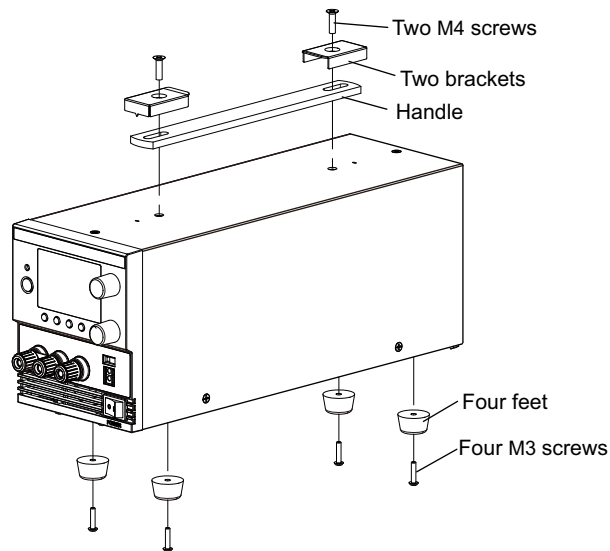
**■ Removing the handle and feet**

- 1** Unfasten the two M4 screws, and remove the entire handle.
- 2** Unfasten the four M3 screws, and remove the four rubber feet.

See p.44

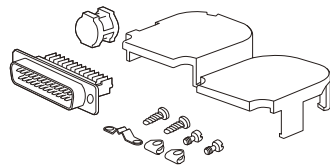
**Connector kit OP01-PMX (749809-9 DB25)**

A connector kit for connecting to the J1 connector to externally control the PMX-A.

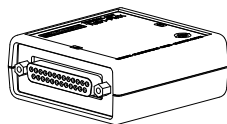
**Terminal unit TU01-PMX**

A terminal unit for converting the J1 connector of this product to the J2 connector of the Kikusui PMC-A Series Regulated DC Power Supply.

**App**

# B Troubleshooting

This section introduces troubleshooting measures. Typical symptoms are listed. Check whether any of the items listed below apply to your case. In some cases, the problem can be solved quite easily.

 p.42

If none of the items apply to your case, we recommend that you initialize the PMX-A series to its factory default settings. If the remedy does not correct the problem, contact your Kikusui agent or distributor..

## The power does not turn on

Symptom	Items to check	Remedy	
The PMX-A series does not operate when the POWER switch is turned on.	Is the power cord broken?	Exchange the power cord with a new one.	p.10
	Is the power cord connected correctly? <table border="0" style="display: inline-table; vertical-align: middle;"><tr><td style="padding-right: 10px;">Yes</td></tr><tr><td>No</td></tr></table>	Yes	
Yes			
No			
When the POWER switch is turned on, it takes time before the operation-ready screen appears.	Is the PMX-A series configured to use a DHCP server for the LAN interface?	If a DHCP server is not available or if the network environment is not in good condition, it may take time for the PMX-A series to start. Configure the PMX-A series to not use a DHCP server in the CONFIG settings (CF30: oFF), or consult your network administrator.	p.37

## No output is generated

Symptom	Items to check	Remedy			
No output is generated even when the OUTPUT switch is turned on.	Is the output voltage set to 0 V and the output current set to 0 A?	Turn the knobs to set the output voltage and output current to the required values.	p.23		
	Are you using an external contact to turn output on and off? <table border="0" style="display: inline-table; vertical-align: middle;"><tr><td style="padding-right: 10px;">Yes</td></tr><tr><td>No</td></tr></table>	Yes	No	Use the external contact to turn output on.	p.53
	Yes				
No					
	Set the external control parameter for turning output on and off to "off" (CF06: oFF).	p.36			
Even when the PMX-A series is configured so that output is turned on at power-on, the output is turned off immediately after the power is turned on.	Has the overvoltage protection (OVP) function been activated?	Set the OVP value higher than the voltage setting.	p.28		
	Has the overheat protection (OHP) function been activated?	The internal temperature is abnormally high. Check the operating conditions. After you have removed the cause of the abnormal temperature, turn the power switch on.	p.30		
		The air inlet (louver) may be clogged, or the fan may be broken. Check these items.	—		



## The output is unstable

Symptom	Items to check	Remedy	See
When the output is on, turning the VOLTAGE knob or CURRENT knob results in unstable output.	Is the operation mode switching from CV to CC or CC to CV?	Change the setting (output voltage or output current) that is limiting the output to a value greater than the present setting. If the setting is at maximum, you must use a power supply that has a larger output voltage or current.	p.26
The output voltage or output current fluctuates.	Is the remote sensing feature turned on?	When you are not using remote sensing, turn off the sensing switch.	p.18
	Are both the CV and CC LEDs turned on?	If the output is oscillating when you are using remote sensing, insert a capacitor across the load. The circuit may be malfunctioning. Immediately stop using the PMX-A series, and have it repaired.	p.18
	Do the sensing cables or load cables have poor contact, or are the cables broken?	Turn the POWER switch off, and check the wiring.	p.16 p.18
	Does the load current have peaks, or is it pulse shaped?	The peak values may be exceeding the set constant current. Increase the set constant current or increase the current capacity.	p.13 p.26
The output voltage is offset from the voltage that the PMX-A series was generating when it was turned on.	Has 30 minutes passed since the power was turned on?	Warm up the PMX-A series for at least 30 minutes.	—



## The output ripple is large

Symptom	Items to check	Remedy	See
The ripple sometimes becomes large.	Is the input voltage outside the range?	Apply a voltage that is within the input voltage range.	MANUAL SPEC
The ripple increased when the PMX-A series was installed in a different location.	Is something nearby generating a strong magnetic or electrical field?	Take measures such as moving the PMX-A series away from the field sources or twisting the cables connected to the PMX-A series.	—
The output ripple is large during external control.	Is there a large amount of external voltage noise?	Take measures against noise.	—
The ripple increased when the load cable was changed.	Are the remote sensing cables connected?	When you are not using remote sensing, disconnect the remote sensing cables.	p.18

## Unable to perform panel operations

Symptom	Items to check	Remedy	See
Unable to perform panel operations.	Is the LOCK LED lit?	Release the panel operation lock.	p.41
	Is the REMOTE LED lit?	To control the PMX-A series from the panel, press the LOCAL switch to switch to local mode.	p.41
	Is the PMX-A series being controlled via the RS232C, USB, or LAN interface?		
The PMX-A series does not switch to local mode even when the LOCAL switch is pressed.	Was a local lockout (llo) command sent through the communication interface?	Send the "SYST:LOC" communication command to clear the local lockout (llo) status.	—

## The ALARM LED lights when the OUTPUT switch is turned on

Symptom	Items to check	Remedy	See 
The ALARM LED lights when the OUTPUT switch is turned on.	Is the OVP activation point set to a value less than the output voltage?	Set the OVP activation point to a value higher than the output voltage.	p.28
	Is the OCP activation point set to a value less than the output current?	Set the OCP activation point to a value higher than the output current.	
	Is the remote sensing feature turned on?	When you are not using remote sensing, turn off the sensing switch.	p.18
		Set up the environment so that the voltage drop in each load cable is within the compensation voltage range (0.6 V for a single line).	p.18
	Are the polarities of the remote sensing cables connected in reverse?	The polarities of the remote sensing cables may be connected in reverse, or the ends of the cables may be shorted. Check the load cables.	p.18
	Are you using external control with a loose control cable?	Connect the cable correctly.	p.44
	Is the external voltage excessive during external control?	Apply the correct voltage.	p.49 p.51
	Is the internal temperature too high?	The overheat protection function (OHP) has been activated. Check the operating environment.	p.30 
The ALARM LED lights when the load is changed.	Is a large external voltage, such as that of a battery load, being applied?	The overvoltage protection function (OVP) or the overcurrent protection function (OCP) may have been activated. Check these items.	p.27
	Is the actual output voltage higher than the set voltage that is displayed on the panel?	The PMX-A series may be overloaded. Check the load.	
	Is a special load connected?	The PMX-A series may be overloaded. Check the load.	—

## Unable to perform remote control

Symptom	Items to check	Remedy	See 
Remote control through the communication interface cannot be performed.	Have you selected the communication interface that you want to use in the CONFIG settings?	Select the remote control communication interface (CF20).	p.37
When the LAN interface is in use, the DHCP server's automatic IP address assignment cannot be finalized.	When the POWER switch is turned on, does the LAN interface display persist for more than 30 seconds?	A timeout may have occurred while the PMX-A series was waiting for a response from the DHCP server or because no response was received. Consult your network administrator.	p.11
When the LAN interface is in use, the IP address cannot be obtained from the DHCP server.	Is the LAN LED lit in orange or red?	If it is lit in orange, the PMX-A series is waiting for a response from the DHCP server. If it turns red afterward, the PMX-A series may have timed out. Consult your network administrator.	p.37

# Index

<b>A</b>	
alarm	
clearing .....	27
display .....	28
occurrence .....	27
alarm signal .....	27
<b>C</b>	
CC control setting .....	36
CC mode .....	24
constant-current mode .....	24
constant-voltage mode .....	24
CV control setting .....	36
CV mode .....	24
<b>D</b>	
DHCP .....	37
Dimensions .....	84
<b>E</b>	
external monitoring .....	55
<b>F</b>	
factory default settings .....	42
firmware version .....	2
front panel .....	6
<b>I</b>	
initialization .....	42
IP address display .....	38
IP address, auto .....	37
IP address, manual .....	37
<b>J</b>	
J1 connector pin arrangement .....	45
<b>K</b>	
key lock function .....	41
<b>L</b>	
LAN interface	
resetting .....	38
restart .....	38
<b>M</b>	
MAC address display .....	38
memory contents, display .....	35
<b>O</b>	
OCP .....	28
OHP .....	30
output on and off	
external control .....	36
external control logic .....	36
output-on startup state .....	36
OVP .....	28
<b>P</b>	
power-on status .....	35
product ID display .....	39
protection function	
overcurrent protection .....	28
overheat protection .....	30
overvoltage protection .....	28
<b>R</b>	
rear panel .....	8
remote interface .....	37
remote sensing .....	18
<b>S</b>	
SCPI communication error display .....	37
settings, reset .....	35
SHIFT .....	3
<b>T</b>	
troubleshooting .....	88
<b>V</b>	
vendor ID display .....	38
version .....	2

This page has been intentionally left blank.





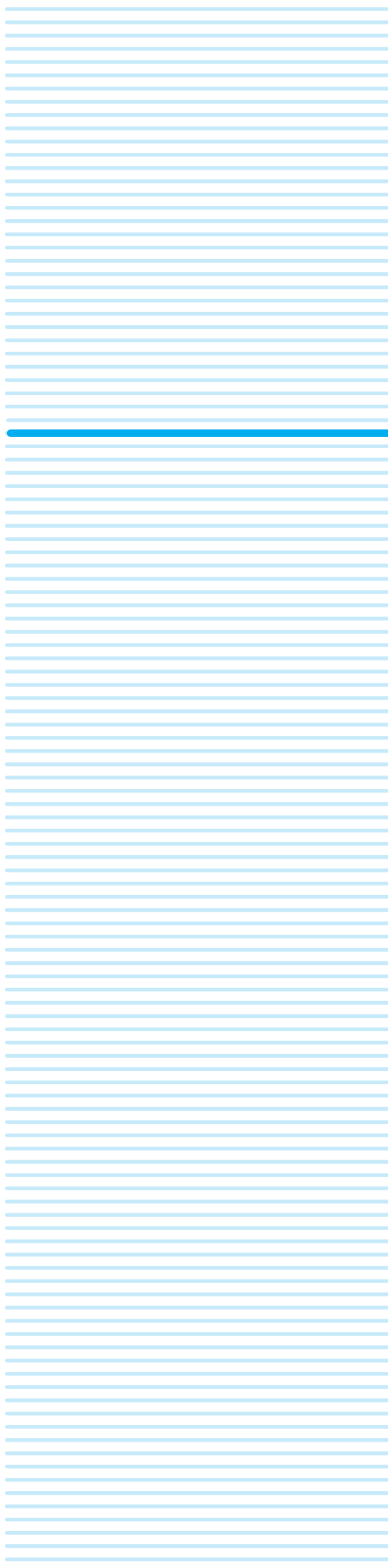

## **KIKUSUI ELECTRONICS CORP.**

---

1-1-3 Higashiyamata, Tsuzuki-ku, Yokohama,  
224-0023, Japan

Tel: +81-45-482-6353

Fax: +81-45-482-6261

**[www.kikusui.co.jp/en](http://www.kikusui.co.jp/en)**

