

User's Manual

PLZ-5WZ Impedance Measurement System
(SPEC21192)

Application Software

Imp. Meas. for PLZ-5WZ

Electronic load for impedance measurement

PLZ205WZ

PLZ405WZ

PLZ1205WZ

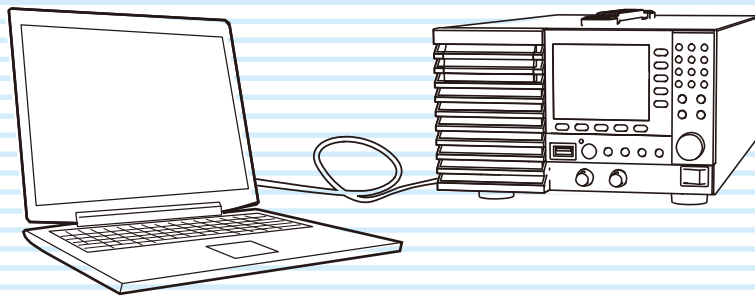

Contents 5

Installing the Software 6

Connecting and Configuring
the System 11

Starting the System 31

Measurement 36

Specifications 43

Appendix 45

About Manuals

These manuals provide an overview of the product and notes on usage. They also explain how to configure it, operate it, perform maintenance on it, and so on. Read these manuals thoroughly before use, and use the product properly.

Intended readers

These manuals are intended for users of the impedance measurement system and their instructors. The manuals assume that the reader has knowledge about power supplies.

Manual construction

PLZ-5WZ Impedance Measurement System

- User's Manual (this manual)
This document is intended for first-time users of the impedance measurement system. It provides an overview of the product, notes on usage, and specifications. It also explains how to connect the product, configure the product, operate the product, and so on.
- Safety information
This document contains general safety precautions. Keep them in mind and make sure to observe them.

To use the PLZ-5WZ electronic load for impedance measurement as a general-purpose PLZ-5W electronic load, use the following manuals.

- PLZ-5W Series Electronic Load CD-ROM
User's Manual
Communication Interface Manual
- Quick Reference
- Setup Guide
- Safety information

Product versions that this manual covers

- Imp. Meas. for PLZ-5WZ
This manual applies to versions 1.0.x of this product.
For information on how to check the version, see "Starting ImpMeas (p. 10)".
- PLZ-5WZ electronic load for impedance measurement
This manual applies to products with firmware versions 10.0X.
For information on how to check the firmware version, see "Displaying the Device Information".
When contacting us about the product, please provide us with:
 - The model (marked in the top section of the front panel)
 - The firmware version
 - The serial number (marked on the rear panel)

Trademarks

Microsoft, Windows, and Excel are registered trademarks or trademarks of Microsoft Corporation in the United States and/or other countries.

Other company names and product names used in this manual are generally trademarks or registered trademarks of the respective companies.

Copyright

Reproduction and reprinting of this operation manual, whole or partially, without our permission is prohibited.

Both unit specifications and manual contents are subject to change without notice.

© Copyright 2018 Kikusui Electronics Corporation



环境保护使用期限 Environment-friendly Use Period

该标记为适用于在中华人民共和国销售的电子信息产品的环境保护使用期限。只要遵守有关该产品的安全及使用注意事项，从制造年月起计算，在该年度内，就不会对环境污染、人身、财产产生重大的影响。

产品的废弃请遵守有关规定。

产品的制造年月可以在以下网址中确认。

<http://www.kikusui.co.jp/pi/>

有毒有害物质或元素名称及含有标示 Name of hazardous materials and symbol of element in the equipment and quantity

部件名称	有毒有害物质或元素 Hazardous material and symbol of element					
	铅 Pb	汞 Hg	镉 Cd	六价铬 Cr(VI)	多溴联苯 PBB	多溴二苯醚 PBDE
印刷电路板组装机	×	○	○	○	○	○
显示器	×	○	○	○	○	○
内部接线	○	○	○	○	○	○
外壳	×	○	○	○	○	○
底盘组装机 (含变压器)	×	○	○	○	○	○
辅助设备	○	○	○	○	○	○

本表格依据 SJ/T 11364 的规定编制。

○：该部件所有均质材料的有毒有害物质的含量不超过GB/T 26572标准所规定的极限值要求。

×：该部件至少有一种均质材料的有毒有害物质的含量超过GB/T 26572标准所规定的极限值要求。

System Configuration and Accessories

System Configuration

The impedance measurement system consists of the following products.

- Application software Imp. Meas. for PLZ-5WZ
- PLZ-5WZ electronic load for impedance measurement

Accessories

PLZ-5WZ electronic load for impedance measurement

The attached power cord varies depending on the shipment destination.

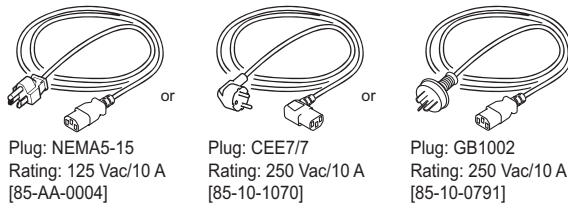

- Power cord (1 pc., length: 2.5 m)

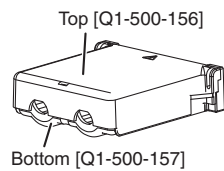

- Rear-panel load input terminal cover (1 pc.)

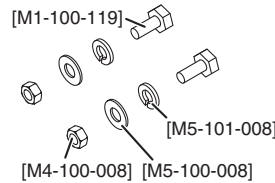

- Load input terminal screw set (2 sets)

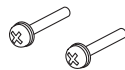

- Screws for the rear-panel load input terminal cover (2 pcs.) [M3-112-018]

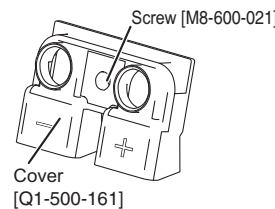

- Front-panel load input terminal cover (1 pc.)

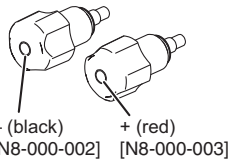

- Front-panel load input knob set (1 set)



- External control connector kit (1 set) [83-20-0190]

- Imp. Meas. for PLZ-5WZ CD-ROM (1 disc)
- PLZ-5WZ User's Manual (English/Japanese, 1 copy each)
- PLZ-5W Setup Guide (1 copy)
- PLZ-5W Quick Reference (English/Japanese, 1 sheet each)
- PLZ-5W CD-ROM (1 disc)
- Safety Information (1 copy)

Product Overview

This product adds an impedance measurement function based on an AC system to the general-purpose PLZ-5W electronic load. It is an impedance measurement system controlled through application software.

The system can be connected directly to a PC through USB or LAN.

This measurement system assumes that the device under test (DUT) is a battery or fuel cell (FC). With other DUTs, normal measurement may not be possible, or the measurement accuracy may not be satisfied.

The PLZ-5WZ electronic load for impedance measurement can be used as a general-purpose PLZ-5W electronic load.

Model	Max. operating current	Operating voltage	Power
PLZ205WZ	40 A	1 V to 150 V	200 W
PLZ405WZ	80 A	1 V to 150 V	400 W
PLZ1205WZ	240 A	1 V to 150 V	1200 W

Features

- An impedance measurement system can be configured easily with only an PLZ-5WZ electronic load and a dedicated software application.
- Impedance can be measured while running load current.
- Measurement of R, jX, and θ is possible in addition to impedance Z.
- The measurement frequency range is 100 Hz to 10 kHz (seven fixed settings). The signal level can also be adjusted as you like.
- Equipped with a voltage slope correction function that minimizes the effect of voltage slope due to battery discharge.
- Ensures accuracy during minute impedance measurement with the zero adjustment function.
- The measurement results and graphs of the application software can be copied directly to Microsoft Excel and the like.

Notations Used in This Manual

- In this manual, PLZ205WZ, PLZ405WZ, and PLZ1205WZ electronic loads for impedance measurement are also referred to as PLZ-5WZ.
- In this manual, application software Imp. Meas. for PLZ-5WZ is also referred to as ImpMeas.
- The term “PC” is used to refer generally to both personal computers and workstations.
- The term “DUT” is used to refer generally to a device under test.
- The screen captures and illustrations used in this text may differ from the actual items.
- The following markings are used in this manual.

WARNING

Indicates a potentially hazardous situation which, if ignored, could result in death or serious injury.

CAUTION

Indicates a potentially hazardous situation which, if ignored, may result in damage to the product or other property.

NOTE

Indicates information that you should know.

>

Indicates the hierarchy of items you need to select. The item to the left of this symbol indicates a higher level item.

Safety Precautions

When installing this product, be sure to observe the precautions provided in the Safety information manual.

Precautions When Choosing the Installation Location

When installing this product, be sure to observe the “Precautions When Choosing the Installation Location” in the Safety information manual. Items specific to this product are given below.

- When installing this product, be sure to observe the temperature and humidity ranges indicated below.
Operating temperature range: 0 °C to 40 °C
Operating humidity range: 20 %rh to 85 %rh (no condensation)
- When storing this product, be sure to observe the temperature and humidity ranges indicated below.
Storage temperature range: -20 °C to 70 °C
Storage humidity range: 90 %rh or less (no condensation)
- Do not install the product vertically.
It may cause injury to the operator or damage to the product when it falls down.

Contents

About Manuals	2
System Configuration and Accessories.....	3
Product Overview	3
Notations Used in This Manual.....	4
Safety Precautions	4
Precautions When Choosing the Installation Location.....	4

Installing the Software

System Requirements	6
Installing KI-VISA	7
Installing ImpMeas	8
Starting ImpMeas	10

Connecting and Configuring the System

Overview of Connection	11
Connecting the PLZ-5WZ to an AC Power Line.....	12
Turning the power on and off.....	13
Connecting the DUT to the PLZ-5WZ.....	14
Selecting the Load Cables.....	15
Connecting to the Load Input Terminals.....	17
Remote Sensing.....	19
Remote sensing configuration	19
Remote sensing connection	19
Basic PLZ-5WZ Configuration.....	21
CC mode setting.....	21
Current range and voltage range settings	21
Overpower protection (OPP) setting.....	22
Undervoltage protection (UVP) setting	23
Connecting the PLZ-5WZ to a PC through USB.....	24
USB communication settings on ImpMeas.....	24
Connecting the PLZ-5WZ to a PC through LAN.....	26
Checking and setting the PLZ-5WZ IP address ..	26
Setting the PC IP address	27
Registering the IP address	29
LAN communication settings on ImpMeas	30

Starting the System

Measurement Flowchart.....	31
Setting Measuring Conditions	32
0 ADJ (Zero Adjustment).....	34

Measurement

Executing a Measurement	36
Starting a measurement.....	36
When an alarm occurs in the PLZ-5WZ	37
Measurement Results	38
Displaying measurement results	38
Copying measurement results.....	38
Displaying the graph.....	39
Copying a graph	41
Always on Top function	41
Closing ImpMeas	42

Specifications

Measurement function.....	43
Functions of Imp. Meas. for PLZ-5WZ	43
Measurement accuracy	44

Appendix

How Impedance Measurement Works	45
Impedance Measurement for Each Single Cell	46
Effects of Input Impedance	47
Error Messages.....	49
Troubleshooting	51
Index	52

Installing the Software

System Requirements

- PC with Core2 CPU or later
- Windows 7 (32 bit, 64bit) or Windows 10 (32 bit, 64 bit)
- Minimum 2 GB or RAM
- 100 MB or more of free hard-disk space
- A display that supports a resolution of 1280 × 1024 or higher
- CD-ROM drive
- Mouse
- USB 2.0 or later or wired LAN (100Base-TX/10Base-T) interface
- USB or LAN cable (straight, crossover)

Installing KI-VISA



A VISA library must be installed in your PC to use Imp. Meas. for PLZ-5WZ. VISA (Virtual Instrument Software Architecture) was developed by the VXIplug&play Systems Alliance. It is the standard specification for measurement instrument connection software. You need one of the following VISA libraries.

- NI-VISA by National Instruments Corporation
- KI-VISA

KI-VISA is an original VISA library developed by Kikusui Electronics Corporation that supports the IVI VISA 5.0 specifications. You can download the most recent version of this library from the Kikusui Electronics Corporation website (<http://www.kikusui.co.jp/en/download/>). If NI-VISA is already installed on your PC, you do not need to install KI-VISA.

1 Load the Imp. Meas. for PLZ-5WZ setup CD-ROM into your PC.

The following two setup files are in the KI-VISA folder of the setup CD-ROM. Select the appropriate file according to your PC environment.

-  **kivisa_5_5_0_275(x64).exe** Setup file for 64 bit OS
-  **kivisa_5_5_0_275(x86).exe** Setup file for 32 bit OS

“.exe” may not be displayed depending on the PC environment.

2 Double-click the setup file.



The installer will set up several programs one at a time. Follow the setup wizard. When all programs have been set up, a setup complete window appears.

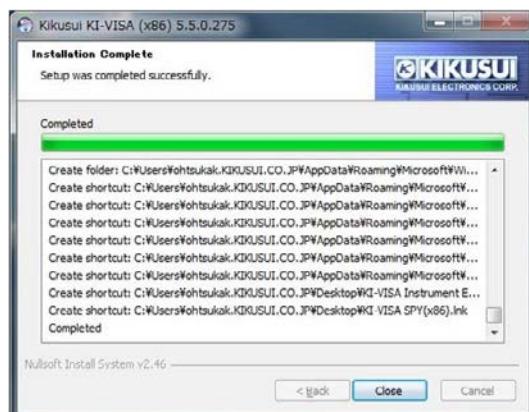

3 Click Close.

The installation is complete.

Installing ImpMeas

Install the application software Imp. Meas. for PLZ-5WZ.

1 Load the Imp. Meas. for PLZ-5WZ setup CD-ROM into your PC.

The following file is in the SETUP folder of the setup CD-ROM.

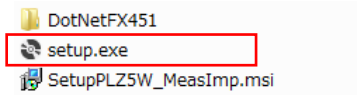

“.exe” may not be displayed depending on the PC environment.

2 Double-click setup.exe.

A .NET Framework installation dialog box appears. The installation of .NET Framework may be skipped if the appropriate .NET Framework is already installed.

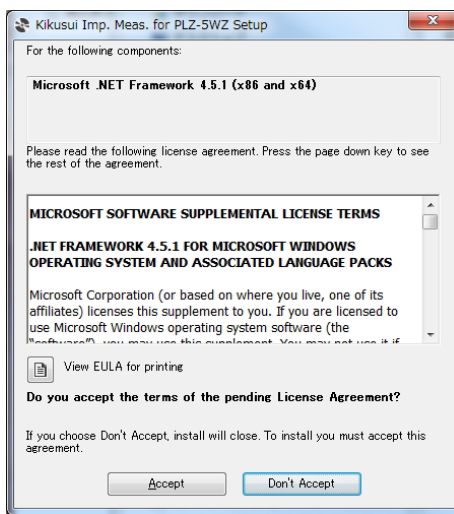

3 Click Accept.

The installation of .NET Framework begins. When the installation of .NET Framework is complete, An Imp. Meas. for PLZ-5WZ installation dialog box appears.

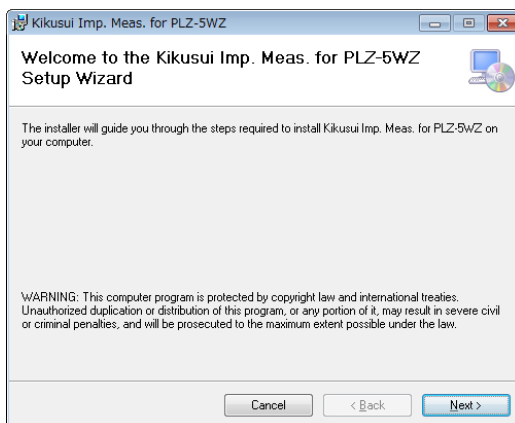

4 Click Next.

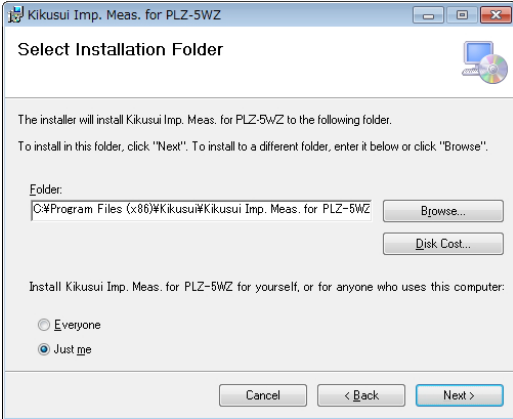

5 Select the installation location, and click Next.

If the installation is for all users, select Everyone; otherwise, select Just me.

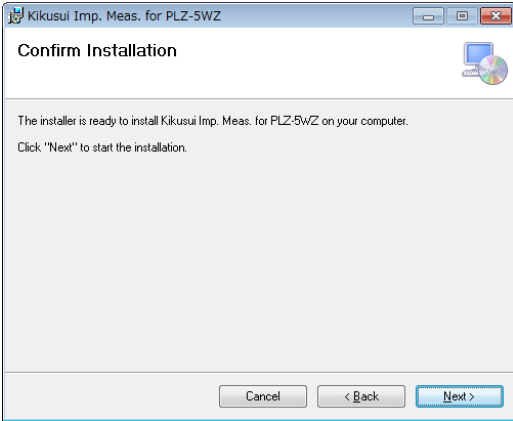

6 Click Next.

The installation begins.

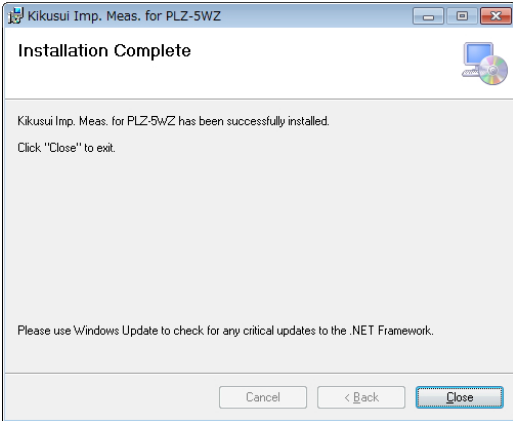

The installation is successful.

7 Click Close.

The installation is complete.

Starting ImpMeas

1 Double-click the Imp. Meas. for PLZ-5WZ icon on the desktop.

If the icon is not available on the desktop, select Programs > kikusui Imp.Meas.for PLZ-5WZ > Imp.Meas.for PLZ-5WZ.



The Imp. Meas. for PLZ-5WZ main window appears.

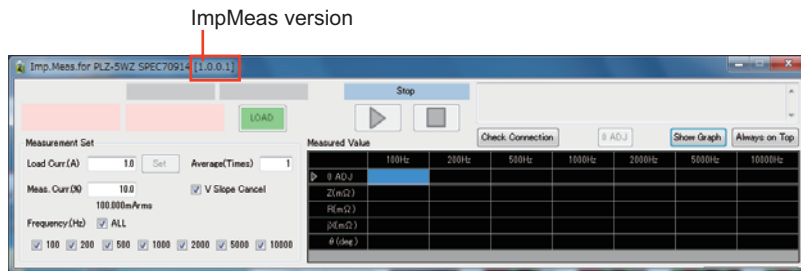

NOTE

- Use the software with Windows power-saving mode and screen saver disabled.
- Avoid running other software applications at the same time.
- If you are using a PC that has advanced power management (APM) or sleep mode, disable these functions.

Connecting and Configuring the System

Overview of Connection

The following figure shows the system connections. Use load cables with a core diameter that is appropriate for the DUT current. Load cables, remote sensing cables, USB or LAN cables are not included. You need to provide these yourself.

For details on the names of PLZ-5WZ components, see the PLZ-5W user's manual.

PLZ205WZ connection example

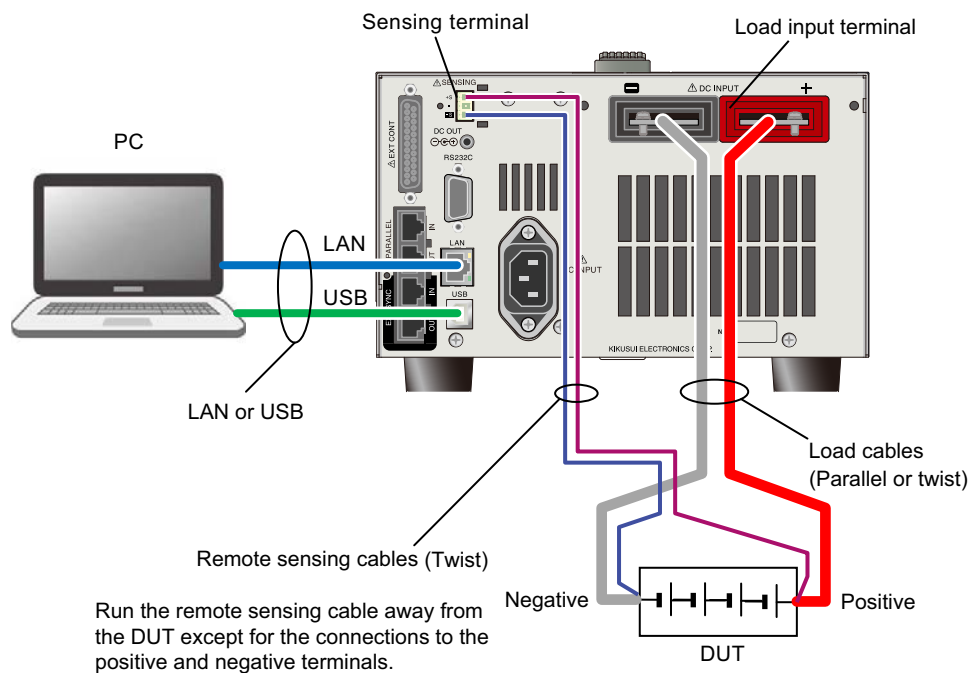

Connecting the PLZ-5WZ to an AC Power Line

WARNING

Risk of electric shock.

- The PLZ-5WZ is IEC Safety Class I equipment (equipment with a protective conductor terminal). To prevent electric shock, be sure to connect the protective conductor terminal of the product to electrical ground (safety ground).
- The PLZ-5WZ is grounded through the power cord ground wire. Connect the protective conductor terminal to earth ground.

NOTE

- Use the supplied power cord to connect to the AC line. If the supplied power cord cannot be used because the rated voltage or the plug shape is incompatible, have a qualified engineer replace it with an appropriate power cord that is 3 m or less in length. If obtaining a power cord is difficult, contact your Kikusui agent or distributor.
- The power cord with a plug can be used to disconnect the PLZ-5WZ from the AC power line in an emergency.
- Secure adequate space around the power plug. Do not insert the power plug to an outlet where accessibility to the plug is poor. And, do not place objects near the outlet that would result in poor accessibility to the plug.
- Do not use the supplied power cord with other instruments.

The PLZ-5WZ conforms to IEC Overvoltage Category II (energy-consuming equipment that is supplied from a fixed installation).

- 1 Turn the POWER switch off (O).**
- 2 Check that the AC power line meets the nominal input rating of the PLZ-5WZ.**
The product can receive a nominal line voltage in the range of 100 Vac to 240 Vac at 50 Hz or 60 Hz. (Frequency range: 47 Hz to 63 Hz)
- 3 Connect the power cord to the AC INPUT inlet on the rear panel.**
- 4 Connect the power cord plug to an outlet with a ground terminal.**

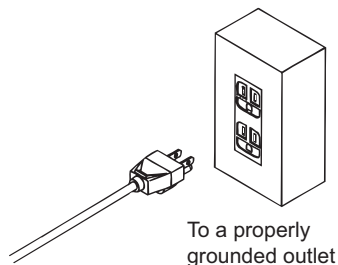

This completes the connections.

Turning the power on and off

Turning the power on

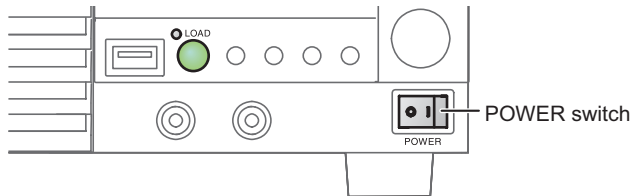

- 1** Check that the power cord is connected correctly.
- 2** Check that nothing is connected to the DC INPUT (load input) terminals on the front and rear panels.
- 3** Turn the POWER switch on (I).
The PLZ-5WZ turns on, and the display lights.

If you notice strange sounds, unusual odors, fire, or smoke around or from inside the PLZ-5WZ, flip the POWER switch off, or remove the power cord plug from the outlet.

Turning the power off

Press the (O) side of the POWER switch to turn the power off.

-
- ⚠ CAUTION**
- If you want to turn the POWER switch back on, wait at least 5 seconds after the fan stops. Repeatedly turning the POWER switch on and off at short intervals will shorten the service life of the POWER switch and the internal input fuse.
-

Connecting the DUT to the PLZ-5WZ

The PLZ-5WZ has load input terminals on both its front and rear panels, but use the input terminals on the rear panel for impedance measurements. See “Selecting the Load Cables” (p. 15), and select the appropriate cables.

Large current load cables are available as options. For details, see the Large Current Load Cable Manual in the CD-ROM of the general-purpose PLZ-5W electronic load.

 **WARNING**

Risk of electric shock.

- Do not touch load input terminals when the output is turned on.
- The load input terminals on the front panel are connected internally to the load input terminals on the rear panel. The voltage applied to the terminal on one side appears directly at the terminal on the other side.

 **CAUTION**

Risk of damage.

- Do not connect the DUT to the load input terminals while the PLZ-5WZ load is turned on.
- Do not invert the polarity when connecting. An overcurrent may flow when the load is turned on.

Risk of overheating.

- Use the supplied screws to connect the cables with crimping terminals.
-

Selecting the Load Cables



WARNING

- **Risk of fire.** Use load cables whose capacity is adequate for the PLZ-5WZ's rated output current.
- **Risk of electric shock.** Use load cables with a voltage rating that meets or exceeds the isolation voltage (± 500 V) of the PLZ-5WZ's load input terminals.



CAUTION

Use load cables with a core diameter that is appropriate for the amount of current being used and with sturdy, flame-resistant insulation.

Current capacity of load cables

If the resistance of the cables used as the load cables is large, a large voltage drop may occur when current flows through the cables. This may result in the load input terminal voltage being lower than the minimum operating voltage of the PLZ-5WZ. Using the following table as a reference, select wiring whose nominal cross-sectional area is as thick as possible.

A wire's temperature is determined by the resistive loss based on the current, the ambient temperature, and the wire's external thermal resistance. The following table shows the current capacity of heat-resistant vinyl wires that have a maximum allowable temperature of 60 °C when one of the wires is separated and stretched out horizontally in air in an ambient temperature of 30 °C. The current must be reduced under certain conditions, such as when vinyl cables that have a low heat resistance are used, when the ambient temperature is 30 °C or greater, or when cables are bundled together and little heat is radiated.

Nominal cross-sectional area (mm ²)	AWG	(reference cross-sectional area mm ²)	Allowable Current ¹ [A](Ta = 30 °C)	Kikusui Recommended Current [A]
14	6	(13.3)	88	50
22	4	(21.15)	115	80
30	2	(33.62)	139	-
38	1	(42.41)	162	100
50	1/0	(53.49)	190	-
60	2/0	(67.43)	217	-
80	3/0	(85.01)	257	200
100	4/0	(107.2)	298	-
125	-	-	344	-
150	-	-	395	300
200	-	-	469	-
250	-	-	556	-
325	-	-	650	-

1 Excerpt from Japanese laws related to electrical equipment.

■ Taking measures against noise

When connecting cables that have the same heat resistance, separating the cables as much as possible to increase heat radiation enables a greater amount of current to flow. However, wiring the positive (+) and negative (-) output wires of the load cable side by side or bundling them together is more effective against unwanted noise. The Kikusui-recommended currents shown in the above table are allowable currents that have been reduced in consideration of the potential bundling of load cables. Use these values as a guideline when connecting load cables.

Types of load cables

Ensure that the current capacity of the load cables is sufficient for the current to be drawn from the DUT. The current capacity is proportional to the conductor cross-sectional area of the cables. The conductor cross-sectional area is determined by the cross-sectional area of each wire and the number of wires as shown in the figure below. As such, the larger the current, the greater the number of wires required. Consequently, the cable becomes thick, and the weight per unit length becomes significant. Particularly for large current use, there are cables with braided conductors (often referred to as earth cables, flat braided copper cables, flat braided copper cables).

Normal cable

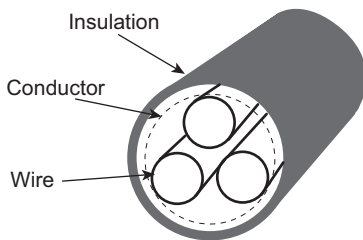

Cross-sectional area (nominal value)
= cross-sectional area of wire × the number of wires

Flat braided cable

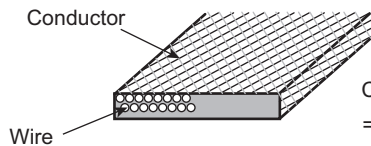

Cross-sectional area (nominal value)
= cross-sectional area of wire × the number of wires

Relationship between voltage drop in cables and impedance measurement

When the positive cable and negative cable are twisted well, the cable inductance is normally about 1 μH per meter of the cable. Let's assume that the electronic load and the DUT is connected using 1 m of cable (1 m positive cable and 1 m negative cable twisted together). In this case, the cable conductance is calculated by 1 $\mu\text{H}/\text{m} \times 1 \text{ m}$, which gives 1 μH .

The reactance is ωL (where ω is the angular frequency given by frequency $\times 2\pi$ and L is the inductance). Therefore, the reactance is 0.628 m Ω at 100 Hz, 6.28 m Ω at 1 kHz, and 62.8 m Ω at 10 kHz. If the measurement AC current is 10 Arms, a voltage drop of 1.25 Vrms (3.54 Vpp) will occur.

The cable also has DC resistance, so the voltage obtained by subtracting this voltage drop also from the DUT output voltage must be greater than the minimum input operating voltage of the electronic load.

The following items may be constrained depending on the cable conditions.

- Maximum measurement AC current
- Upper measurement frequency limit
- Minimum DUT voltage

Connecting to the Load Input Terminals

Connect the DUT to the load input terminals on the rear panel.



WARNING

Risk of electric shock.

- Be sure to attach the cover for the load input terminals on the rear panel.
- Be sure to attach the protection plate also to the load input terminal on the front panel. The voltage applied to the load input terminals on the rear panel appears at the load input terminals on the front panel.

1 Press LOAD.

The value switches between load on and load off each time you press the key. Here, turn the load off.

The load on LED turns off.

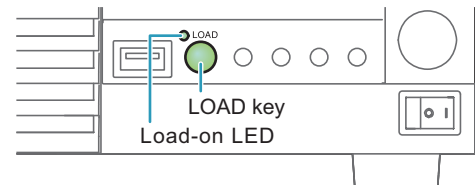

2 Attach crimping terminals to the load cables.

The load input terminals on the rear panel have bolt (M10) holes for connecting the load cables. Attach the appropriate crimping terminals to the cables.

3 Connect the load cables to the load input terminals on the rear panel using the included load input terminal screw set.

To prevent interference with the cover for the load input terminals on the rear panel, basically connect the crimping terminals in orientation (1) in the figure. If the crimping terminals are small and cannot be connected in orientation (1), connect them in orientation (2).

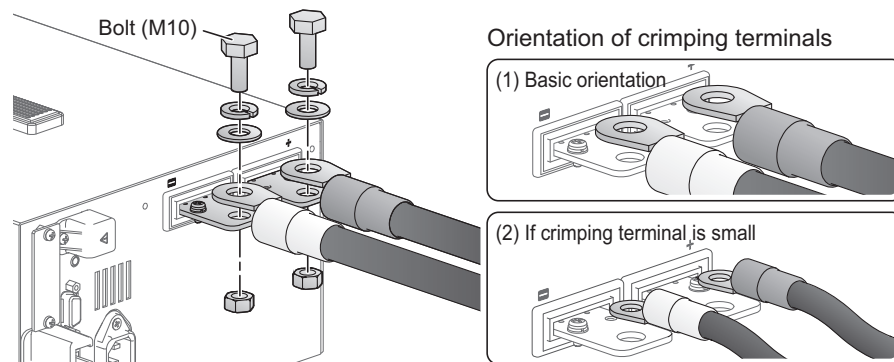

4 Place the bottom half of the cover for the load input terminals on the rear panel underneath the cables connected to the load input terminals.

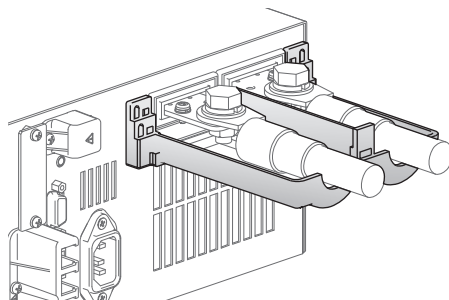

5 Align the tabs of the top cover for the load input terminals on the rear panel with those of the bottom cover.

Align the tabs of the load input terminal cover according to the load cable diameter.

You can adjust the diameter of the holes that the load cables pass through by changing the position that the top and bottom covers are put together. There are two available positions. Use the appropriate position for the load cables that you are using.

- For cables up to $\varnothing 10$ mm: Put the top and bottom load input terminal covers together so that the hole diameter is small.
- For cables that are between $\varnothing 10$ and 20 mm: Put the top and bottom load input terminal covers together so that the hole diameter is large.

For thin load cables (up to $\Phi 10$)

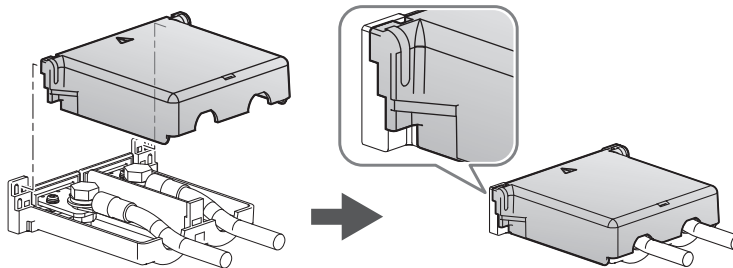

For thick load cables ($\Phi 10$ to $\Phi 20$)

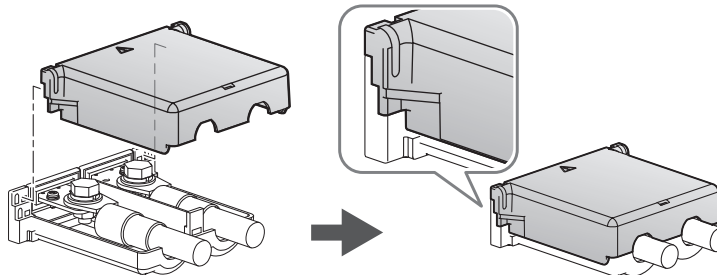

6 Push the cover for the load input terminals on the rear panel against the panel, and fasten it with the included screws.

Make sure that the screws are securely fastened.

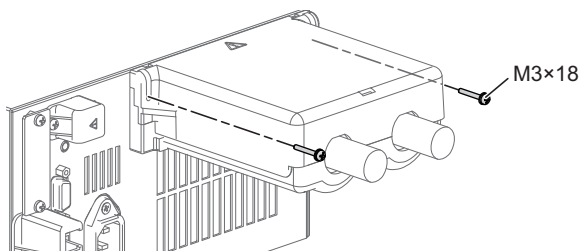

7 Connect the load cables to the terminals of the DUT.

Connect the positive (+) polarity of the load input terminal on the rear panel to the positive (+) polarity of the DUT, and the negative (-) polarity of the load input terminal on the rear panel to the negative (-) polarity of the DUT.

This completes the connections.

Remote Sensing

ImpMeas requires the PLZ-5WZ to be used with remote sensing. For this, you need to configure the PLZ-5WZ and make connections for remote sensing.

Remote sensing configuration

The PLZ-5WZ remote sensing can be configured from ImpMeas. After starting ImpMeas, configuring the interface communication settings automatically enables PLZ-5WZ remote sensing.

NOTE • The remote sensing setting does not change even when you close ImpMeas.

Remote sensing connection

- ⚠ CAUTION**
- Risk of damage to the internal circuitry. Never wire the sensing terminals while the POWER switch is turned on.
 - If the remote sensing cables come loose while remote sensing is in use, the PLZ-5WZ and DUT may be damaged. Be sure to connect the cables securely.

Unlike the load cables, there is no need to consider the current capacity for the sensing cables. However, for adequate mechanical strength, use wires whose nominal cross-sectional area is 0.5 mm² or greater.

- 1 Turn the POWER switch off.
- 2 Remove the sensing terminal cover on the rear panel.

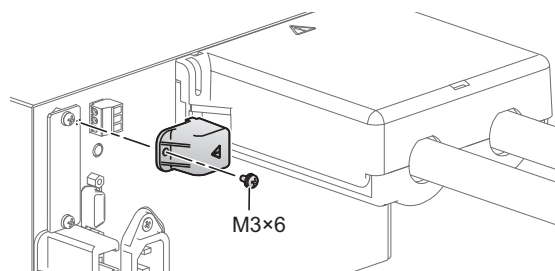

3 Connect the sensing cables to the PLZ-5WZ.

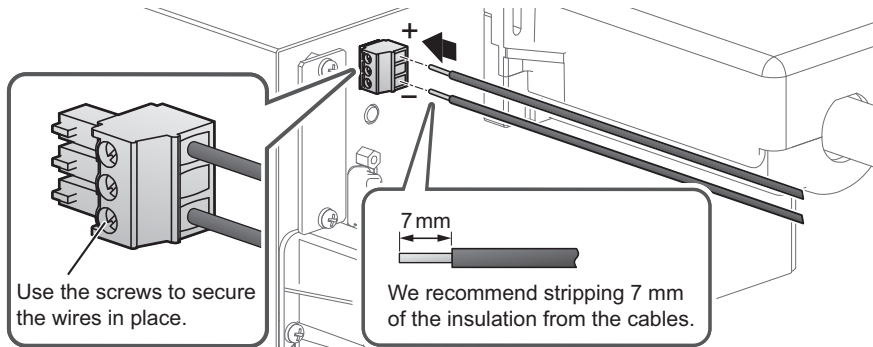

4 Attach the sensing terminal cover.

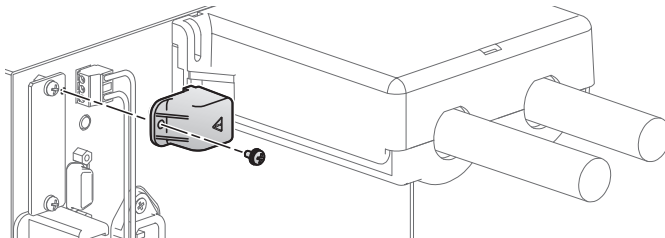

5 Connect the sensing cables to the DUT.

Connect the positive (+S) polarity of the SENSING connector to the positive (+) polarity of the DUT, and connect the negative (-S) polarity of the SENSING connector to the negative (-) polarity of the DUT.

Connect the cables as close to the DUT as possible.

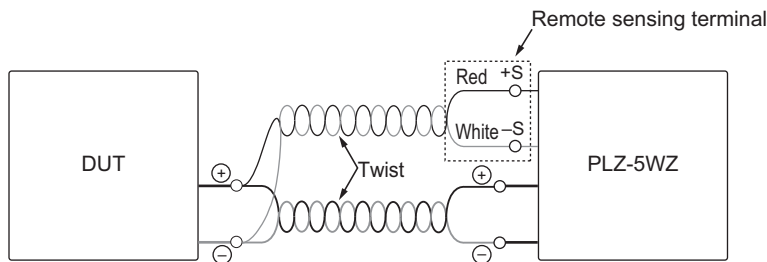

■ Limitations of the remote sensing

All wires have resistance. As the wire becomes longer or the current becomes larger, the voltage drop in the wire becomes greater. This results in a smaller voltage being applied at the load input terminal.

Basic PLZ-5WZ Configuration

CC mode setting

Always set the mode to CC. Impedance measurement is not possible in other modes.
The factory default setting is CC mode.

1 Press SOURCE > MODE > CC.



Current range and voltage range settings

The current range that can be specified varies depending on the PLZ-5WZ model. Select the appropriate range according to the voltage and load current of the DUT. Selecting an unnecessarily large range may degrade the accuracy of impedance measurements.

NOTE

- When ImpMeas starts, it acquires PLZ-5WZ's range information and uses it as parameters for measurement calculations. If you change the range, you need to restart ImpMeas (p.10).

1 Press SOURCE and then Range.

2 Use the sub-function keys to set the current range and the voltage range.

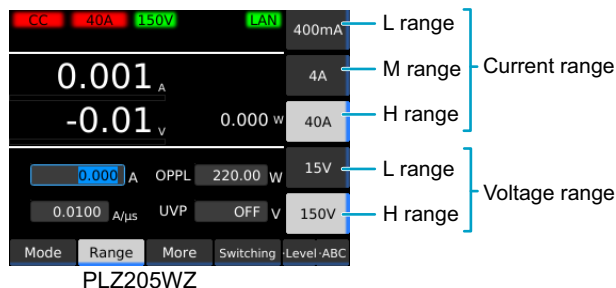

This completes the setting.

Overpower protection (OPP) setting

This function either puts a limit on the power (OPPL) or turns off the load of the PLZ-5WZ (OPPT) when a current that is equal to or exceeds the set value is applied to the PLZ-5WZ. You can set the overpower protection setting and the operation when an alarm occurs.

If the OPP value is set to 110 % of the L range rating or M range rating or higher, an alarm occurs when the power is at 110 % of each range's rating.

You can set this function when the load is off.

1 Press Source and then Level.

2 Press OPP to select OPP.

Each time you press the key, the selected item changes.



3 Use the numeric keypad or the rotary knob to enter the power value.

4 Press Action and select the operation when an alarm occurs.



Each time you press the key, the item changes.

Item	Description
Trip	Turns the load off.
Limit	Limits the power so as not to exceed the set value.

This completes the setting.

Undervoltage protection (UVP) setting

This function turns off the load of the PLZ-5WZ when the voltage applied to the PLZ-5WZ becomes equal to or less than the UVP setting. You can also turn UVP off.

You can set this function when the load is off.

1 Press Source and then Level.

2 Press UVP to select UVP.

Each time you press the key, the selected item changes.



3 Use the numeric keypad or the rotary knob to enter the voltage value.

To turn this off, turn the rotary knob counterclockwise to select OFF.

This completes the setting.

Connecting the PLZ-5WZ to a PC through USB

Connect the PLZ-5WZ to a PC using a USB cable that meets the following conditions (p. 11).

- Standard B type socket (PLZ-5WZ side)
- USB 2.0 compatible. Data rate: 480 Mbps (High Speed)

USB communication settings on ImpMeas

As long as the PLZ-5WZ is connected to the PC through USB, you do not need to change these settings in the future.

1 Start ImpMeas.

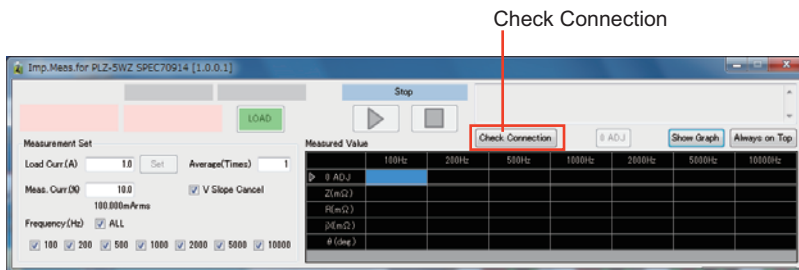

2 Click Check Connection.

A System setting dialog box appears.

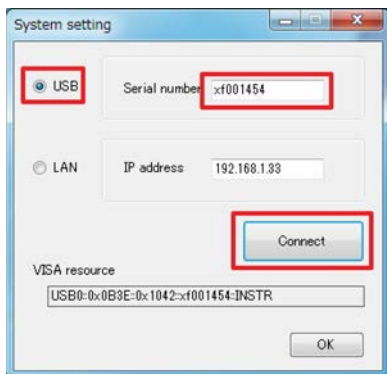

3 Select USB.

4 In the Serial number box, enter the PLZ-5WZ serial number.

To view the PLZ-5WZ serial number, on the PLZ-5WZ, press SYSTEM > Information.

5 Click Connect and then OK.

If the connection is successful, the "Connection succeed" message appears.

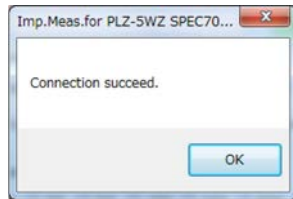

6 Click OK to close all dialog boxes.

This completes the setting.

■ **If connection fails**

If the following message appears, connection has failed.

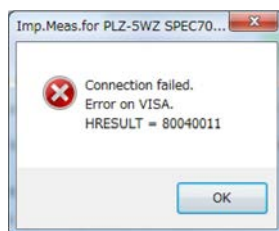

Click OK, and perform the following:

- Check the serial number.
To view the PLZ-5WZ serial number, on the PLZ-5WZ, press SYSTEM > Information.
If there was a mistake in the serial number, return to step 4.
- Remove the USB connector and reconnect it. Then return to step 5.

Connecting the PLZ-5WZ to a PC through LAN

Connect the PLZ-5WZ to a PC using a LAN cable that meets the following conditions (p. 11).

- IEEE 802.3 100Base-TX/10Base-T Ethernet
- Auto-MDIX compatible (straight or crossover)
- IPv4, RJ-45 connector

Checking and setting the PLZ-5WZ IP address

When connecting the PLZ-5WZ to a PC through LAN, assign fixed IP addresses to both. By factory default, the PLZ-5WZ IP address is set to 192.168.1.33. Normally, if you assign a different IP address to the PC, you can start using the system. If you need to change the PLZ-5WZ IP address, follow the procedure below.

1 Turn on the PLZ-5WZ's POWER switch (|).

2 Press SYSTEM > Interface.

The Interface screen appears.

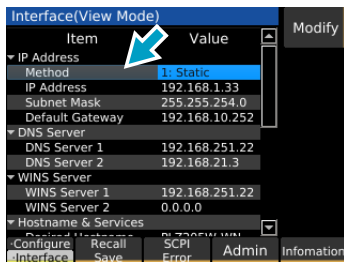

3 Press Modify, and use the rotary knob to select Method.

4 Press Edit, use the numeric keypad or the rotary knob to select 1: Static.

5 Press Edit.

Method is set to Static.

6 Turn the rotary knob to select IP Address.

7 To change it, press Edit, and then use the numeric keypad to enter the IP address you want.

8 Press Apply and then ENTER.

This completes the setting.

Setting the PC IP address

The procedure is explained using Windows 7 as an example.

1 Select Control Panel.

The Control Panel opens.

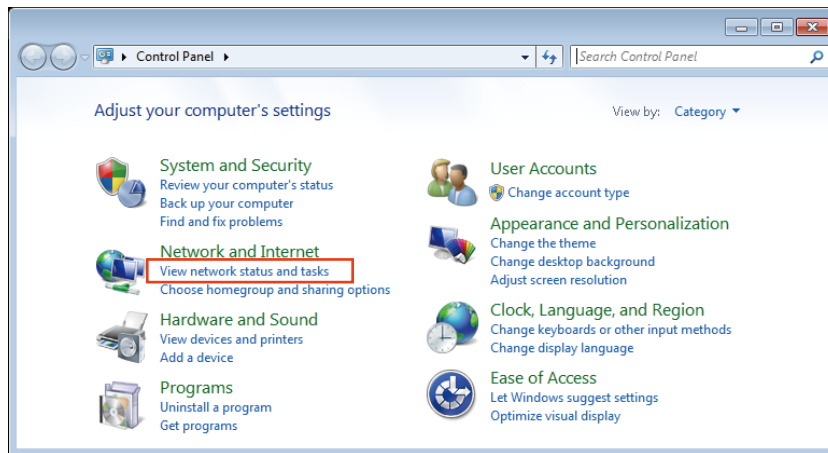

2 Select View network status and tasks.

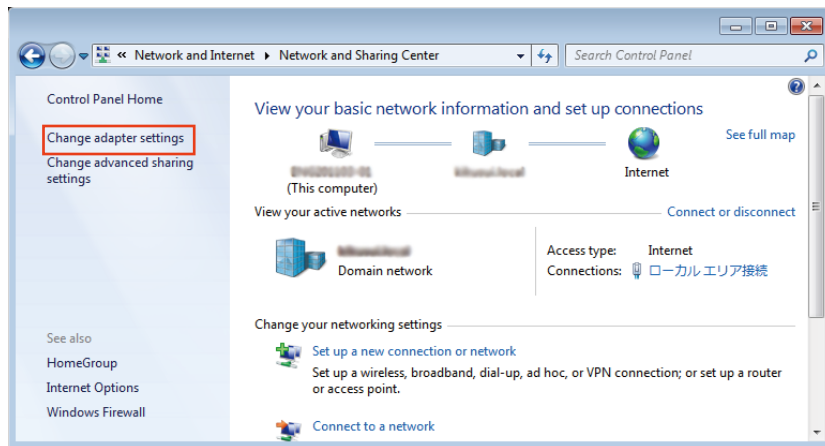

3 Select Change adapter settings.

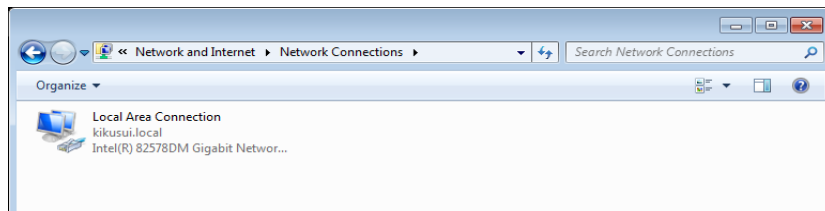

4 Right-click Local Area Connection, and select Properties from the shortcut menu.

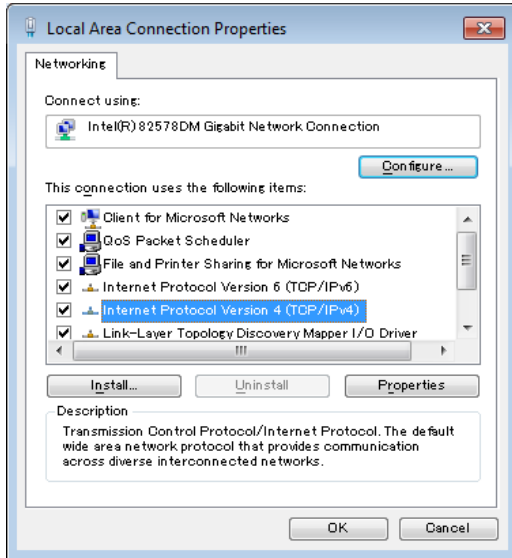

5 Select the Internet Protocol Version 4 (TCP/IPv4) check box, and then click Properties.

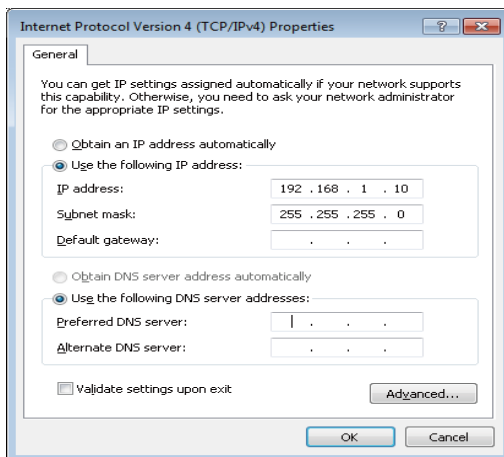

6 Enter the IP address.

Set the PC IP address to 192.168.1.10 or the like as shown in the figure above.

The factory default PLZ-5WZ IP address is 192.168.1.33, and the IP address assignment method is Static. (p.26)

If you execute factory default initialization or reset the PLZ-5WZ, the IP address assignment method is set to Automatic, and the IP address is not set to 192.168.1.33.

7 Click OK to close all dialog boxes.

This completes the setting.

Registering the IP address

When connecting to LAN, the IP address that will be used must be registered in the VISA library. This setting is necessary when connecting to the PLZ-5WZ through LAN for the first time.

The procedure to configure KI-VISA is explained below. If NI-VISA is installed, refer to the NI-VISA manual. This registration is not necessary the next time.

1 Double-click the KI-VISA Instrument Explorer icon on the desktop.

If the icon is not on the desktop, on the task bar, click Start > All Programs, Kikusui IO Software>KI-VISA>Instrument Explorer.



2 Click KI-VISA IO Config, and select the LAN tab.

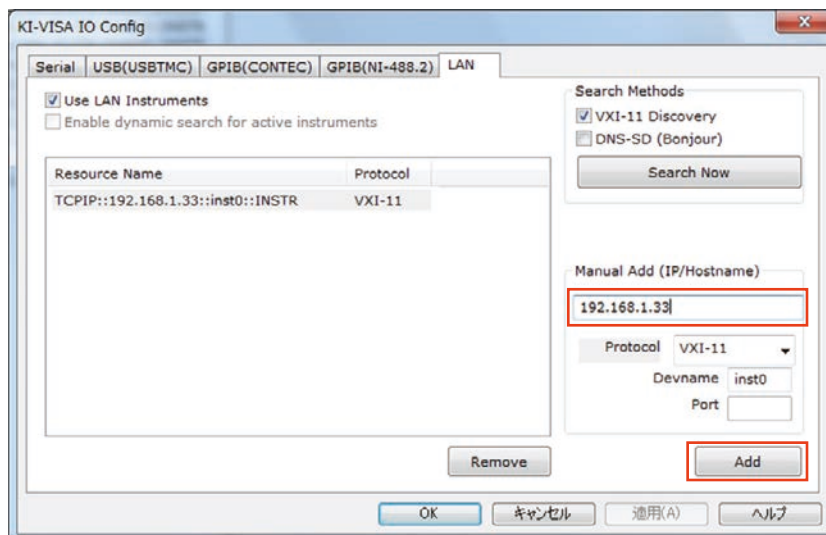

3 In the Manual Add (IP/Hostname), enter the PLZ-5WZ IP address (p.26), and click Add.

The IP address is displayed under Resource Name.

4 Click OK to close all dialog boxes.

This completes the setting.

LAN communication settings on ImpMeas

As long as the PLZ-5WZ is connected to the PC through LAN, you do not need to change these settings in the future.

1 Start ImpMeas.

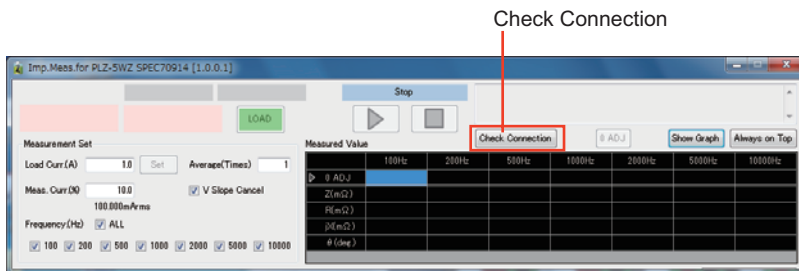

2 Click Check Connection.

A System setting dialog box appears.

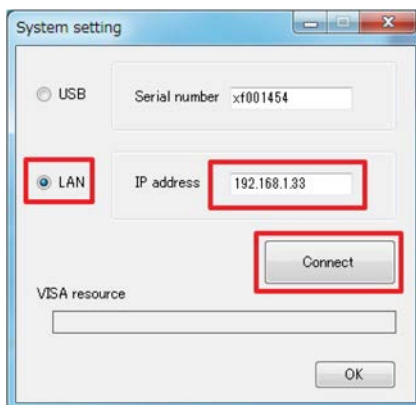

3 Click LAN.

4 In the IP address box, enter the PLZ-5WZ IP address (p.26).

5 Click Connect and then OK.

If the connection is successful, the "Connection succeed" message appears.



6 Click OK to close all dialog boxes.

This completes the setting.

■ If connection fails

If the following message appears, connection has failed.

Click OK, and check the items below. Then, return to step 2.

- "Setting the PC IP address" (p.27)
- "Registering the IP address" (p.29)

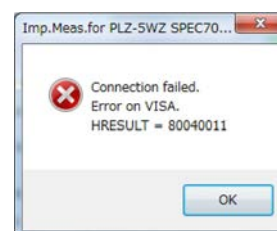

Starting the System

Measurement Flowchart

The following flowchart shows the measurement steps: setting measurement conditions, executing measurements, changing the conditions, and ending measurements.

When ImpMeas starts, it acquires PLZ-5WZ's range information and uses it as parameters for measurement calculations. If you change the range, you need to restart ImpMeas.

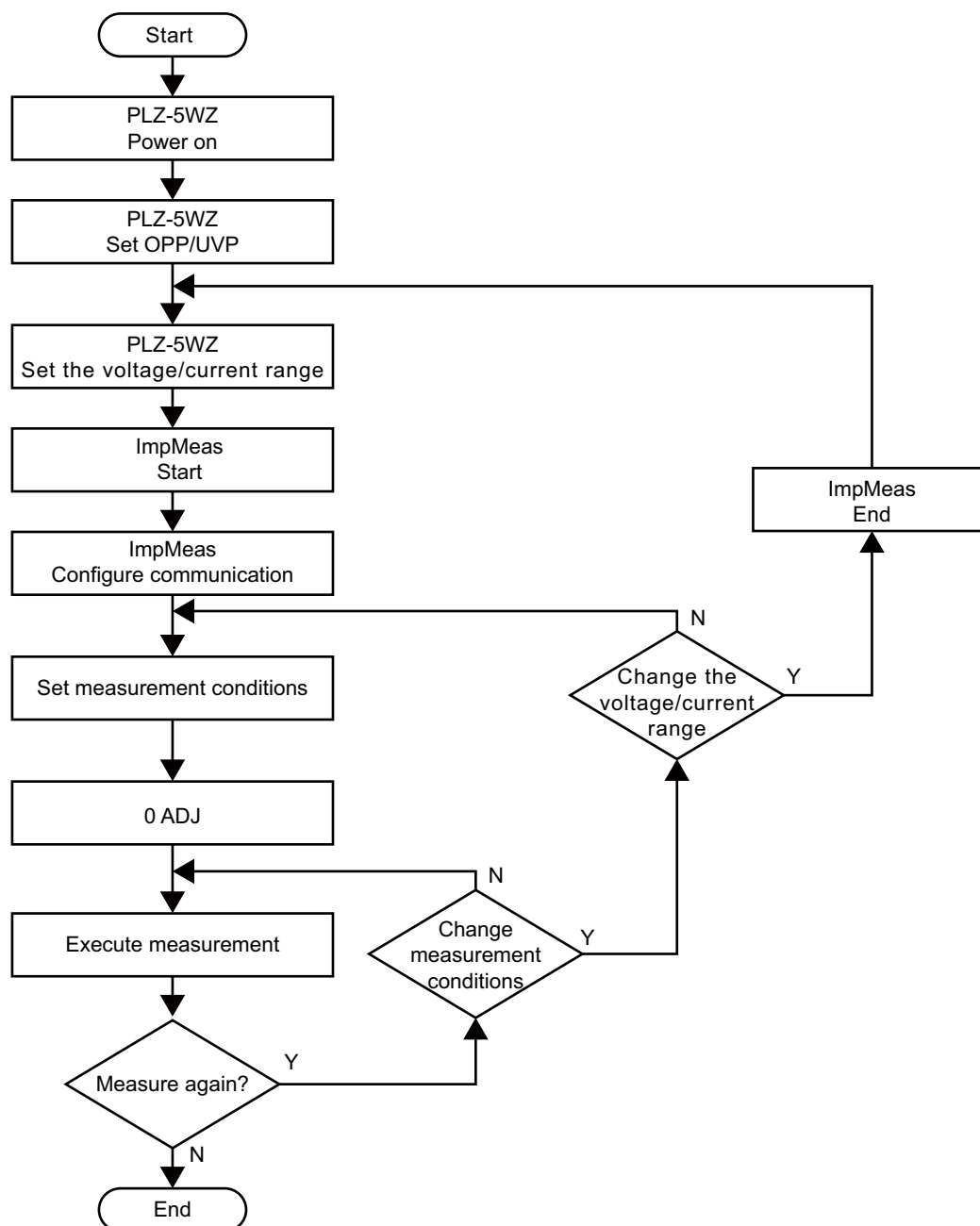

Setting Measuring Conditions

NOTE

- When ImpMeas starts, it acquires PLZ-5WZ's range information and uses it as parameters for measurement calculations. If you change the range, you need to restart ImpMeas.

Set the conditions necessary for impedance measurement.

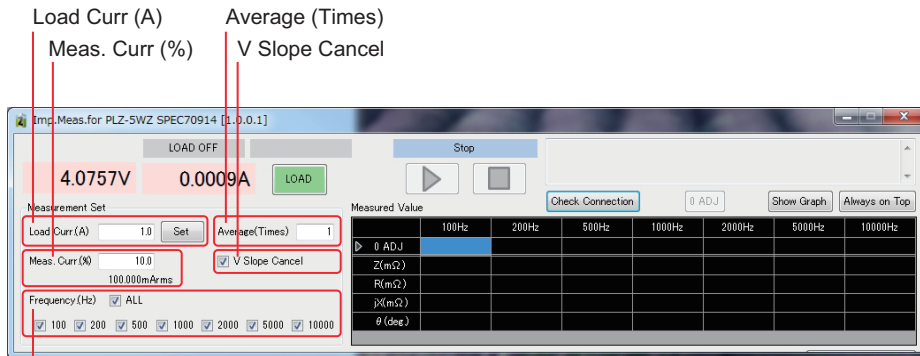

Frequency

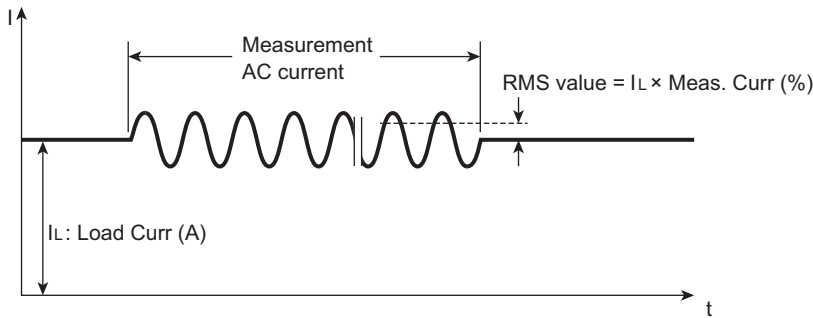

Load Curr (load current)

- Set the load current. To confirm, click Set.
Set the load current within the rated range of the current range specified on the PLZ-5WZ, and set it so that it does not exceed the rated power or the specified overpower protection (OPP).

Meas.Curr (measurement AC current)

- Set the rms value of the measurement AC current as a percentage of the load current.
The specified value (RMS) appears below the box.
During impedance measurement, the sum of Load Cur (A) and Meas.Curr (%) flows through the PLZ-5WZ. Set the rms value so that this peak value does not exceed the PLZ-5WZ's current range rating or rated power.

Example of a PLZ205WZ set to H current range (40 A rating):

Load Curr = 35 A, Meas.Curr = 10 % = 3.5 Arms = 4.95 Apeak

The current peak value that flows through the PLZ205WZ is 39.95 A (35 + 4.95).

Average (number of measurements)

- Set the number of measurements.

Measurement is repeated the specified number of times at each measurement frequency, and the measurement result is the average at each frequency.

The measurement time is equal to the time of one measurement \times average count. For example, if the average count is 16, a measurement takes 16 times the time to perform one average cycle.

Frequency (measurement frequency)

- Select the measurement frequencies using the check boxes.
If you select ALL, all measurement frequencies will be selected.
Be sure to select at least one measurement frequency.

V Slope Cancel function

- To use the V Slope Cancel function, select its check box.

As shown in the figure, the V Slope Cancel function eliminates the slope in the DUT voltage caused by the load current to prevent affecting the impedance measurement.

Because the function is for treating a voltage slope that is linear, it cannot handle drastic voltage drops or nonlinear slopes.

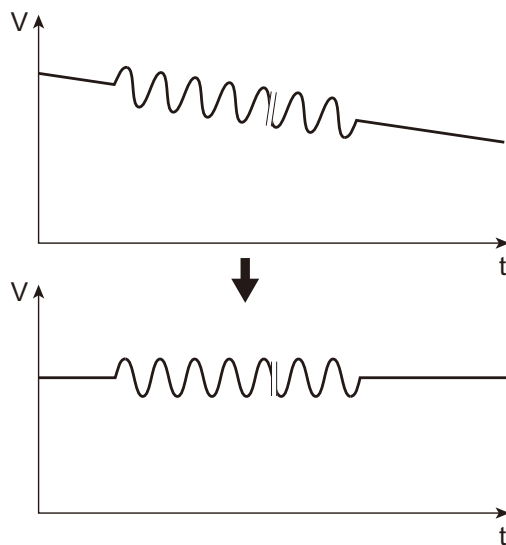

0 ADJ (Zero Adjustment)

As with typical impedance meters, measurement system offset and residual components in the measurement environment can be eliminated with zero adjustment. Perform zero adjustment after connecting the DUT to the PLZ-5WZ and setting the voltage range and current range. If you change the range, you need to perform zero adjustment again.

1 Short the sensing cables at the negative terminal of the DUT.

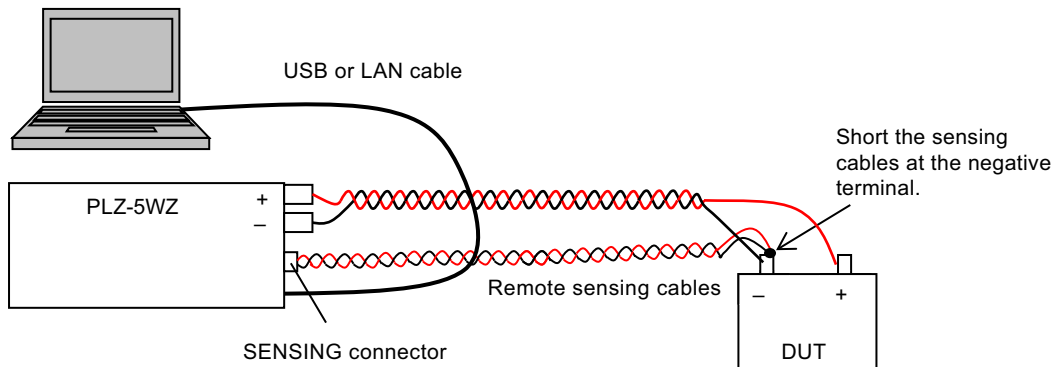

2 Set Load Curr to the same value as during measurement.

3 Set Meas Curr to the measurement AC current.

We recommend 10.0 %.

4 Select V Slope Cancel.

5 Select the measurement frequency.

Zero adjustment is performed for the selected measurement frequency. We recommend ALL.

6 Click LOAD.

“LOAD OFF” changes to “LOAD ON.”

7 Click 0 ADJ.

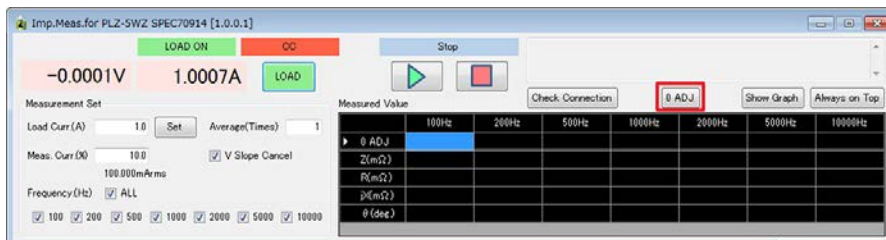

During adjustment, the status is displayed in the status display area.

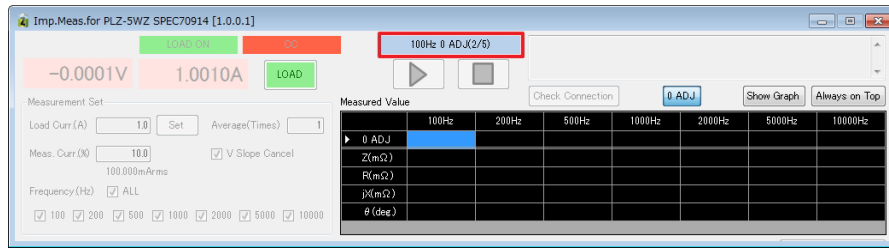

When adjustment is complete, ON is displayed in the 0ADJ cell.

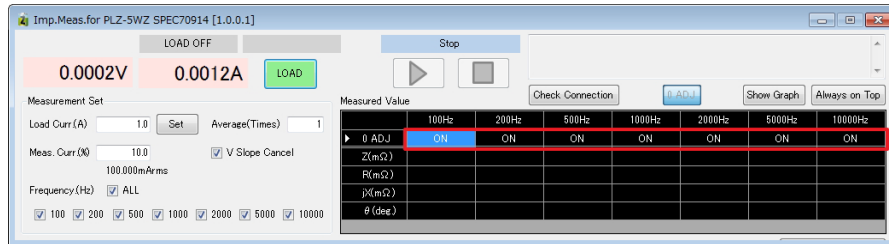

8 Connect the positive sensing cable to the positive terminal of the DUT.

Clicking 0 ADJ again clears the correction value and turns off the zero adjustment function.

Zero adjustment may not work effectively depending on the wiring condition or measurement environment. If it doesn't, turn zero adjustment off.

Measurement

Executing a Measurement

Pre-execution check

After zero adjustment, check the connection of the remote sensing cables on the DUT end (p.19). If the connection is wired for zero adjustment (p.34), measurements cannot be made correctly.

Starting a measurement

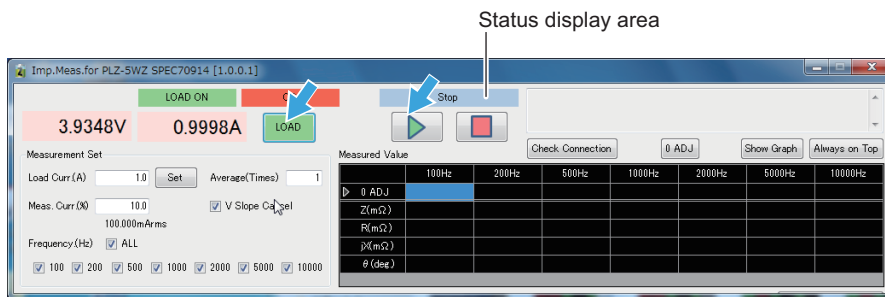

1 Click LOAD.

“LOAD OFF” changes to “LOAD ON.” The load current starts flowing.

2 Click the run button (green triangle).

The measurement starts. The time it takes to make the measurement varies depending on the measurement frequency.

The estimated time of a single measurement is about 5 s for 100 Hz, 500 ms for 1 kHz, and 50 ms for 10 kHz. (This excludes communication time. The communication time does not depend on the frequency.)

The time it takes to calculate measurement values is given by (measurement time + communication time) × average count.

During a measurement, the progress is displayed in the status display area.

■ Aborting a measurement

1 Click the stop button (red rectangle).

The measurement is aborted. “Stop” is displayed in the status display area.

■ Resuming the measurement

1 Click the run button (green triangle).

The measurement will resume.

When an alarm occurs in the PLZ-5WZ

If an alarm occurs during measurement and the PLZ-5WZ switches to load off, ImpMeas displays the following message and automatically changes to the load off state.

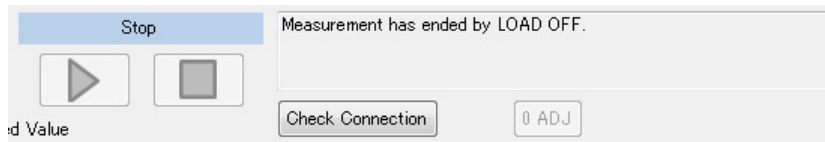

Example of a PLZ-5WZ alarm display

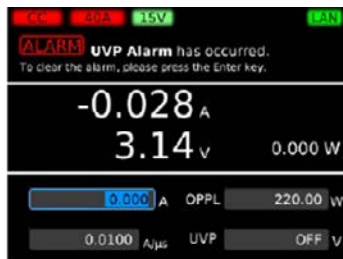

Resuming the measurement

- 1** Close ImpMeas.
- 2** Remove the cause of the alarm.
- 3** Press ENTER.
The alarm is cleared.
- 4** Start ImpMeas.

NOTE If the cause of the alarm remains, the alarm will occur again.

Measurement Results

Displaying measurement results

Measurement results are displayed in each Measured Value cell.

Measured Value	100Hz	200Hz	500Hz	1000Hz	2000Hz	5000Hz	10000Hz
0 ADJ							
Z(mΩ)	37.5	34.3	31.4	29.5	27.8	26.1	25.1
R(mΩ)	37.3	34.0	31.1	29.3	27.7	26.1	25.1
jX(mΩ)	-4.5	-4.3	-4.0	-3.5	-2.9	-1.5	-0.1
θ (deg.)	-6.9	-7.2	-7.3	-6.8	-5.9	-3.4	-0.3

Copying measurement results

By selecting cells as shown in the following figure and copying them (Ctrl+C), you can paste them (Ctrl+V) to Excel or other applications. You can select the cells as you like.

Measured Value	100Hz	200Hz	500Hz	1000Hz	2000Hz	5000Hz	10000Hz
0 ADJ							
Z(mΩ)	37.5	34.3	31.4	29.5	27.8	26.1	25.1
R(mΩ)	37.3	34.0	31.1	29.3	27.7	26.1	25.1
jX(mΩ)	-4.5	-4.3	-4.0	-3.5	-2.9	-1.5	-0.1
θ (deg.)	-6.9	-7.2	-7.3	-6.8	-5.9	-3.4	-0.3

Paste the results to an Excel sheet.

	A	B	C	D	E	F	G	H	I
1		100Hz	200Hz	500Hz	1000Hz	2000Hz	5000Hz	10000Hz	
2	Z(mΩ)	37.5	34.3	31.4	29.5	27.8	26.1	25.1	
3	R(mΩ)	37.3	34	31.1	29.3	27.7	26.1	25.1	
4	jX(mΩ)	-4.5	-4.3	-4	-3.5	-2.9	-1.5	-0.1	
5	θ (deg.)	-6.9	-7.2	-7.3	-6.8	-5.9	-3.4	-0.3	
6									
7									

Displaying the graph

Click Show Graph to display Z and θ frequency response graphs.

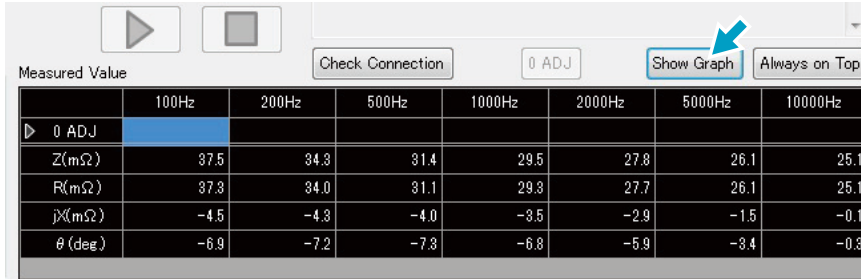

Measured Value	100Hz	200Hz	500Hz	1000Hz	2000Hz	5000Hz	10000Hz
0 ADJ							
Z(m Ω)	37.5	34.3	31.4	29.5	27.8	26.1	25.1
R(m Ω)	37.3	34.0	31.1	29.3	27.7	26.1	25.1
jX(m Ω)	-4.5	-4.3	-4.0	-3.5	-2.9	-1.5	-0.1
θ (deg)	-6.9	-7.2	-7.3	-6.8	-5.9	-3.4	-0.3

The setting conditions and measurement time (the time when all measurements are completed) are automatically inserted in the graphs.



1: Graph of Z (left)

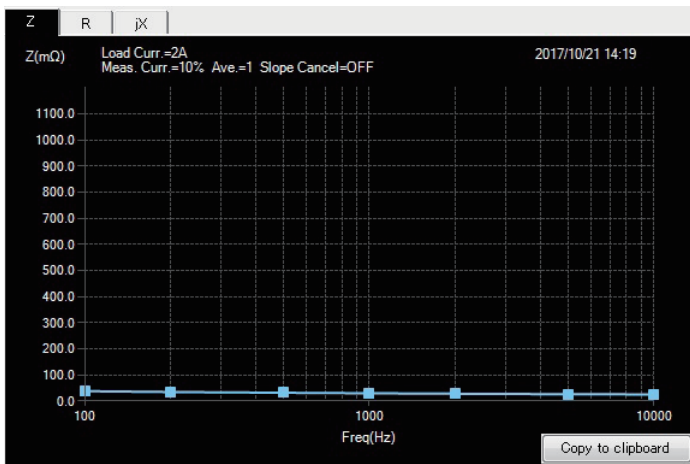

2: Graph of θ (right)

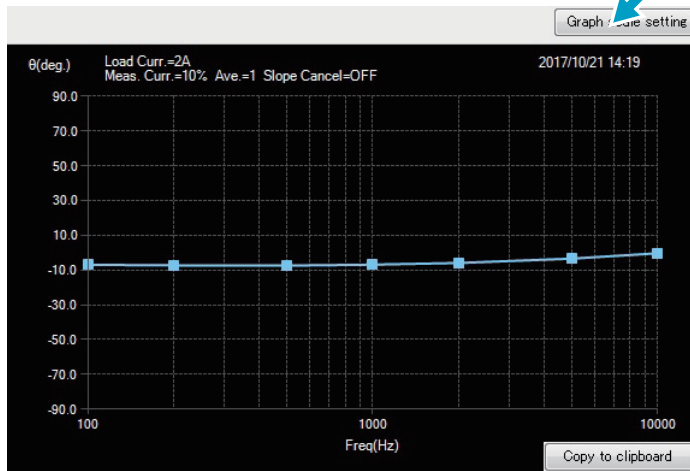

Set the X-axis and Y-axis scale of graphs.

Graph scale setting

Click the tabs to display R and jX graphs.

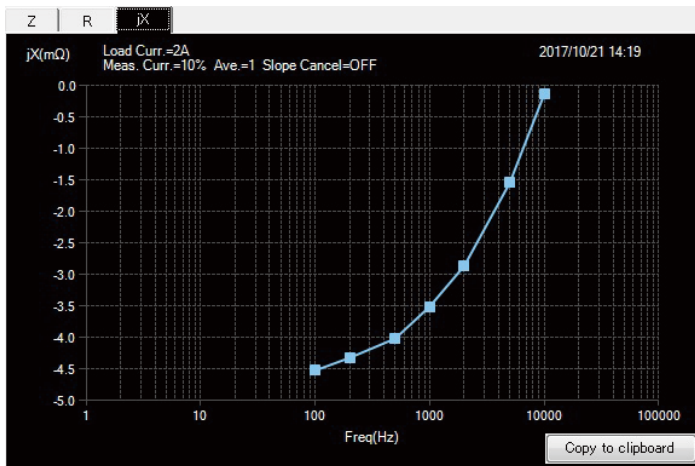

Setting the X-axis and Y-axis scale of graphs

Click Graph scale setting (p. 39) to display a Graph setting dialog box (shown below). Selecting the Auto range check box causes the scale of that item to be adjusted automatically.

When you complete the settings, click OK.

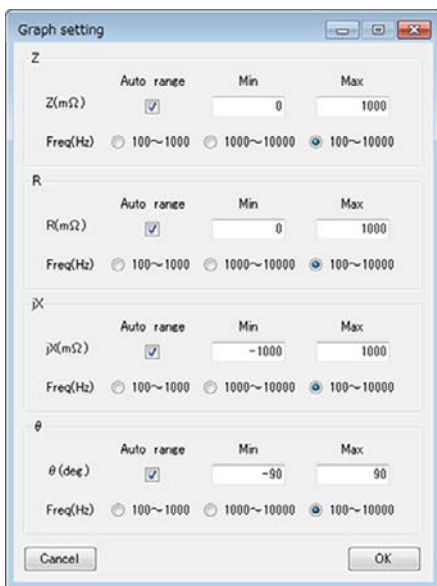

After applying Graph Scale Setting

1: Graph of Z (Min = 0, Max = 40)

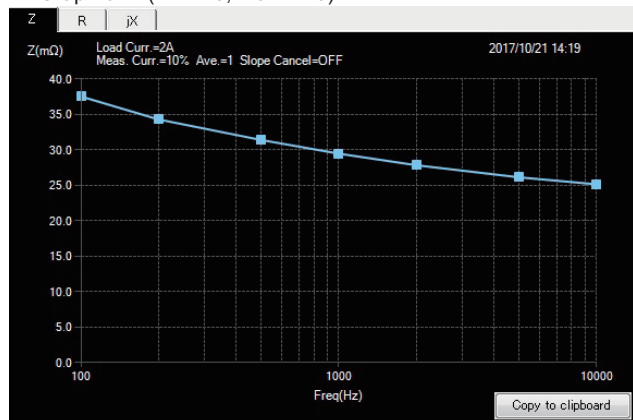

2: Graph of θ (Min = -8, Max = 0)

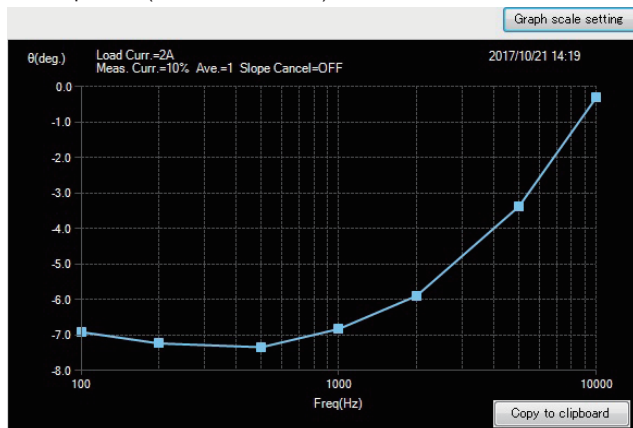

Copying a graph

If you want to copy a graph to another file, click Copy to clipboard.

Move to the file you want to paste the graph in, and paste it (Ctrl+V). (Some files may not allow pasting.)

Example: Pasting to an Excel sheet

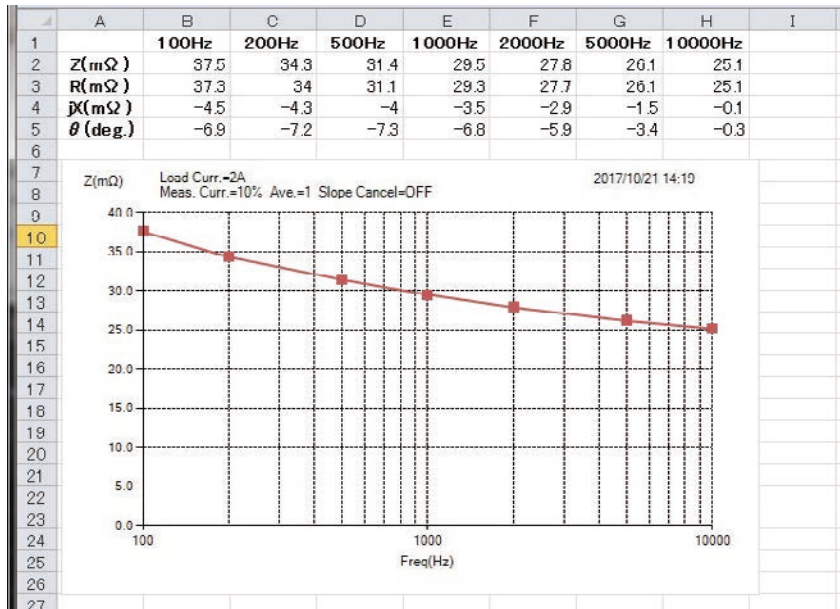

Always on Top function

Click Always on Top to keep ImpMeas the top window. This is useful when making measurements while entering data in Excel.

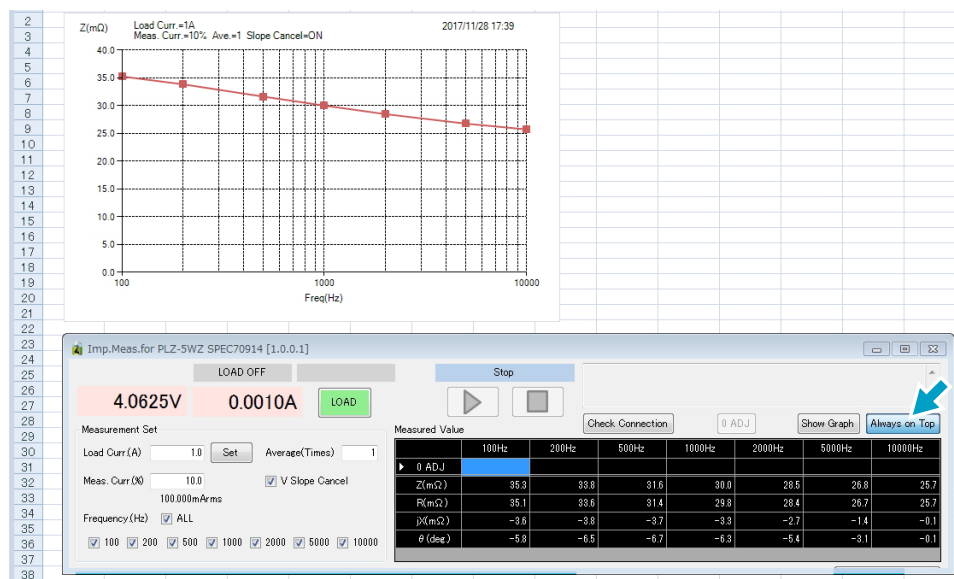

Closing ImpMeas

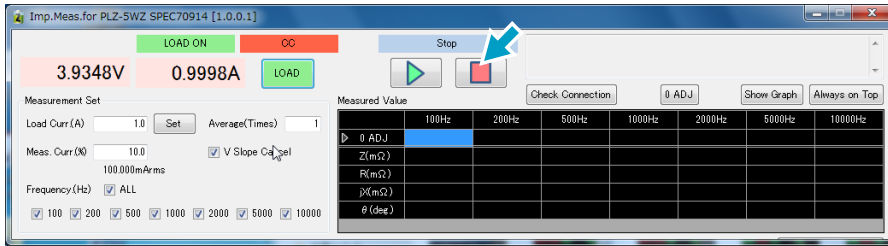

1 Click the stop button (red rectangle).

The measurement is aborted. "Stop" is displayed in the status display area.

2 Click LOAD.

"LOAD ON" changes to "LOAD OFF."

The PLZ-5WZ changes to load off.

3 Click the close (X) button.

This will close ImpMeas.

Specifications

Measurement function

Item	Description	Notes
Measurement frequency	100 Hz, 200 Hz, 500 Hz, 1 kHz, 2 kHz, 5 kHz, 10 kHz.	Seven fixed settings.
Measurement AC current	0.1 % to 10 % of the DC load current.	Set as a percentage.
Measurement time	50 ms to 5 s.	Depends on the measurement frequency.
Measurement items	R, X, Z , θ .	θ is calculated from R and X.
Measurement average	Averages 1 to 16 measured values.	
Zero adjustment (0 ADJ)	Zero adjustment on the DUT voltage sensing end.	
V Slope Cancel	Eliminates the effect that the slope of the DUT voltage caused by discharge has on measurements.	Complete elimination is not possible if the slope is non-linear.
Measurement method	2-phase lock-in amplifier method.	Based on digital computation.

Functions of Imp. Meas. for PLZ-5WZ

Item	Description	Notes
Auto measurement frequency switching	Automatically measures preset frequencies in order.	Single frequency is also possible.
Measurement graph	Z, R, jX, and θ graphs with measurement frequencies plotted on the horizontal axis.	With a graph scale adjustment function.
Simple monitor	PLZ-5WZ's voltage and current measurements, status display.	No display updating during measurements.
Copying to clipboard	Graphs and measurements (list display) are output to the clipboard.	
Window size switching	Displays measurements in a compact window when graphs are not necessary.	A switching function.
Always on Top	Displays the ImpMeas window always on top.	A switching function.

Measurement accuracy

This system superimposes measurement AC current controlled with a constant current on the load current. The DUT's AC voltage that is generated by the load current and measurement AC current is measured at high resolution in order to measure the DUT's impedance.

Load current, DUT voltage, and measurement AC current measurements depend on the accuracy of the PLZ-5WZ.

Unless specified otherwise, the measurement accuracies are for the following settings and conditions.

- Ambient temperature: 18°C to 28°C
- Warmed up time: 30 minutes
- DUT: Reference resistance
- Bias power supply: 12 V 54 Ah lead battery

At voltage range L (15 V)

Measurement range	Measurement AC current	Measurement accuracy		
		Measurement frequency		
		100 Hz, 200Hz, 500 Hz	1 kHz, 2 kHz	5 kHz, 10 kHz
1.0 mΩ to 9.9 mΩ	500 mArms or more	±(5 % of reading+0.5 mΩ)	±(5 % of reading+0.5 mΩ)	-
10.0 mΩ to 99.9 mΩ	250 mArms or more	±(5 % of reading+0.5 mΩ)	±(5 % of reading+0.5 mΩ)	-
100.0 mΩ to 1000.0 mΩ	150 mArms or more	±(2 % of reading+0.5 mΩ)	±(3 % of reading+0.5 mΩ)	-

At voltage range H (150 V)

Measurement range	Measurement AC current	Measurement accuracy		
		Measurement frequency		
		100 Hz, 200Hz, 500 Hz	1 kHz, 2 kHz	5 kHz, 10 kHz
1.0 mΩ to 9.9 mΩ	2 Arms or more	±(5 % of reading+0.5 mΩ)	±(5 % of reading+0.5 mΩ)	-
10.0 mΩ to 99.9 mΩ	500 mArms or more	±(5 % of reading+0.5 mΩ)	±(5 % of reading+0.5 mΩ)	-
100.0 mΩ to 1000.0 mΩ	250 mArms or more	±(3 % of reading+0.5 mΩ)	±(4 % of reading+0.5 mΩ)	-

- reading: Indicates a readout value of ±Z.
- Accuracy is not guaranteed outside the impedance measurement range, for current range L, or for measurement frequencies 5 kHz and 10 kHz.
- θ is calculated from R and X by Imp. Meas. for PLZ-5WZ.
- All other specifications are according to the PLZ-5W product specifications.

Appendix

How Impedance Measurement Works

- The PLZ-5WZ has a digital signal generator for sine wave generation. The measurement AC current is driven by a constant current with a sine current of a specified amplitude superimposed on the load current.
- Voltage detection and current detection are all stored in the measurement memory in sync with the measurement AC current. For every measurement AC current cycle, 1000 measurements are recorded.
- Imp. Meas. for PLZ-5WZ performs noise reduction and voltage slope correction (V Slope Cancel function) on the 1000 measurements.
- Vector resolution (2-phase lock-in amplifier principle) is performed through digital computation, and the impedance measurement is determined. Because vector resolution uses the current measurement results as phase correction information, phase lag caused by the electronic load or load cables is effectively corrected.

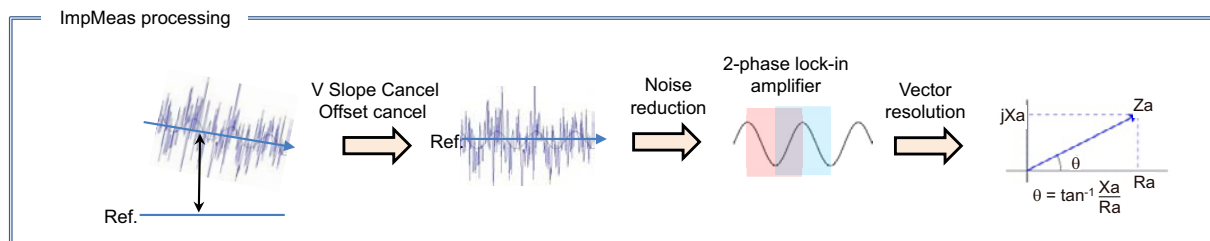
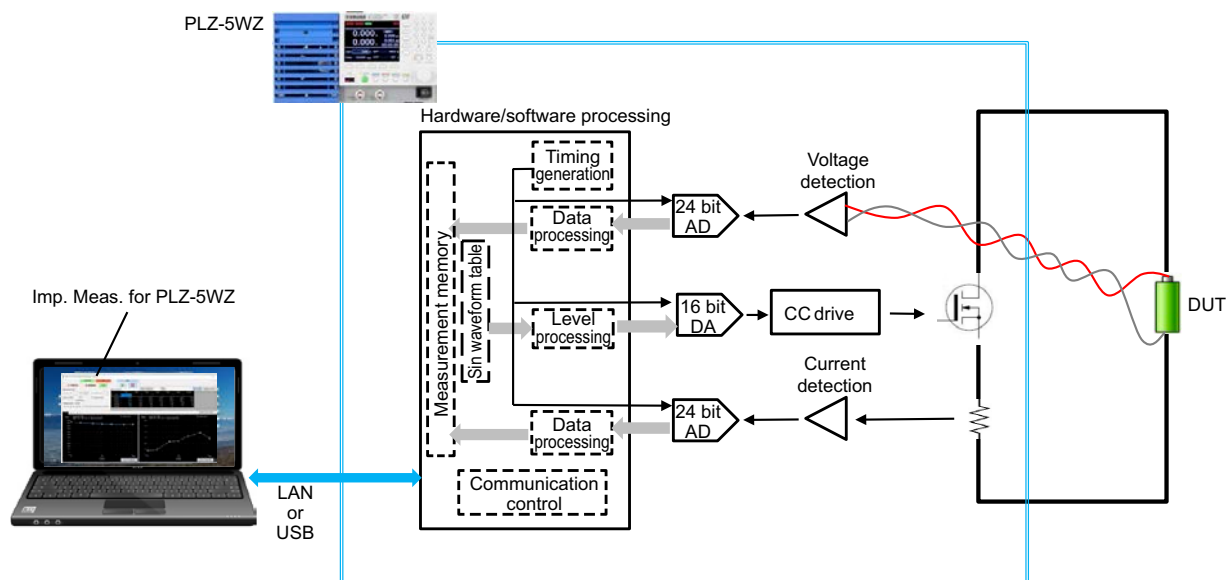

Impedance Measurement for Each Single Cell

The following figure shows the wiring for measuring the impedance of single cells connected in series in a battery pack. Connecting the remote sensing cable to the target cell enables the impedance measurement of a single cell.

The PLZ-5WZ allows a voltage difference to exist between the load input terminal and sensing terminal (voltage component other than that of the target cell) as long as the rated voltage range is not exceeded.

■ Notes on use

- The PLZ-5WZ's overpower protection (OPP) is activated based on the product of the single cell voltage and load current.
- As such, the PLZ-5WZ may operate exceeding the rated power of the PLZ-5WZ. Calculate the power consumption of the entire battery (all cells) in advance, and make sure the rated power is not exceeded.
- To minimize voltage drop in cables, wire the load cables as short as possible. (p.14)
- Set the voltage range of the PLZ-5WZ based on the V_{pack} voltage.
- The PLZ-5WZ's voltage protection function (UVP) works on the measured cell voltage.
- V_{cell} must be within the V_{pack} voltage range.
- The remote sensing cables cannot be connected to the DUT with the polarity reversed.
- By principle, measurement errors may increase when V_{cmL} is large.

PLZ205WZ connection example

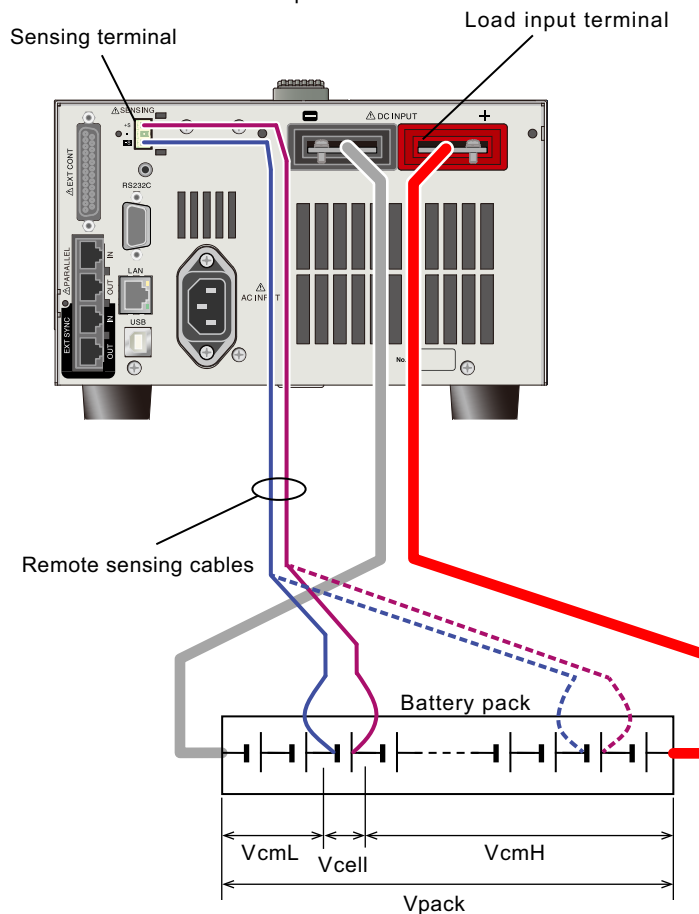

Effects of Input Impedance

Measurement AC current I_M (100 Hz to 10 kHz) is detected by R_{sh} and used in the impedance calculation. As the measurement frequency increases, the current through I_L becomes non-negligible. As such, the accuracy of impedance measurements is not guaranteed for conditions in which the measurement frequency is high (5 kHz or higher).

Input equivalent circuit

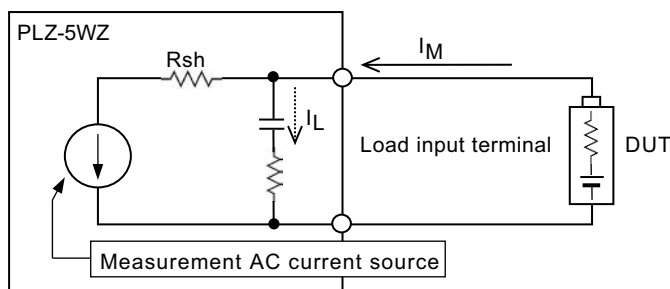

The effect on the accuracy of impedance measurements varies depending on the PLZ-5WZ input impedance, measurement frequency, and DUT impedance. The relationship is shown in the figures below.

Model-dependent characteristics

Graphs are plotted based on simulated computation using equivalent circuit models of each PLZ-5WZ model.

The vertical axis represents the measurement accuracy [%], and the horizontal axis represents the DUT impedance.

The left graph shows the measurement accuracy for Z , R , and jX , and the right graph the measurement accuracy for θ .

The accuracy [%] reading is substituted in the following equation, and the impedance measurement accuracy (reference, not guaranteed) is determined.

$$\text{Impedance measurement accuracy: } \pm(\text{Accuracy}[\%] \text{ of reading} + 0.5 \text{ m}\Omega)$$

PLZ205WZ

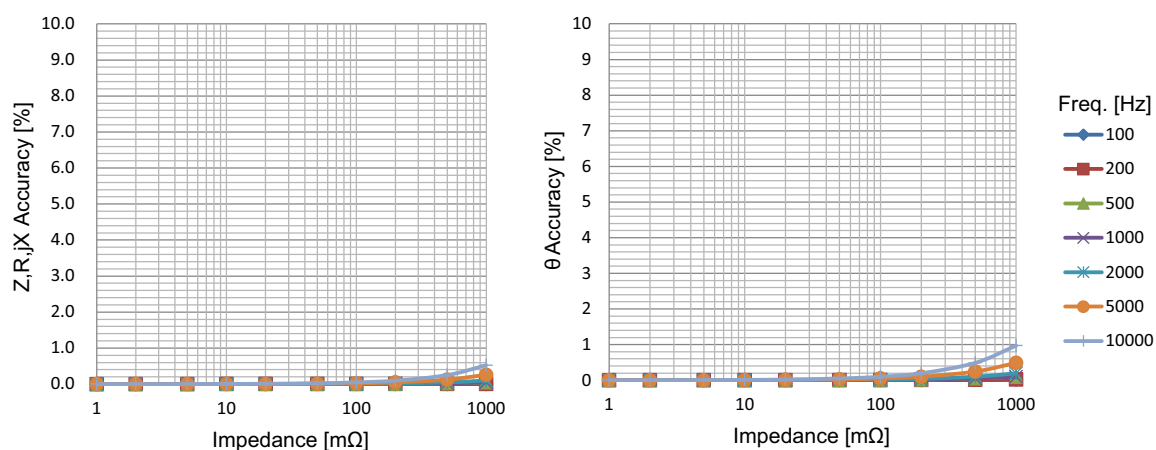

PLZ405WZ

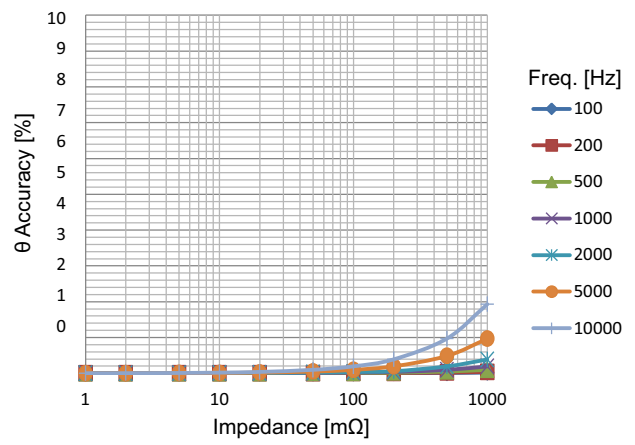
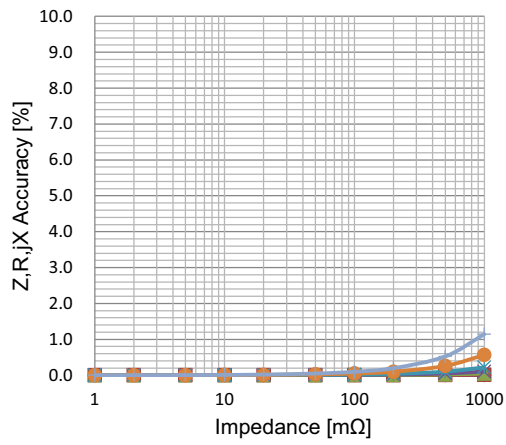

PLZ1205WZ

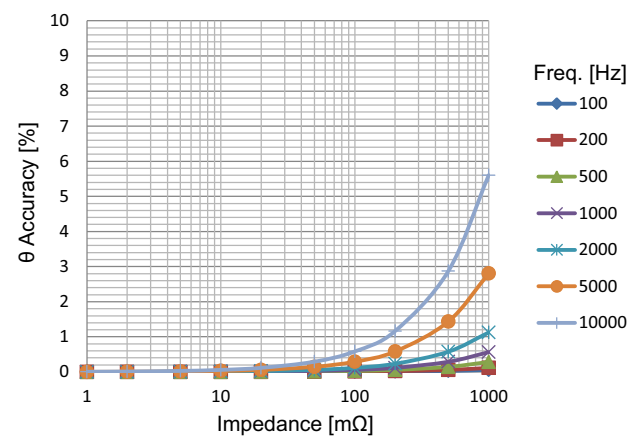
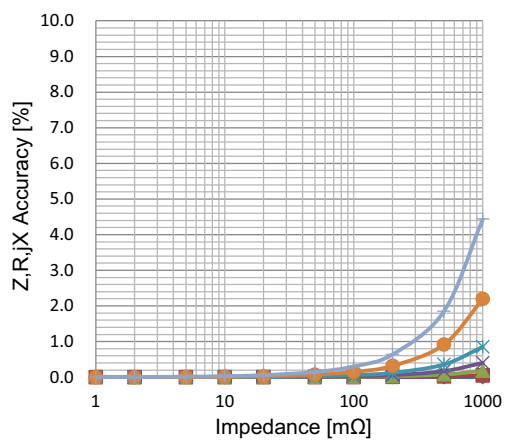

Error Messages

Error messages are displayed in a dialog box. When an error message is displayed, check the details of the error message, and perform the appropriate remedy shown below.

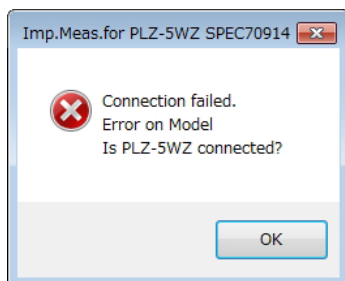

■ Connection failed. Error on Model. Is PLZ-5WZ connected?

Check	Remedy	See
Is the device that you are trying to connect a PLZ-5WZ?	Check the PLZ-5WZ serial number or IP address. Connection is not possible to a general-purpose PLZ-5W electronic load.	p.26 p.24

■ It isn't CC Mode.

Check	Remedy	See
Is the mode set to CC?	Set the mode to CC.	p.21

■ Library internal error.

Check	Remedy	See
Are sensing cables properly connected?	Connect the sensing cables properly.	p.19 p.34
Is the sensing cable broken?	Replace the sensing cable.	p.19
Is the load turned on?	Turn the load on.	p.36
Is the current displayed correctly when the load is on?	<ul style="list-style-type: none"> • Check that the load cables are connected properly. • Check that the battery (DUT) is charged. 	p.36 p.17

■ E_VISA_CONN_LOST: The I/O connection for the given session has been lost.

Check	Remedy	See
Is the USB or LAN connection correct?	Check the USB or LAN connection.	p.24 p.30

■ -222, "Data out of range: CURRENT xxxx"

Check	Remedy	See
Is Load Curr (A) outside the setting range?	Change the value within the setting range, or increase the current range.	p.32 p.21

■ **Confirm the set value.**

Check	Remedy	See
Is Meas.Curr outside the setting range?	Change the value within the setting range.	p.32

■ **Meas. Condition setting failure. (Load current value is out of range.)**

Check	Remedy	See
Is Load Curr (A) outside the setting range?	Change the value within the setting range, or increase the current range.	p.32 p.21

■ **SIN wave output off failure. (Confirm the password)**

Check	Remedy	See
Has the password been changed from the factory default value with the SYSTEM:PASSWORD:NEW command?	Enter password set by the SYSTEM:PASSWORD command.	-

■ **Measurement has ended by LOAD OFF.**

Check	Remedy	See
Is an alarm occurring on the PLZ-5WZ and the load turned off?	Temporarily close ImpMeas. Remove the cause of the alarm, and clear the alarm. Restart ImpMeas.	p.37
Are you pressing the PLZ-5WZ's LOAD key during measurement?	Do not press the key during measurement.	p.17

■ **Library internal error [Calc Theta()]. Index was outside the bounds of the array.**

Check	Remedy	See
Measurements are not correct.	<ul style="list-style-type: none"> • Check the sensing cables. • Check whether the DUT voltage or current is too small during measurement. 	p.19 p.32 p.16

Troubleshooting

This section introduces troubleshooting measures. Typical symptoms are listed. Check whether any of the items listed below apply to your case. In some cases, the problem can be solved quite easily.

If none of the items apply to your case or if following the remedy does not solve your problem, contact your Kikusui agent or distributor.

■ Communication cannot be established.

Check	Remedy	See
Is the USB or LAN connector connected?	Check that the connector is connected securely.	p.11 p.24 p.26
Is the VISA library recognizing the PLZ-5WZ?	Check that the applicable PLZ-5WZ is registered in the VISA library.	p.29
Is the serial number or IP address correct?	Check the PLZ-5WZ's SYSTEM > Information screen.	p.24 p.26

■ Completely different measurements are indicated, or the measurements are unstable.

Check	Remedy	See
Are sensing cables properly connected?	Check whether the sensing cables are broken.	p.19
Is the load current flowing?	<ul style="list-style-type: none"> • Check that the cables are connected properly. • Check that the load is on. 	p.14 p.36
Is the overpower protection (OPP) activated?	Increase the OPP value.	p.22
Is the measured current too small?	<ul style="list-style-type: none"> • Increase Meas.Curr. • Increase Load Curr. 	p.32
Is the current range setting correct?	<ul style="list-style-type: none"> • Check that the peak current is not exceeding the current range. • Set the current range to high. • Decrease Meas.Curr. • Decrease Load Curr. 	p.21 p.32

■ Measured values are abnormal after the range is changed.

Check	Remedy	See
Did you restart ImpMeas after changing the current range?	Close ImpMeas once, and restart it.	p.21

■ Normal measurements cannot be performed after zero adjustment.

Check	Remedy	See
Did you perform zero adjustment with the sensing cables shorted at the negative terminal?	Connect the positive sensing cable to the negative terminal, and perform zero adjustment in the shorted state.	p.34
Is the impedance extremely small when zero adjustment is not performed?	Measurements may become negative due to the zero adjustment correction value. If this occurs, do not perform zero adjustment.	p.34

Index

Numerics

0 ADJ 34

A

Average 33

C

CC mode 21

constant current mode 21

Contents 5

current range 21

E

Error Messages 49

F

Frequency 33

I

IP address 26, 28, 29

K

KI-VISA 7, 29

L

LAN cable 26

Load Curr 32

load input terminal cover

rear panel 17

load input terminals

rear-panel 17

M

malfunctions and causes 51

Meas.Curr 32

N

NI-VISA 7

O

OPP 22

OPPL 22

OPPT 22

overpower protection 22

P

PLZ-5WZ serial number 24

power on/off 13

POWER switch 13

R

remote sensing 19

S

-S 20

+S 20

SENSING connector 19

sensing terminal 19

single cell 46

specifications 43

status display area 36

system configuration and accessories 3

T

troubleshooting 51

U

undervoltage protection 23

USB cable 24

UVP 23

V

V Slope Cancel 33

version, checking 2

voltage range 21

If you find any misplaced or missing pages in the manuals, they will be replaced. If the manual gets lost or soiled, a new copy can be provided for a fee. In either case, please contact your Kikusui agent or distributor. At that time, inform your agent or distributor of the "Part No." written on the front cover of this manual.

Every effort has been made to ensure the accuracy of this manual. However, if you have any questions or find any errors or omissions, please contact your Kikusui agent or distributor.

After you have finished reading this manual, store it so that you can use it for reference at any time.

KIKUSUI ELECTRONICS CORP.

1-1-3 Higashiyamata, Tsuzuki-ku, Yokohama,
224-0023, Japan

Tel: +81-45-482-6353

Fax: +81-45-482-6261

www.kikusui.co.jp/en

