



# P F X 2 5 0 0 S E R I E S



## Charge/Discharge System Controller

# PFX2500 Series

Maximum voltage: 60.0000 V

Maximum current: 50.0000 A (2511,2512) / 200.0000 A (2532)

- Capable of seamless charging/discharging (high speed charging/discharging transfer control) (2512,2532)
- Capable of high-precision measurement of cumulative capacities and amount of power as well as voltage and current
- Pattern charging/discharging capabilities by 10000 steps are installed (2512,2532)
- Supporting temperature measurement and capable of monitoring temperatures during charging/discharging
- High speed sampling with maximum 1 ms can be realized (2512,2532)
- A 6 V range is newly installed and is capable of high-precision measurement (2512,2532)
- Fully equipped with safety features of the overcharge protection using voltage, electric charge and temperature
- Battery deterioration is prevented by turning off the output after detecting wobbling and shock with vibration sensor
- LAN as standard equipment (2512,2532)



# Energy Storage Essential to New Energy Application. Fully support Charge and Discharge Measurement from Basic Test to Simulation Test

The test system enables you to carry out easily for the battery simulation of the actual environment. Comprehensive Management from Test Condition Setting, Execution and Test Result Analysis can be conducted by the Exclusive Application Software

PFX2512/2532 Series is a high performance Charge/Discharge system controller that takes measurements in combination with our DC power supply and electronic load in order to evaluate test sample (electric storage elements such as secondary batteries) characteristics. It is also capable to perform evaluation test with high-performance, large capacity and wide range of rating with the combination of DC power supply and electronic load. Execution of the test is conducted by the exclusive application software. The test corresponds to long time continuous test and synchronization test with temperature chambers with the multiplexed protection performance. In addition, easy data editing is also capable with fulfilling graphic performance.



■ Application software  
BPChecker3000  
[SD007-PFX]

▲ Configuration(example) \*PC is provided by users.  
Multi Range DC Power Supply PWR800L(upper left), DC Electronic load PLZ1004W(lower)

## Charge/Discharge System Controller

# PFX2512/2532

Examples of Applications



PFX2512



PFX2532 **NEW**

Item	PFX2532 <b>NEW</b>	PFX2512
Rating	60 V / 200 A	60 V / 50 A
Application software	BPChecker3000	
Communication interface	LAN	
Monitoring data minimum time interval	0.1 s	
High speed data sampling	Selected form 1 ms/10 ms/100 ms. Maximum 6000 points for every profile.	
Charge/discharge mode	12 modes Charging: CC, CC-CV(Cell CV Voltage)*1 Discharging: CC, CP, CC-CV(Cell CV Voltage)*1, CP-CV(Cell CV Voltage)*1 Others: Pattern(CC, CP, Cell CV Voltage*2, I-V, Pause	
Test condition configuration	Individual Profile Setting (unlimited) for Charging/Discharging, etc Conditional branching function from charge/discharge results is available.	
Seamless charge/discharge	Less than 50 ms for transfer time.	
Termination condition	Temperature condition.	

\*1 Can be set only when the optional OP02-PFX Volt/Thermometer Unit or OP03-PFX Voltmeter Unit is installed.

\*2 Can be set only when the optional OP02-PFX Volt/Thermometer Unit or OP03-PFX Voltmeter Unit is installed. Step time can be used in more than 500 ms.

## Complicated Systems Integrated into One

PFX2512/2532 Series has integrated systems into one unit where battery evaluation is required. In addition, the series has high degrees of flexibility corresponding to wide range of rating since it is possible to combine our conventional DC power supply (for charging) and our electronic load (for discharging) tailored to needs. Introduction cost is able to be reduced by selecting equipment which meets charge/discharge test condition required.

### ● System Conceptual Diagram

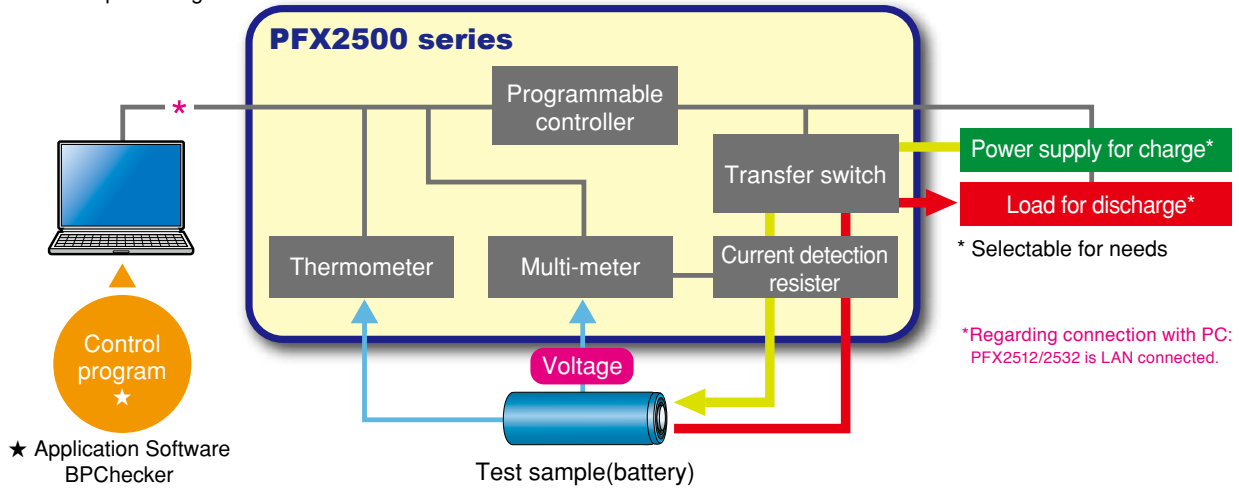

## Easy Configuration

It is possible to configure the system by yourself. The DC power supply and electronic load that are applied configuration with PFX2512/2532, can be used for the system. This allows you to have a test system at low cost. \* For details, please refer to system configuration on page 5 and the list of applied configuration and options on page 18.

## Control of the Constant Current (CC) and Constant Voltage (CV)

The digital CC and CV control method is adopted to minimize the difference between the setting accuracy and the drift characteristic of constant current (CC) /constant voltage (CV) genera and the electronic load, and it can apply for the precise evaluation. Any of the adjustment are not required after the system configuration.

## Precise Measurement

The high-precision measurement circuit is equipped. It detects the battery voltage and the charge and discharge current in high accuracy. (Measurement resolutions: 100  $\mu$ V and 100  $\mu$ A, Elapsed time measurement: within 10 ppm)

Measurement on actual power amount and accumulated capacity is also capable even for the pulse current difficult to be captured.

## Protection Functions for Safety Operation

Equipped with protection functions provided by hardware and software against phenomena such as overcharge and overdischarge. The route switch (load switch) is built in the PFX2500 series and it equips with a function to ensure connection between the DUT (batteries) and the DC power supply/electronic load as well as a high-speed interruption function that promptly disconnects the DC power supply/electronic load in case any abnormal state is detected. In addition, the vibration sensor detects major vibration and shock in case of a disaster or accident during charge and discharge test, then shuts off the output, and it prevents a damage to the connected equipment and the DUT (batteries).

## Up to 10000 Steps for Pattern Charge/Discharge

It is capable to set the CC/CP (with V, I limit) step values up to 10000. Complicated charge/discharge test with minimum 100 ms step of time window since high speed charge/discharge transfer control becomes functional. This widely corresponds to the generation of test patterns or simulation patterns for various specification tests.

# FOR BATTERY TEST SYSTEM PFX2500 SERIES

## Capable of Expanding Measurement Function

Measurement points, 4 points for voltage and 4 points for temperature, are able to be added by installing optional voltage/temperature Unit, OP02-PFX. Since there are 3 slots for optional board, measurement point addition is capable up to 12 points for voltage and 12 points for temperature as maximum.

By installing an Voltmeter Unit OP03-PFX in an option slot on the SL01-PFX<sup>\*1</sup>, you can increase the number of voltmeter measurement points. If OP03-PFX units are installed in all option slots of the SL01-PFX<sup>\*1</sup>, voltage measurement points can be expanded to 64 points.

<sup>\*1</sup> OP02-PFX cannot be installed.

When using the option "SD01-PFX", one of the internal expansion slot of PFX2353/2512 will be used.

### ■ Rear Panel (PFX2512)

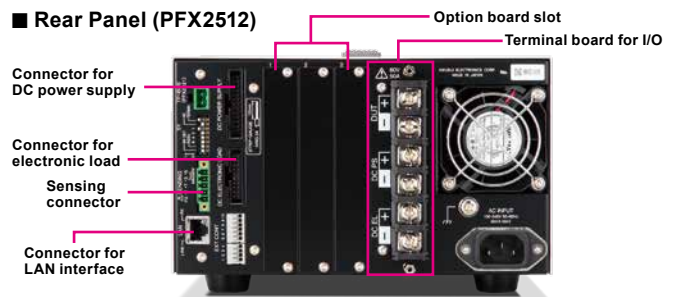

### ■ Rear Panel (PFX2532)

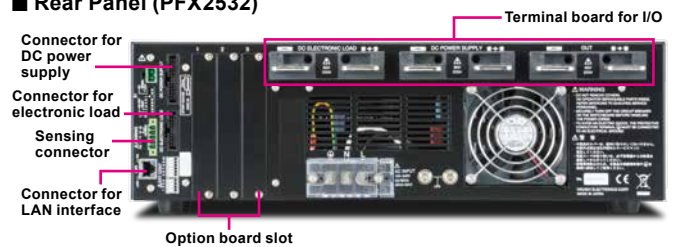



## Corresponding to Specification Test Pattern by Realizing Seamless Charge/Discharge

A certain time was required for transferring power supply and electronic load in the past. Seamless charge/discharge transfer has been realized at PFX2512/2532 by the simultaneous control of power supply and electronic load. For this reason, correspondence to characteristic test of recapturing complex applications such as application where charge/discharge repeating without taking breath is performed for electric motorcycle and electric assisted bicycle as well as electric vehicle and hybrid vehicle, and application for UPS for peak shift and to specification test pattern where continuous charge/discharge is performed such as IEC62660 became possible.

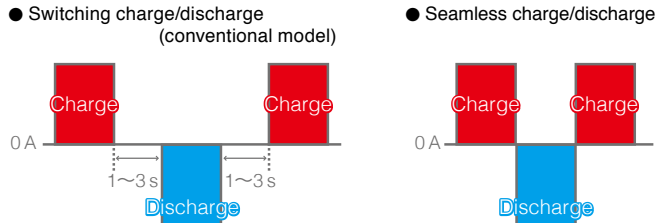

● EV/HEV cycle test pattern (example)

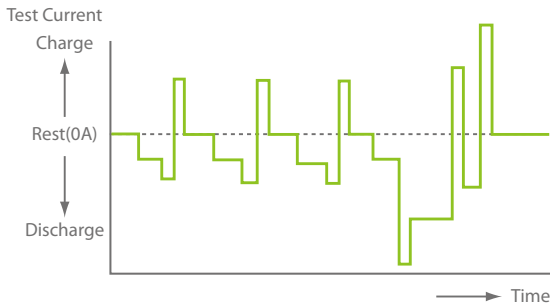

[Pattern Charge/Discharge]

Setting condition

2 values CC pattern charge/discharge

Step 1	CHG: 200 A 500 ms
Step 2	DISCH: -200 A 500 ms

● Pattern current waveform (example)

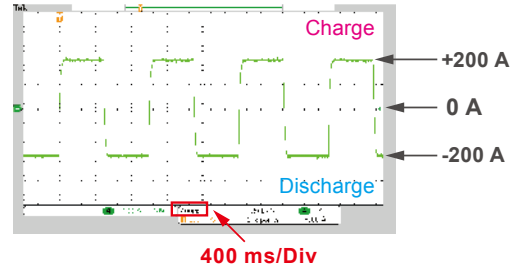

● The rising/falling wave forms of the pattern current (example)

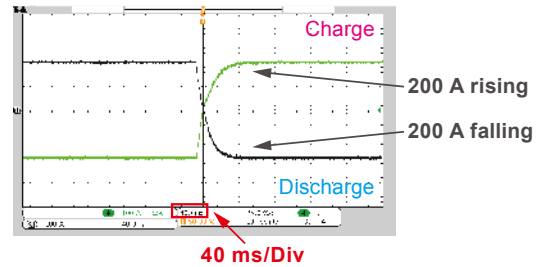

### Realized Maximum 1 ms High Speed Data Sampling

Minimum 1 ms (maximum 6000 points for every profile) voltage/current measurements are capable by assigned voltage and current steps as trigger. This is most suited to impedance analysis of test and evaluation of life determination since high-precision voltage waveform synchronized to step current can be acquired.

- ▶ Sampling rate: selected from 1 ms/10 ms/100 ms
- ▶ Cell voltage meter: fixed at 100 ms of sampling rate (at OP02-PFX installed)
- ▶ 4 types of measurement start triggering (just after charge- discharge start/just before charge-discharge completion)
- ▶ 6000 sampling storage: 6 s @1 ms/60 s @10 ms/ 600 s @100 ms

● Pattern profile  
Trigger point setting example (case of negative sign delay time)

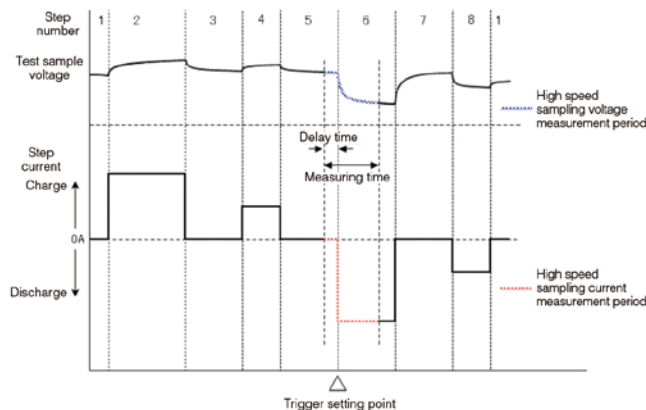

### More Accurate Single Cell Evaluation with 6V Range

PFX2512/2532 equips Voltage Range transfer capability between 6 V and 60 V. A 6 V range was newly installed in PFX2512/2532 in order to perform evaluation more accurately even for a single cell. 6 V range accuracy =  $\pm (0.05 \% \text{ of rdng} + 0.04 \% \text{ of f.s})$ , 60 V range accuracy =  $\pm (0.05 \% \text{ of rdng} + 0.02 \% \text{ of f.s})$ . In addition to the stacked cell assembly, more accurate characteristic test is capable with single cell.

### Applied to CAN interface

PFX2512/2532 (BPChecker3000) is able to communicate with exclusive application where communication log, analysis, emulation functions, etc, are added. Herewith, it becomes possible corresponding to various demands such as synchronization between charge/discharge control and log segment, charge/discharge control from exclusive application. For details, please refer to page 6 and 7.

## Descriptions of Charge/Discharge Test

With the PFX2512/2532, various electrical characteristic tests are able to be performed regardless battery manufacturer or customers.

- I-V Characteristics Test
- Cycle Characteristics Test
- Charge/Discharge Rate Test
- Temperature Characteristics Test
- Charge/Discharge Efficiency Test
- Capacitance Measurement Test
- Storage Characteristics Test
- Capacitance Change Test
- Actual Load Simulation Test
- BMS Validation Test

## FOR BATTERY TEST SYSTEM PFX2500 SERIES

### System Configuration

[2532 System Configuration example]  
(model ID : 7303)

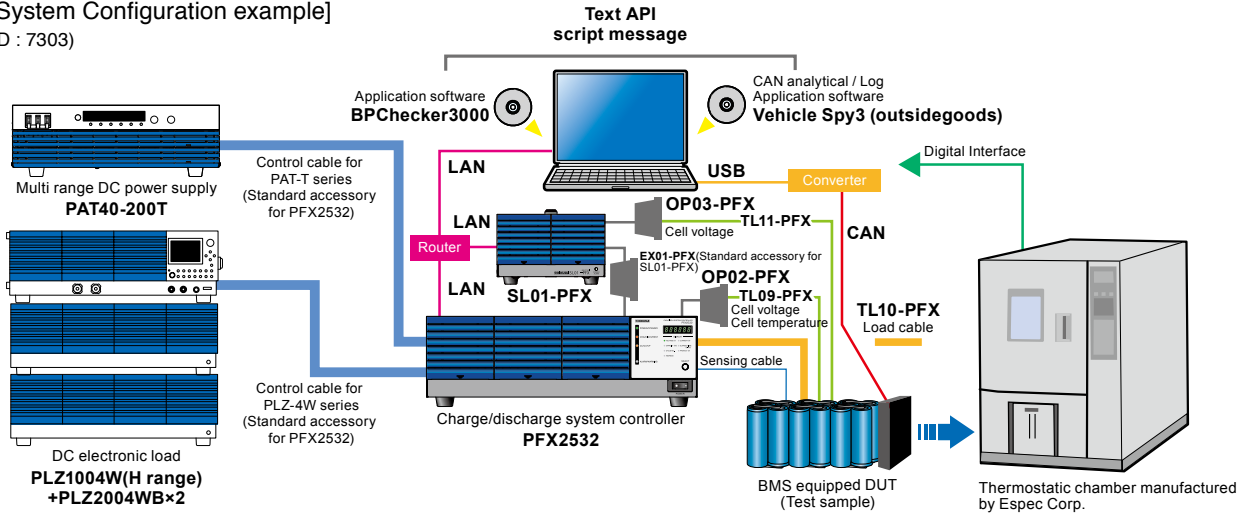

- Multi range DC power supply ..... PAT40-200T
- DC electronic load ..... PLZ1004W
- Electronic Load Booster ..... PLZ2004WB
- Charge/discharge system controller ..... PFX2532
- 8Slot Unit ..... SL01-PFX
- Voltmeter Unit ..... OP03-PFX
- Application software ..... BPChecker3000
- Voltage/thermometer unit ..... OP02-PFX
- Sensing Cable(for OP02-PFX) ..... TL09-PFX
- Load Cable(20 A, 3 m) ..... TL10-PFX
- Sensing Cable(for OP03-PFX) ..... TL11-PFX

- Personal computer.....Windows 7 or Windows 8.  
Display resolution: 1280 × 1024 or more  
Equipped with 10 Base T(or higher model) LAN interface
- Thermostatic chamber....Supports synchronized operation with temperature chambers.  
To perform synchronized operation, temperature chambers equipped with a communication function, manufactured by ESPEC and the associated components are required. For details, please consult with us.

[2512 System Configuration example]  
(model ID : 7101)

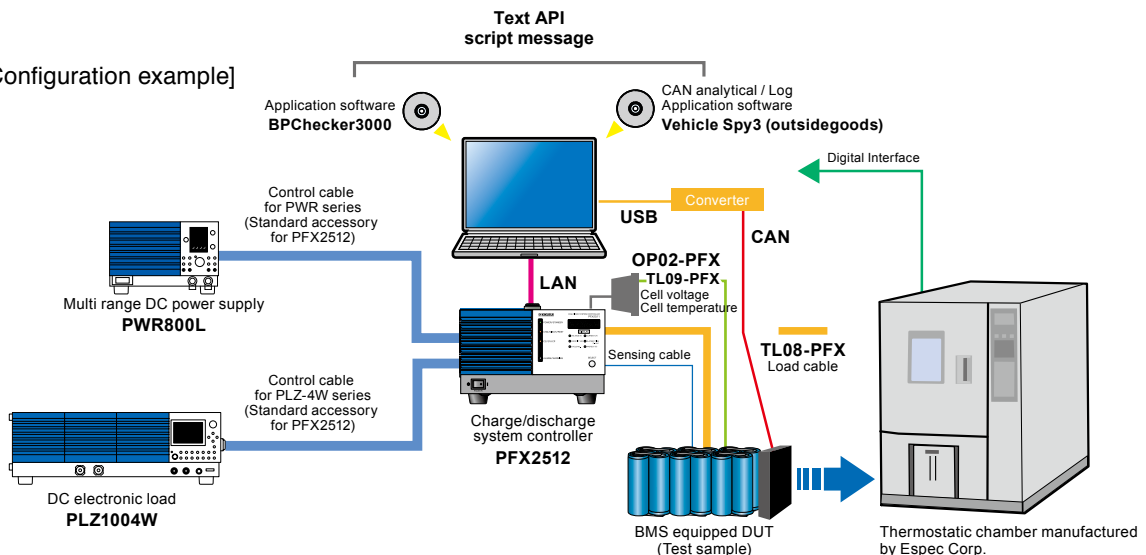

- Multi range DC power supply ..... PWR800L
- DC electronic load ..... PLZ1004W
- Charge/discharge system controller ..... PFX2512
- Application software ..... BPChecker3000
- Voltage/thermometer unit ..... OP02-PFX
- Sensing Cable(for OP02-PFX) ..... TL09-PFX
- Load cable(50 A, 5 m) ..... TL08-PFX

- Personal computer.....Windows 7 or Windows 8.  
Display resolution: 1280 × 1024 or more  
Equipped with 10 Base T(or higher model) LAN interface
- Thermostatic chamber....Supports synchronized operation with temperature chambers.  
To perform synchronized operation, temperature chambers equipped with a communication function, manufactured by ESPEC and the associated components are required. For details, please consult with us.

# PFX2512/2532 Exclusive Application Software, BPChecker3000

## Comprehensive management from test condition setting to execution and data analysis on test results by PFX2512/2532 exclusive application software, BPChecker3000



▲ Program structure  
This software consists of four programs.

The application software, BPChecker3000 (SD007-PFX), equips with the new features of PFX2512/2532 where test condition and graphical drawing function are emphasized on existing BPChecker2000, and it realizes [Seamless Charge/Discharge] and [High Speed Data Sampling]. At the test condition setting, the test condition (project) is created from database compiled charge/discharge condition (profile). The test execution shows that graphical display function is emphasized in its extraction and overwriting functions for larger data integration. In addition, synchronized operation with a temperature chambers is capable and the charge/discharge test is comprehensively controlled including temperature control under test environment. Further more, it can be applied to the operation with [CAN Bus] for which demand will be increased accompanied by the technical development of battery management in future.

**[Caution]** BPChecker3000 is essential for PFX2512/2532 performance. PFX2512/2532 does not work with BPChecker2000.

### ● Program Structure

#### Test Condition Editor

This program is used to create and edit all of test conditions related to charge/discharge testing. After profile creation, sequence and total settings, etc, are performed to create a project. BPChecker3000 executes the test by the project.

Preparation of profile (detailed conditions for charge/discharge)

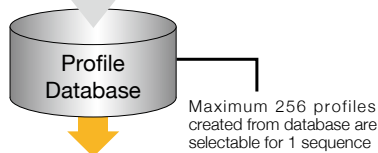
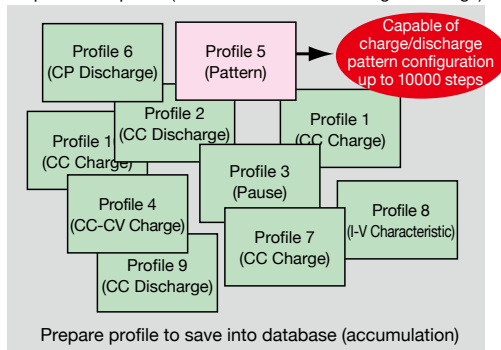

Preparation of project (test condition)

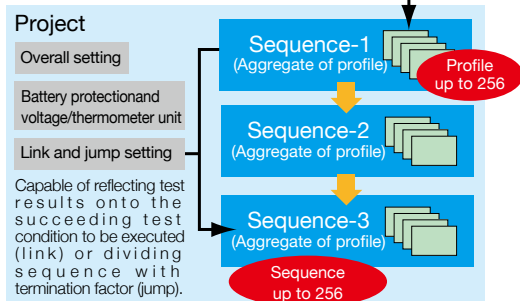

- **Capable of setting battery temperature termination conditions (rest temp)**  
For stop time setting, it is capable to set termination conditions by battery temperature in addition to time setting (fixed time) determined after charge.
- **Pause function installed**  
There is the pause function among profile types. Test is able to be paused by using this function.

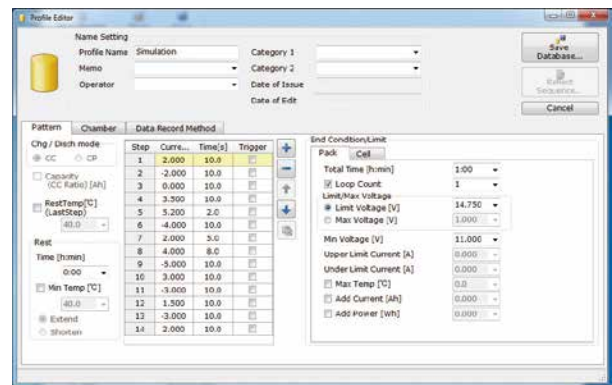

▲ Preparation of profile

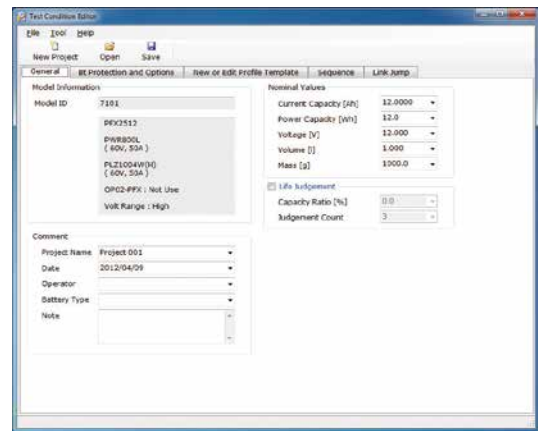

▲ Setting total project

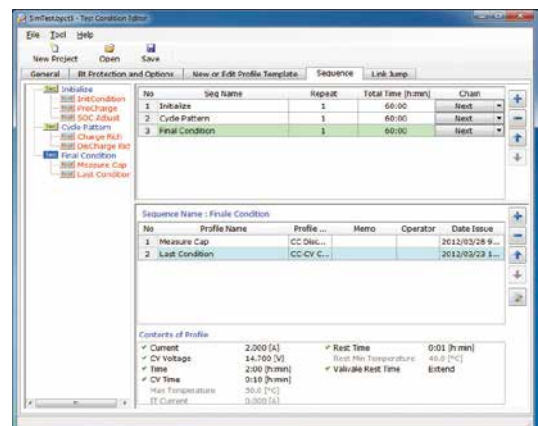

▲ Sequence setting

# FOR BATTERY TEST SYSTEM PFX2500 SERIES

## Test Executive

This program executes charge/discharge tests according to the test condition file created using the Test Condition Editor.

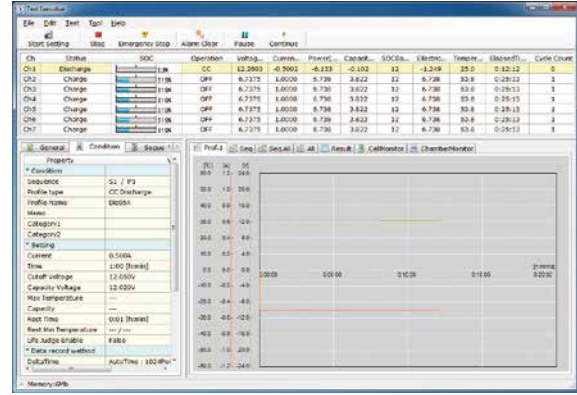
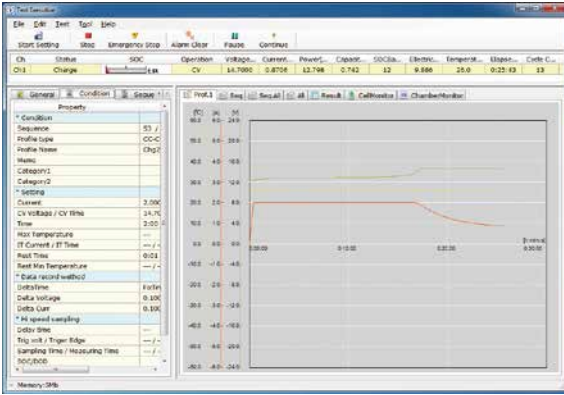

## Graph Viewer

This program is used to display the graph of test data on the screen and print the graph. When the Graph Viewer is used, overall analysis is capable to display the calculated value acquired from the test data, and from test data for energy, etc, test conditions in addition to test data graph. The Graph Viewer also able to display overlapped graphs where multiple numbers of graphs are on the screen into one.

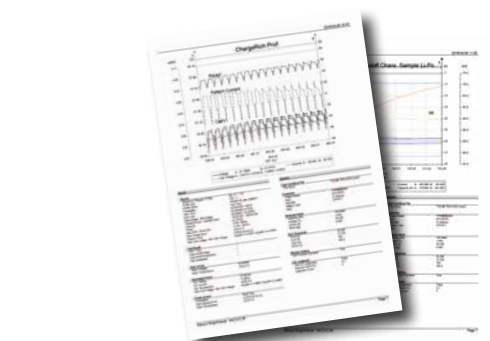
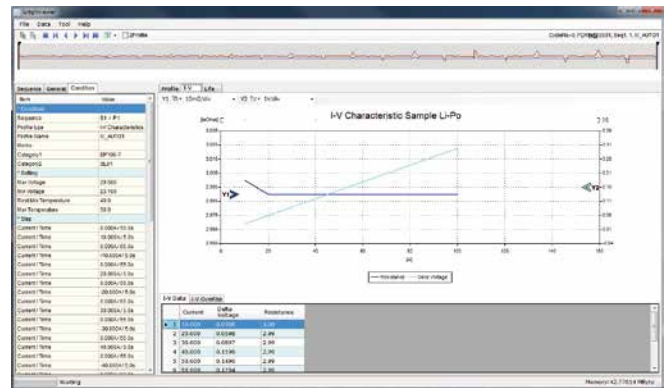
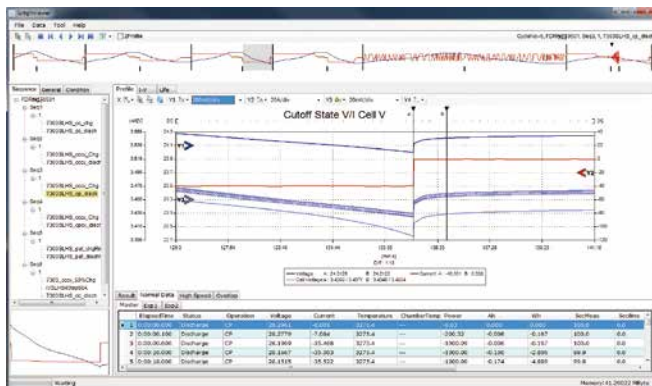
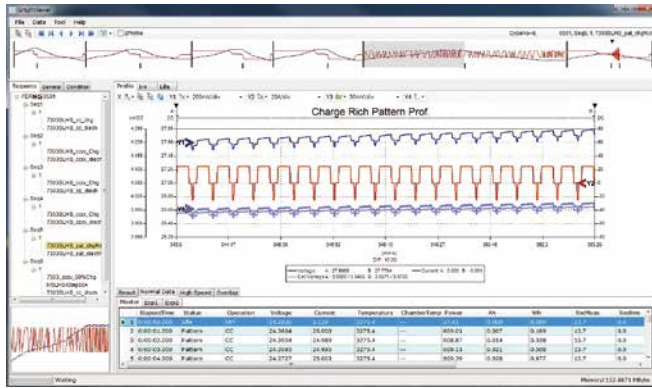

[Recommended operating environment]

- OS: Windows 7, Windows 8.2
- Memory: 4 GB or more
- HD drive: 1 GB or more of free hard disk space (the amount of additional space that is needed depends on the type of data you need to save)
- CD-ROM drive: Required for installing the applications
- Mouse or other pointing device
- Display resolution: 1280 × 1024 (17 inch) or more
- Equipped with 10 Base T (or higher model) LAN interface
- Printer: Compatible with windows
- The thermostatic chambers that can be controlled via Espec Corp.'s protocol converter/USB-RS485 converter
- VISA library: NI-VISA 3.3 or later, Agilent I/O Libraries Suite 15.0 or later, or KI-VISA 3.1.3 or later



# Specifications

## Rated Output

		PFX2512	PFX2532
Number of output		1 ch	1 ch
Charging current range *1		0.000 A to 50.000 A	0.000 A to 200.000 A
Charging voltage range *1	60 V range	0.000 V to 60.000 V	0.000 V to 60.000 V
	6 V range	0.000 V to 6.000 V	0.000 V to 6.000 V
Discharge current range *1		0.000 A to 50.000 A	0.000 A to 200.000 A
Discharge voltage range *1 *2	60 V range	0.000 V to 60.000 V	0.000 V to 60.000 V
	6 V range	0.000 V to 6.000 V	0.000 V to 6.000 V

\*1 Range might be different depending on power supply to be connected, model of electronic load, wiring situation, etc.

\*2 Lowest dischargeable voltage might be different depending on electronic load model to be connected, wiring situation, etc.

## Setting Accuracy

		PFX2512	PFX2532	
Static				
Constant current charge/discharge	Range *1	0.000 A to 50.000 A	0.000 A to 200.000 A	
	Accuracy *2	*3	*3	
	Resolution	1 mA	1 mA	
Constant voltage charging	Range *1	60 V range 0.000 V to 60.000 V	0.000 V to 60.000 V	
	6 V range	0.000 V to 6.000 V	0.000 V to 6.000 V	
	Accuracy *2	*3	*3	
Constant cell voltage Charge/discharge *9	Range *1	0.000 A to 20.000 V	0.000 A to 20.000 V	
	Accuracy *2	*3	*3	
	Resolution	1 mV	1 mV	
Constant power discharging	Range *1	0.10 W to 3000.00 W	1 W to 12000 W	
	Accuracy *2 *4	± (0.5 % of set + 1 W) *7	± (0.5 % of set + 1 W) *7	
	Resolution *5	10 mW	1 W	
Pulse				
Constant current discharging	Range	-	-	
	Accuracy	-	-	
	Resolution	-	-	
	Number of settings	-	-	
	Time width	Range	-	-
		Accuracy	-	-
Resolution		-	-	
Constant power discharging	Range	60 V range 6 V range	-	
	Accuracy	-	-	
	Resolution	60 V range 6 V range	-	
Pattern *8	Number of settings	-	-	
	Time width	Range	-	
		Accuracy	-	
		Resolution	-	

		PFX2512	PFX2532	
Pattern constant current	Range *1	-50.000 A to 50.000 A	-200.000 A to 200.000 A	
	Accuracy *2	*3	*3	
	Resolution	1 mA	1 mA	
	Number of settings	10000 values (Maximum number of steps)	10000 values (Maximum number of steps)	
	Time width	Range	0.1 s to 9999.9 s (Time width for 1 step)	0.1 s to 9999.9 s (Time width for 1 step)
		Accuracy *2	± (0.05 % of set + 10 ms)	± (0.05 % of set + 10 ms)
Resolution		100 ms	100 ms	
Pattern constant power	Range *1	-3000.00 W to 3000.00 W	-12000 W to 12000 W	
	Accuracy *2	± (0.5 % of set + 1 W) *7	± (0.5 % of set + 10 W) *7	
	Resolution	10 mW	1 W	
	Number of settings	10000 values (Maximum number of steps)	10000 values (Maximum number of steps)	
	Time width	Range	0.1 s to 9999.9 s	0.1 s to 9999.9 s
		Accuracy *2	± (0.05 % of set + 10 ms)	± (0.05 % of set + 10 ms)
Resolution		100 ms	100 ms	

\*1 Range might be different depending on DC power supply to be connected, model of electronic load, wiring situation, etc.

\*2 Ambient temperature at 18 °C to 28 °C

\*3 External equipment is controlled so as to Measurement Value being equal to Set Value by the software control.

\*4 60 V range = At battery voltage above 5 V, 6 V range = at above 0.5 V

\*5 Voltage activation range for constant power discharge: 5 V to 60 V (assured value)

\*6 Measure time after setting trigger at the half position (1/2) of pulse width (current amplitude)

\*7 With battery voltage of 2 V or more. The battery voltage is measured, and the control current (constant current control) is calculated from the set power value through software calculation. The time required to process one calculation (from the voltage measurement to the output setting) is approximately 1 ms.

\*8 The operating voltage range is 1 V or more (when the TL08-PFX is being used; regardless of whether a bias power supply is being used).

\*9 Can be set only when the optional Volt / Thermometer Unit OP02-PFX or OP03-PFX Voltmeter Unit is installed.

Unless specified otherwise, the specifications are for the following settings and conditions.  
 \* The warm-up time is 30 minutes. \* TYP (typical) values do not guarantee the performance.  
 \* "reading" Indicates the readout value. \* "set" Indicates the setting value. \* "rating" Indicates the rated. \* "Static" General term to indicate CC charge, CC-CV charge, CC discharge, CC-CV discharge, CP discharge, and CP-CV discharge \* "Pattern" General term to indicate pattern charge/discharge and I-V characteristics charge/discharge

## Measurement Accuracy

		PFX2512	PFX2532
Static			
Charge / discharge current measurement	Range *1	0.0000 A to 50.0000 A	0.0000 A to 200.0000 A
	Accuracy *2 *3	± (0.15 % of reading + 0.02 % of rating)	± (0.2 % of reading + 0.1 % of rating)
	Resolution	0.1 mA	1 mA
Voltage measurement	Range	60 V range	-6.0000 V to 60.0000 V *4
		6 V range	-1.0000 V to 6.0000 V *5
	Accuracy *2 *3 *6	60 V range	± (0.05 % of reading + 0.02 % of rating)
		6 V range	± (0.05 % of reading + 0.04 % of rating)
	Resolution *6	0.1 mV	0.1 mV
	Power measurement	Range	0.000 W to 3000.000 W
Accuracy		Software calculation (voltage measurement 5 current measurement)	Software calculation (voltage measurement 5 current measurement)
Resolution		1 mW	100 mW
Capacity calculation	Range	0.000 Ah to 2000.000 Ah	0.000 Ah to 2000.000 Ah
	Accuracy *2 *3	Rely on the current measuring accuracy and the time accuracy	
	Resolution	1 mAh	1 mAh
Time *7	Accuracy *2 *8	±10 ppm (TYP values)	±10 ppm (TYP values)
	Pulse		
Charge / discharge current	Range	-	-
	Accuracy	-	-
	Resolution	-	-
	Measured value	-	-
Battery voltage	Range	-	-
	Accuracy	-	-
	Resolution	-	-
	Measurement	High voltage	-
Low voltage		-	-
Arbitrary		-	-
Capacity calculation	Range	-	-
	Accuracy	-	-
	Resolution	-	-
Time	Accuracy	-	-
	Pattern		
Charge / discharge current	Range *1	-50.0000 A to 50.0000 A	-200.0000 A to 200.0000 A
	Accuracy *2	± (0.2 % of reading + 0.03 % of rating)	± (0.2 % of reading + 0.1 % of rating)
	Resolution	0.1 mA	1 mA
	Measured value	Average current, Update a data per period of 1 s	Average current, Update a data per period of 1 s
Voltage measurement	Range	60 V range	-6.0000 V to 60.0000 V *4
		6 V range	-1.0000 V to 6.0000 V *5
	Accuracy *2 *6	60 V range	± (0.05 % of reading + 0.02 % of rating)
		6 V range	± (0.05 % of reading + 0.04 % of rating)
	Resolution *6	0.1 mV	0.1 mV
	Power measurement	Range	-3000.000 W to 3000.000 W
Accuracy *2		Software calculation (voltage measurement 5 current measurement)	Software calculation (voltage measurement 5 current measurement)
Resolution		1 mW	10 mW
Capacity calculation	Range	-2000.000 Ah to 2000.000 Ah	-2000.000 Ah to 2000.000 Ah
	Accuracy *2	Rely on the current measuring accuracy and the time accuracy	
	Resolution	1 mAh	1 mAh
Time *7	Accuracy *2 *8	±10 ppm (TYP values)	±10 ppm (TYP values)

\*1 Measurable range: PFX2512/ -52.500 A to 52.500 A (TYP value) However, accuracy outside of the range is not assured. PFX2532/ -210.000 A to 210.000 A (TYP value) However, accuracy outside of the range is not assured.

\*2 Ambient temperature at 18 °C to 28 °C

\*3 Measurable range: Within the above listed range

\*4 Measurable range: - 6.500 V to 65.000 V (TYP value) However, accuracy outside of the range is not assured.

\*5 Measurable range: - 6.500 V to 6.500 V (TYP value) However, accuracy outside of the range is not assured.

\*6 Common with 6 V/60 V ranges

\*7 Accuracy of the elapsed time (Cutoff condition) when charging / discharging or resting.

\*8 Monthly error: approximately 30 seconds.



# Specifications

# FOR BATTERY TEST SYSTEM PFX2500 SERIES

## Measurement Accuracy

		PFX2512	PFX2532	
High speed sampling				
Current measurement	Range *3	-50.0000 A to 50.0000 A	-200.0000 A to 200.0000 A	
	Accuracy *1 *3 *4	1 ms sampling	± (0.2 % of reading + 0.5 % of rating)	± (0.4 % of reading + 0.5 % of rating)
		10 ms sampling	± (0.15 % of reading + 0.05 % of rating)	± (0.3 % of reading + 0.1 % of rating)
		100 ms sampling	± (0.15 % of reading + 0.02 % of rating)	± (0.2 % of reading + 0.1 % of rating)
	Resolution	1 ms sampling	0.1 mA	1 mA
		10 ms sampling		
100 ms sampling				
Voltage measurement	Range	60 V range	-6.0000 V to 60.0000 V	-6.0000 V to 60.0000 V
		6 V range	-1.0000 V to 6.0000 V	-1.0000 V to 6.0000 V
		Accuracy *1 *3 *4	1 ms sampling *2	± (0.1 % of reading + 0.1 % of rating)
	10 ms sampling *2		± (0.1 % of reading + 0.05 % of rating)	± (0.1 % of reading + 0.05 % of rating)
	100 ms sampling		60 V range: ± (0.05 % of reading + 0.02 % of rating)	60 V range: ± (0.05 % of reading + 0.02 % of rating)
		6 V range: ± (0.05 % of reading + 0.04 % of rating)	6 V range: ± (0.05 % of reading + 0.04 % of rating)	
Resolution *2	1 ms sampling	0.1 mV	0.1 mV	
	10 ms sampling			
	100 ms sampling			

\*1 Ambient temperature at 18 °C to 28 °C

\*2 Common with 6 V/60 V ranges

\*3 Accuracy outside of the rating output range is not assured.

\*4 Fluctuation due to ripple noise of power supply and AC line noise (50 Hz/60 Hz) are not included.

## Temperature measurement

\*The thermistor 103AT-2 (SEMITEC Corporation) is used for temperature detecting element.

		PFX2512	PFX2532
Resistor (temperature) measuring section *1			
Measurement range		-40.0 °C to 100.0 °C	
Measurement resolution		0.1 °C	
Measurement accuracy *2 *3		± 0.5 °C (measurement temperature at 0 °C to 40.0 °C)	
		± 1 °C (measurement temperature at -20 °C to 80 °C)	
Reference (thermistor 103AT-2)			
Part name		Thermistor (103AT-2 by SEMITEC Corporation)	
R25		10.0 kΩ, Nominal zero-power resistor value at 25 °C	
Operating temperature range		-50.0 °C to 110.0 °C	
Temperature accuracy *3		± 0.5 °C (measurement temperature at 0 °C to 40.0 °C)	
Tolerance		± 1 %	
Constant-B		3435 K ± 1 % (measurement temperature at 25 °C)	

\*1 The temperature measurement does not mean tracing absolute temperature. Resistor to temperature conversion value

\*2 Error of temperature detecting element is excluded.

\*3 Ambient temperature at 18 °C to 28 °C

## Protection Functions

		PFX2512	PFX2532
Overvoltage (overcharge) protection		Software OVP, Hardware OVP	
Undervoltage (overdischarge) protection		Software UVP, Hardware UVP	
Overcurrent protection		Software OCP *1, Hardware OCP Load shorting protection	
Capacity (overcharge/overdischarge) protection		Software OAH *2	
Overtemperature (DUT) protection		Software OTP	
Vibration alarm			

\*1 For the software OCP, the application software automatically sets a value obtained by adding 5 A to the preset current.

\*2 The application software calculates the value by multiplying the nominal capacity by the preset percentage and sets the capacity.

## General Specifications

		PFX2512	PFX2532
Nominal input rating			
		100 Vac to 240 Vac, 50 Hz/60 Hz	
Input voltage range		90 Vac to 250 Vac	
Power consumption		60 VAm <sub>ax</sub> OP02-PFX 3 boards installed: 80 VAm <sub>ax</sub>	
Operating temperature/humidity range		0 °C to 40 °C, 20 % rh to 85 % rh (No condensation)	
Storage temperature/humidity range		-10 °C to 60 °C, 0 % rh to 90 % rh (No condensation)	
Operating environment		Indoors, Overvoltage category II	
Altitude		Up to 2000 m	
Isolation voltage	Across the I/O terminals and chassis	± 80 V <sub>max</sub>	± 70 V <sub>max</sub>
	Primary and chassis	500 Vdc, 30 MΩ or greater, 70 % rh or less	
Insulation resistance	Primary and across the I/O terminals		
	Withstand voltage	Primary and chassis	1500 Vac, No abnormalities over 1 minute
Primary and across the I/O terminals			
Safety *1		Complies with the requirements of the following directive and standard. Low Voltage Directive 2014/35/EU EN61010-1 (Class I *2, Pollution degree 2)	Complies with the requirements of the following directive and standards. Low Voltage Directive 2014/35/EU EN 61010-1 (Class I *2, Pollution degree 2)
		Complies with the requirements of the following directive and standard. EMC Directive 2014/30/EU EN61326-1 (Class A *3) EN55011 (Class A *3, Group 1 *4) EN61000-3-2 EN61000-3-3 Applicable under the following conditions The maximum length of all cabling and wiring connected to the PFX2512 is less than 5 m.	Complies with the requirements of the following directive and standards. EMC Directive 2014/30/EU EN 61326-1 (Class A *3) EN 55011 (Class A *3, Group 1 *4) EN 61000-3-2 EN 61000-3-3 Applicable under the following conditions The maximum length of all cabling and wiring connected to the PFX2532 is less than 3 m.
Electromagnetic compatibility(EMC) *1			
External dimensions		Refer to the dimensions	
Weight		Approx. 7 kg (15.43 lb)	Approx. 17 kg (37.48 lb)
Accessories	Power cord	1 pc	1 pc
	Cable with crimp terminal	4 pcs (Red: 2 pcs, White: 2 pcs) 45 cm each (17.72 inch)	-
	I/O terminal cover set	-	Three terminal covers, six cable ties for locking
	I/O terminal M8 screw set	-	6 sets
	Load input terminal cover set	-	Cover, four auxiliary bands
	26-core flat cable	1 pc	1 pc
	20-core flat cable	1 pc	1 pc
	26-core cable (for PAT-T)	-	1 pc
	Sensing connector	1 pc	1 pc
	Sensing connector cover set	-	One cover set, one cable tie for locking
Thermistor	1 pc	1 pc	
Lock lever	2 pcs	2 pcs	
LAN cable (2 m)	1 pc	1 pc	
Operation manual	1 copy	1 copy	

\*1 Limited to the product with CE marking on panel. Not applied to specially ordered or modified articles.

\*2 This product is the Class I equipment. Please be sure to connect the protection conductor terminal of product to ground. If not correctly connected to ground, safety is not guaranteed.

\*3 This product is the Class A equipment. It is aimed to use the product under the industrial environment. If this product is used in housing area, it might be the cause of interference. If it is the case, special action to reduce electromagnetic radiation might be required for users in order to prevent receiving interference.

\*4 This product is the Group 1 equipment. The product does not generate/use radio frequency energy in the form of electromagnetic radiation, induction and/or static coupling intentionally for material processing or inspection/analysis.

# For evaluation of secondary batteries! Solution for battery test achieved with our DC power supply and electronic load!!

Charge/Discharge test system can be configured for up to 60V and 50A

**PFX2511 is a high performance Charge/Discharge system controller that takes measurements in combination with our DC power supply and electronic load.**

In recent years, voltage (number of stacks) and capacity (Ah value) of secondary batteries have become varied, and support for such diversity is required of characteristic evaluations and test equipment. However, the general-purpose test equipment supports measurements and evaluations of large-capacity batteries. We were left with no choice but prepare a DC power supply, electronic load, digital multi-meter, recorder, temperature measuring device and such equipment and order a custom-designed system to control them or make it on our own (while worrying about the reliability). Based on our abundant experience with battery evaluation systems, we have packed PFX2511 with our technology of Charge/Discharge control and high-precision measurement required for electronic characteristic evaluation of batteries. If you already have our power supply and electronic load, you can easily configure a high-precision battery test system.

## System configuration (example) ▼

The example system configuration consists of the charge/discharge system controller "PFX2511", the DC power supply "PWR800L", and the Electronic load "PLZ1004W". The dimension of the system may differ depends on the configuration of the selected models. (the PC show in the picture is not included.)The PFX2121 (communication control unit) is also required.



## Charge/Discharge System Controller

# PFX2511

Examples of Applications

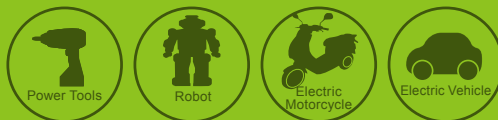

Application examples for secondary batteries



Item	PFX2511
Rating	60 V / 50 A
Application software	BPChecker2000 (free version attached, 2-CH without limitation of function from qualified version)
Communication interface	TP-BUS (PFX2121 is required for PC connection)
Monitoring data minimum time interval	1 s (up to 30 channels), 2 s (more than 30 channels)
High speed data sampling	×
Charge/discharge mode	6 modes Charging: CC, CC-CV Discharging: CC, CP, CC-Pulse, CP-Pulse
Test condition configuration	Maximum 20 patterns are divided into individual loop setting and total repeat setting with charging and discharging as a pair.
Seamless charge/discharge	× (Approx. 2 seconds for charge/discharge transfer time: Depending on the number of channels)
Termination condition	Fixed time

## Flexible configuration of the system achieved with the conventional power supply and electronic load

# FOR BATTERY TEST SYSTEM PFX2500 SERIES

PFX2511 is used as a charge and discharge test system combined with the selected DC power supply (charging) and electronic load (discharging). This allows flexible configuration of the system.

### ● System Conceptual Diagram

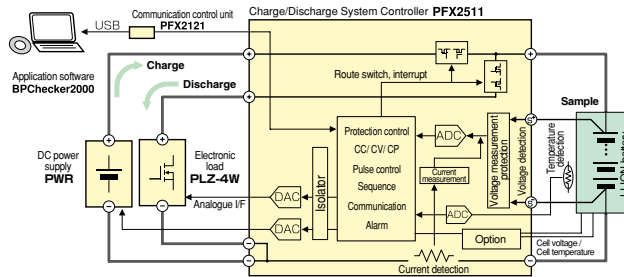

## Easy configuration

The selected equipment can be assigned for the system!

It is possible to configure the system by yourself. All the parts required for connection can be purchased from us. The DC power supply and electronic load that are applied configuration with PFX2511, can be used for the system. This allows you to have a test system at low cost.

\* For details, please refer to the list of applied configuration and options on page 18.

## Control of the Constant Current (CC) and Constant Voltage (CV)

The digital CC and CV control method is adopted to minimize the difference between the setting accuracy and the drift characteristic of constant current (CC) / constant voltage (CV) genera and the electronic load, and it can apply for the precise evaluation. Any of the adjustment are not required after the system configuration.

## Protection Functions for Safety Operation

Several protective functions are required to improve the safety of charge and discharge test of secondary batteries. PFX2511 is equipped with protection functions provided by hardware and software against phenomena such as overcharge and overdischarge. The route switch (load switch) is built in the PFX2511 and it equips with a function to ensure connection between the DUT (batteries) and the DC power supply/electronic load as well as a high-speed interruption function that promptly disconnects the DC power supply / electronic load in case any abnormal state is detected. In addition, the vibration sensor detects major vibration and shock in case of a disaster or accident during charge and discharge test, then shuts off the output, and it prevents a damage to the connected equipment and the DUT (batteries).

## System Configuration

### [2511 System Configuration example]

(model ID : 5101)

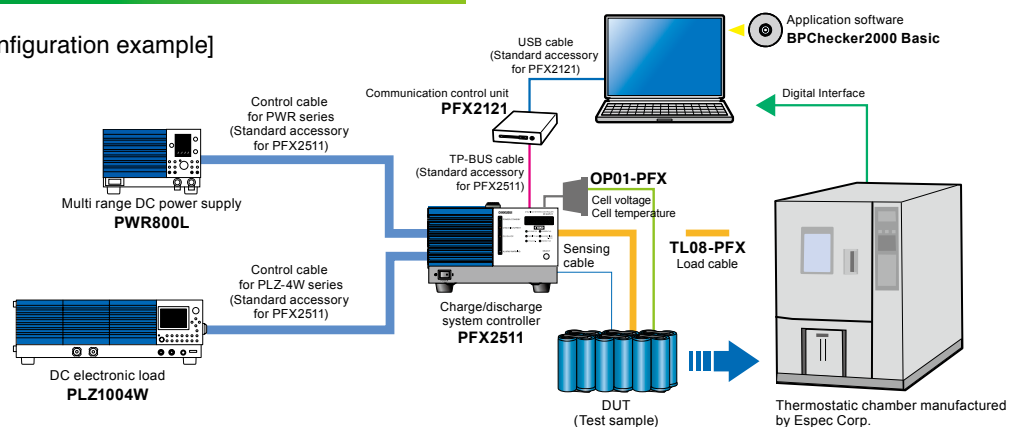

- Multi range DC power supply ..... PWR800L
- DC electronic load ..... PLZ1004W
- Charge/discharge system controller ..... PFX2511
- Communication control unit..... PFX2121
- Application software ..... BPChecker2000Basic.(Standard accessory)
- Voltage/thermometer unit..... OP01-PFX
- Sensing Cable..... TL09-PFX

- Load cable(50 A, 5 m).....TL08-PFX
- Personal computer.....Windows XP or later. Display resolution: 1024 x 768 or more
- Thermostatic chamber.....Supports synchronized operation with temperature chambers. To perform synchronized operation, temperature chambers equipped with a communication function, manufactured by ESPEC and the associated components are required. For details, please consult with us.

## Precise Measurement

The high-precision measurement circuit is equipped in the PFX2511. It detects the battery voltage and the charge and discharge current in high accuracy. (Measurement resolutions: 100  $\mu$ V and 100  $\mu$ A, Elapsed time measurement: within 10 ppm)

## Pulse discharge function

It allows discharge test that simulates a change of dynamic load current in cellular phones, digital cameras, laptop computers, etc. Capacity calculation is performed with the actual measurements from the pulse current, and the maximum and minimum voltages in the cycle are also measured.

## Capable of complex control of charge and discharge

The unit can perform complex control of charge and discharge required for testing (controls time and measurement of voltage, current, temperature, capacity and power). Even when controlling remotely, a change of the display with the switches on the front panel allows you to view and check the details of the test.

## Protection function for the DUT cable connection

It detects such as an incomplete connection of the DUT, an abnormality of wirings, the potential difference when it exceeds a regulated value of the DUT cable and the voltage sensing line, and it protects connecting equipment and the DUT (battery) from being damaged.



# PFX2511 Exclusive Application Software, BPChecker2000 Basic

Comprehensive management from test condition setting to execution and data analysis on test results by PFX2511 exclusive application software, BPChecker2000 Basic

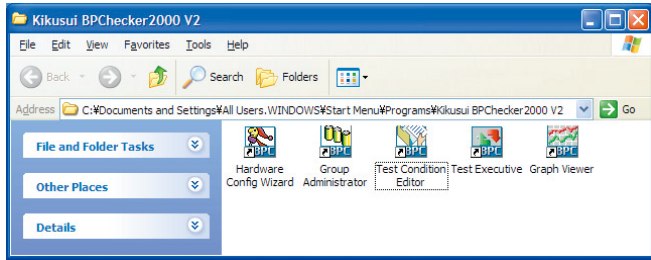

The application software, BPChecker2000, can manage all processes from creating the test condition file to output of the test result file. Setting and execution of conditions for battery charge and discharge characteristics test and an analysis of test results can be performed on the PC. In addition, if the PC is equipped with GPIB communication environment, it can externally control the temperature chambers manufactured by ESPEC, and it allows to synchronize with the temperatures in the chamber.

\* The control of BPChecker2000 Basic supplied with PFX2511 is limited to 2 channels. BPChecker2000 Full Edition with no function limit is sold separately.

## Program Structure

### Test Condition Editor

This program is used to create and edit all test conditions related to charge/discharge testing. A total of 20 sheets of test condition data can be created, with each sheet specifying both charge and discharge conditions. It is also possible to set the number of times (repeats) that an individual sheet is to be repeated to form a particular charge/discharge cycle, as well as the repeated number of (loops) the entire sheets can be set.

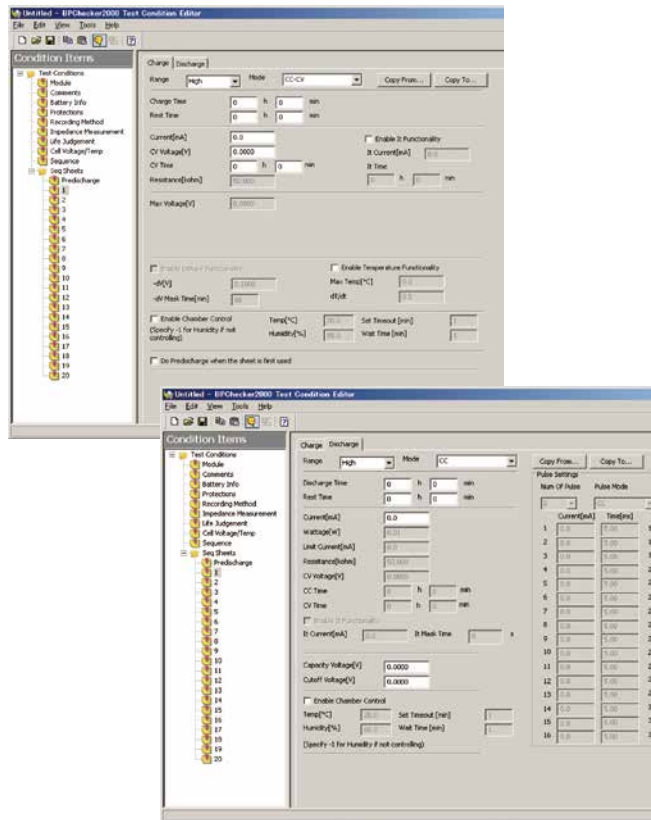

### Test Executive

This program executes charge/discharge tests according to the test condition file created using the Test Condition Editor. It starts and stops the test and monitors the test execution. The program provides a real-time graphic representation of the per-channel charge/discharge trends.

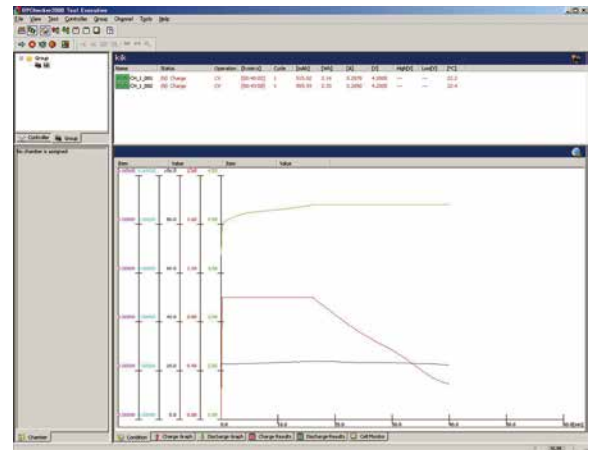

### Graph Viewer

This program is used to display the graph of test data on the screen and print the graph. It offers a graphic representation of the charge/discharge data of each cycle. You can display up to 99 sets of data to superimpose the graph of each other and perform statistical processing.

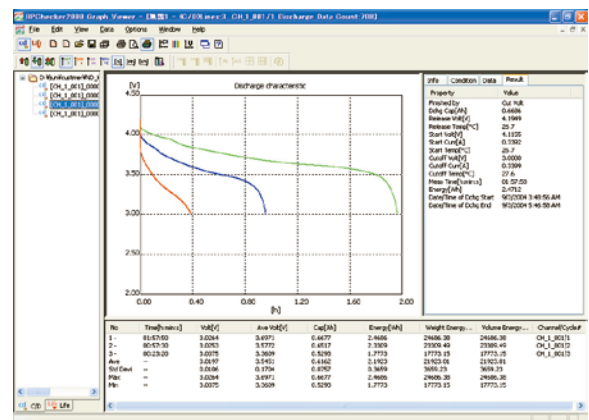

#### [Recommended operating environment]

- CPU: Pentium IV 1 GHz or faster
- OS: Windows XP (SP2 or later, x86) , Vista (x86, x64) , 7(x86, x64)
- Memory: 512 MB or more
- HD drive: 50 MB of free space or more required for installation: 10 GB of free space or more recommended for data
- CD-ROM drive: Required for installing the applications
- Mouse: Required
- Display resolution: 1024 x 768 or more
- Printer: Compatible with windows
- No. of USB ports: More free USB ports than the number of control units to be used
- The thermostatic chambers that can be controlled via Espec Corp.'s protocol converter/USB-RS485 converter.
- VISA library: NI-VISA 3.3 or later, Agilent I/O Libraries Suite 15.0 or later , or KI-VISA 3.1.3 or later

# FOR BATTERY TEST SYSTEM PFX2500 SERIES

Test sample data taken by the application software BPChecker2000

## Discharge Rate Characteristics Test

Test to observe characteristics with varying load conditions under constant charge condition and discharge temperature.

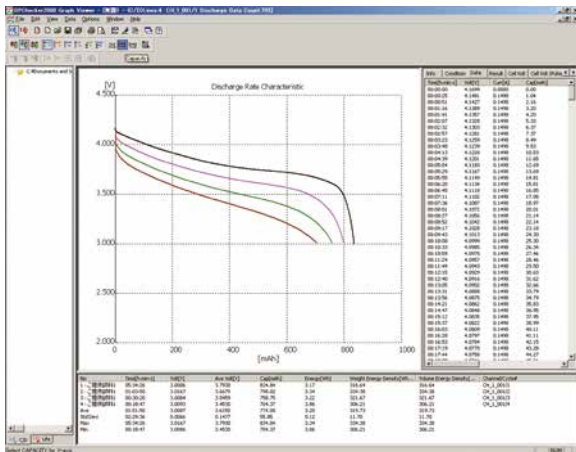

## Discharge Temperature Characteristics Test

Test to observe characteristics with varying discharge temperatures under constant charge condition and discharge current.

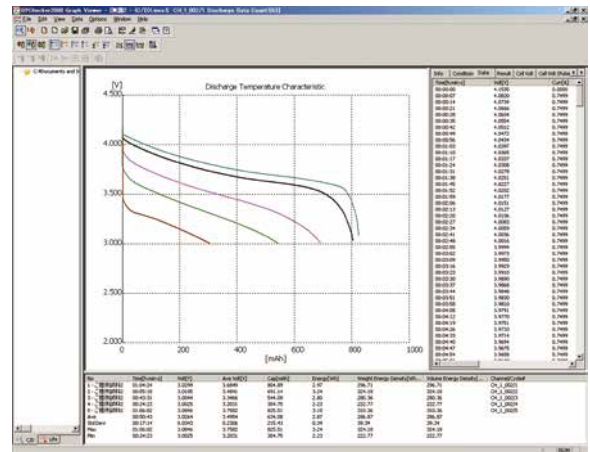

## Cycle Life Test

Test to observe capacity deterioration in repeated cycles under constant charge and discharge conditions.

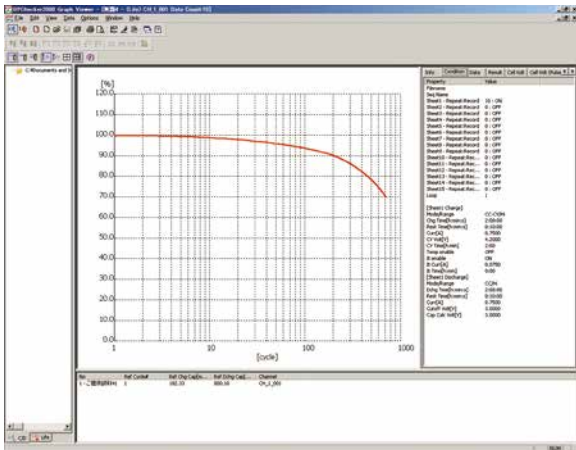

## Pulse Discharge Test

Discharge characteristics similar to the actual load environment can be obtained using the pulse discharge mode.

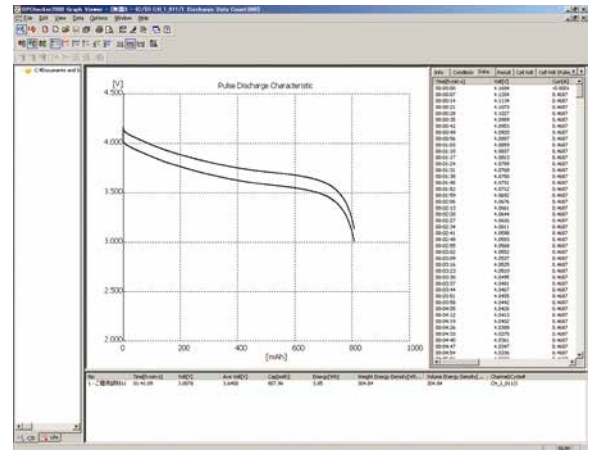

## Report Output

Plotted images can be printed out by Graph Viewer.

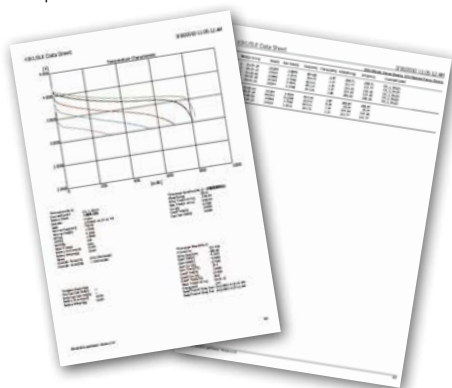

## Copy & Paste to Excel and PowerPoint

The plotted graphs and numerical data can be pasted to other application software such as Excel and PowerPoint.

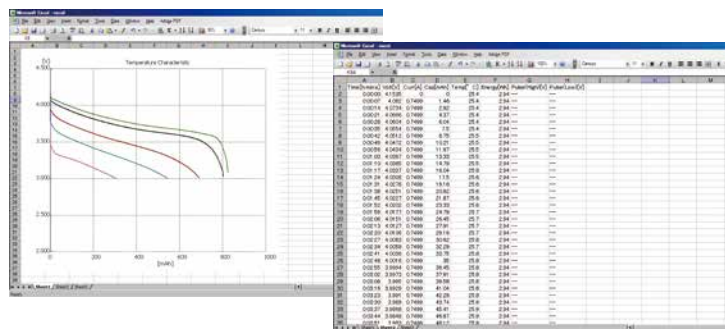

Example of Excel display

# Specifications

## Rated Output

		PFX2511
Number of output		1 ch
Charging current range *1		0.000 A to 50.000 A
Charging voltage range *1	60 V range	0.000 V to 60.000 V
	6 V range	-
Discharge current range *1		0.000 A to 50.000 A
Discharge voltage range *1 *2	60 V range	0.000 V to 60.000 V
	6 V range	-

\*1 Range might be different depending on power supply to be connected, model of electronic load, wiring situation, etc.

\*2 Lowest dischargeable voltage might be different depending on electronic load model to be connected, wiring situation, etc.

## Setting Accuracy

		PFX2511	
Static			
Constant current charge/discharge	Range *1	0.000 A to 50.000 A	
	Accuracy *2	*3	
	Resolution	1 mA	
Constant voltage charging	Range *1	60 V range	0.000 V to 60.000 V
		6 V range	-
	Accuracy *2	*3	
Constant cell voltage Charge/discharge *7	Range *1	-	
	Accuracy *2	-	
	Resolution	-	
Constant power discharging	Range *1	0.1 W to 3 000.0 W	
	Accuracy *2 *4	*3	
	Resolution *5	100 mW	
Pulse			
Constant current discharging	Range *1	0.000 A to 50.000 A	
	Accuracy *2	*3	
	Resolution	1 mA	
	Number of settings	20 values	
	Time width	Range	5.0 ms to 65 000.0 ms
		Accuracy *2 *6	±(0.05 % of set + 0.05 ms)
Constant power discharging	Range *1	60 V range	0.1 W to 3 000.0 W
		6 V range	-
	Accuracy *2 *4	*3	
	Resolution	60 V range	100 mW
		6 V range	-
	Number of settings	20 values	
Time width	Range	5.0 ms to 65 000.0 ms	
	Accuracy *2 *6	±(0.05 % of set + 0.05 ms)	
Resolution	100 μs		
Pattern			
Pattern constant current	Range	-	
	Accuracy	-	
	Resolution	-	
	Number of settings	-	
	Time width	Range	-
Accuracy		-	
Resolution		-	
Pattern constant power	Range	-	
	Accuracy	-	
	Resolution	-	
	Number of settings	-	
	Time width	Range	-
Accuracy		-	
Resolution		-	

\*1 Range might be different depending on DC power supply to be connected, model of electronic load, wiring situation, etc.

\*2 Ambient temperature at 18 °C to 28 °C

\*3 External equipment is controlled so as to Measurement Value being equal to Set Value by the software control.

\*4 60 V range = At battery voltage above 5 V, 6 V range = at above 0.5 V

\*5 Voltage activation range for constant power discharge: 5 V to 60 V (assured value)

\*6 Measure time after setting trigger at the half position (1/2) of pulse width (current amplitude)

\*7 Can be set only when the optional Volt / Thermometer Unit OP02-PFX or OP03-PFX Voltmeter Unit is installed.

Unless specified otherwise, the specifications are for the following settings and conditions.

\* The warm-up time is 30 minutes. \* TYP (typical) values do not guarantee the performance.

\* "reading" Indicates the readout value. \* "set" Indicates the setting value. \* "rating" Indicates the rated. \* "Static" General term to indicate CC charge, CC-CV charge, CC discharge, CC-CV discharge, CP discharge, and CP-CV discharge \* "Pattern" General term to indicate pattern charge/discharge and I-V characteristics charge/discharge

## Measurement Accuracy

		PFX2511	
Static			
Charge / discharge current measurement	Range	0.0000 A to 50.0000 A	
	Accuracy *1 *2	± (0.15 % of reading + 0.02 % of rating)	
	Resolution	0.1 mA	
Voltage measurement	Range	60 V range	-6.0000 V to 60.0000 V
		6 V range	-
	Accuracy *1 *2 *3	60 V range	± (0.05 % of reading + 0.02 % of rating)
		6 V range	-
Resolution *3	0.1 mV		
Power measurement	Range	-	
	Accuracy	-	
	Resolution	-	
Capacity calculation	Range	0.000 Ah to 2000.000 Ah	
	Accuracy *1 *2	Depends on the current measurement accuracy and the time accuracy	
	Resolution	1 mAh	
Time *4	Accuracy *1 *5	±10 ppm (TYP values)	
Pulse			
Charge / discharge current	Range	0.0000 A to 50.0000 A	
	Accuracy *1 *2	±(0.2 % of reading + 0.03 % of rating)	
	Resolution	0.1 mA	
	Measured value	Average current; updated every 500 ms (consecutive measurements)	
Battery voltage	Range	0.0000 V to 60.0000 V	
	Accuracy *1 *2	±(0.05 % of reading + 0.02 % of rating)	
	Measurement	Resolution	0.1 mV
		High voltage	Indicates the maximum battery voltage in one cycle of the pulse setting.
Low voltage		Indicates the minimum battery voltage in one cycle of the pulse setting.	
Arbitrary	At the specified pulse point		
Capacity calculation	Range	0.000 Ah to 2 000.000 Ah	
	Accuracy *1 *2	Rely on the current measuring accuracy and the time accuracy	
	Resolution	1 mAh	
Time *4	Accuracy *1 *5	±10 ppm (TYP values)	
Pattern			
Charge / discharge current	Range	-	
	Accuracy	-	
	Resolution	-	
	Measured value	-	
Voltage measurement	Range	60 V range	-
		6 V range	-
	Accuracy	60 V range	-
		6 V range	-
Resolution	-		
Power measurement	Range	-	
	Accuracy	-	
	Resolution	-	
Capacity calculation	Range	-	
	Accuracy	-	
	Resolution	-	
Time	Accuracy	-	

\*1 Ambient temperature at 18 °C to 28 °C.

\*2 Measurable range: within the range listed in the table.

\*3 Common with 6 V/60 V ranges.

\*4 Accuracy of the elapsed time (cutoff condition) when charging/discharging or resting.

\*5 Monthly error: approximately 30 seconds.



# Specifications

# FOR BATTERY TEST SYSTEM PFX2500 SERIES

## Measurement Accuracy

		PFX2511		
High speed sampling				
Current measurement	Range		-	
		Accuracy	1 ms sampling	-
			10 ms sampling	-
	100 ms sampling		-	
	Resolution	1 ms sampling	-	
		10 ms sampling	-	
100 ms sampling		-		
Voltage measurement	Range	60 V range	-	
		6 V range	-	
	Accuracy	1 ms sampling	-	
		10 ms sampling	-	
		100 ms sampling	-	
	Resolution	1 ms sampling	-	
		10 ms sampling	-	
		100 ms sampling	-	
				-

## Temperature measurement

\*The thermistor 103AT-2 (SEMITEC Corporation) is used for temperature detecting element.

		PFX2511	
Resistor (temperature) measuring section *1			
Measurement range		-40.0 °C to 100.0 °C	
Measurement resolution		0.1 °C	
Measurement accuracy *2 *3		± 0.5 °C (measurement temperature at 0 °C to 40.0 °C)	
		± 1 °C (measurement temperature at -20 °C to 80 °C)	
Reference (thermistor 103AT-2)			
Part name		Thermistor (103AT-2 by SEMITEC Corporation)	
R25		10.0 kΩ, Nominal zero-power resistor value at 25 °C	
Operating temperature range		-50.0 °C to 110.0 °C	
Temperature accuracy *3		± 0.5 °C (measurement temperature at 0 °C to 40.0 °C)	
Tolerance		± 1 %	
Constant-B		3435 K ± 1 % (measurement temperature at 25 °C)	

\*1 The temperature measurement does not mean tracing absolute temperature. Resistor to temperature conversion value

\*2 Error of temperature detecting element is excluded.

\*3 Ambient temperature at 18 °C to 28 °C

## Protection Functions

		PFX2511	
Overvoltage (overcharge) protection		Software OVP, Hardware OVP	
Undervoltage (overdischarge) protection		Software UVP, Hardware UVP	
Overcurrent protection		Software OCP *1, Hardware OCP Load shorting protection	
Capacity (overcharge/overdischarge) protection		Software OAH *2	
Overtemperature (DUT) protection		Software OTP	
Vibration alarm			

\*1 For the software OCP, the application software automatically sets a value obtained by adding 5 A to the preset current.

\*2 The application software calculates the value by multiplying the nominal capacity by the preset percentage and sets the capacity.

## General Specifications

		PFX2511	
Nominal input rating		100 Vac to 240 Vac, 50 Hz/60 Hz	
Input voltage range		90 Vac to 250 Vac	
Power consumption		60 VAmx OP01-PFX 3 boards installed: 80 VAmx	
Operating temperature/humidity range		0 °C to 40 °C, 20 % rh to 85 % rh (No condensation)	
Storage temperature/humidity range		-10 °C to 60 °C, 0 % rh to 90 % rh (No condensation)	
Operating environment		Indoors, Overvoltage category II	
Altitude		Up to 2000 m	
Isolation voltage	Across the I/O terminals and chassis	± 80 Vmax	
Insulation resistance	Primary and chassis	500 Vdc, 30 MΩ or greater, 70 % rh or less	
	Primary and across the I/O terminals		
Withstand voltage	Primary and chassis	1500 Vac, No abnormalities over 1 minute	
	Primary and across the I/O terminals		
Safety *1		Complies with the requirements of the following directive and standard. Low Voltage Directive 2006/95/EC EN61010-1 (Class I *2, Pollution degree 2)	
Electromagnetic compatibility(EMC) *1		Complies with the requirements of the following directive and standard. EMC Directive 2004/108/EC EN61326-1 (Class A *3) EN55011 (Class A *3, Group 1 *4) EN61000-3-2 EN61000-3-3 [Application conditions] All cables and wires used to connect the product should be less than 5 meter length.	
External dimensions		Refer to the dimensions	
Weight		Approx. 7 kg (15.43 lb)	
Accessories	Power cord	1 pc	
	Cable with crimp terminal	4 pcs (Red: 2 pcs, White: 2 pcs) 45 cm each (17.72 inch)	
	26-core flat cable	1 pc	
	20-core flat cable	1 pc	
	Twisted pair cable with TP-BUS connector	1 pc (1 m (39.37 inch))	
	Sensing connector	1 pc	
	Thermistor	1 pc	
	Lock lever	2 pcs	
	Operation manual	1 copy	
	BPChecker2000 Setup guide	1 copy	
BPChecker2000 Basic Edition CD-ROM	1 pc		

\*1 Limited to the product with CE marking on panel. Not applied to specially ordered or modified articles.

\*2 This product is the Class I equipment. Please be sure to connect the protection conductor terminal of product to ground. If not correctly connected to ground, safeness is not guaranteed.

\*3 This product is the Class A equipment. It is aimed to use the product under the industrial environment. If this product is used in housing area, it might be the cause of interference. If it is the case, special action to reduce electromagnetic radiation might be required for users in order to prevent receiving interference.

\*4 This product is the Group 1 equipment. The product does not generate/use radio frequency energy in the form of electromagnetic radiation, induction and/or static coupling intentionally for material processing or inspection/analysis.

# PFX2500 Series Optional

## Voltage/thermometer unit [OP01-PFX] PFX 2511 [OP02-PFX] PFX 2512 PFX 2532

When monitoring the status of each cell of the battery pack is required, install the optional voltage/thermometer unit OP01-PFX/OP02-PFX. By installing OP01-PFX on PFX2511 and by installing OP02-PFX on PFX2512/2532, voltages/temperatures for four cells are able to be monitored/logged with one sheet, respectively. (Up to 3 boards can be installed.)



Voltage/thermometer unit  
[OP01-PFX]  
[OP02-PFX]

For a battery pack connected in series, monitoring of balance among cells is important. With OP01-PFX, the charge and discharge control can be stopped according to the status of each cell. In addition, it is equipped with a function to stop charge and discharge when the balance between the cells in the battery pack becomes large (maximum voltage - minimum voltage). Furthermore, at the time of pulse discharge, voltage can be measured at the same time as the synchronization of all cells for load fluctuations.

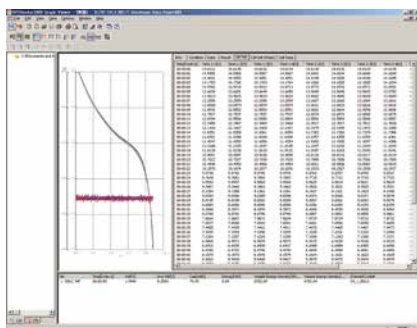

### Expanded features

Monitor data: Cell voltage, cell temperature, cell high voltage\*1 and cell low voltage\*1

Charge stop conditions: Cell voltage, cell temperature and potential difference among cells

Discharge stop conditions: Cell voltage and potential difference among cells, cell temperature

Charge/discharge conditions\*2: Cell voltage, cell temperature, Cell unbalance

Protective functions: Cell voltage, cell temperature and potential difference among cells

\*1 Pulse discharge only. OP01-PFX only \*2 OP02-PFX only

### Restricted functions

The maximum number of channels that 1 unit of personal computer can control is 5 ch.

### Voltage/thermometer unit OP01-PFX/OP02-PFX Specifications

	OP01-PFX	OP02-PFX
Cell measurement function		
Static/Pattern (OP02-PFX only)		
Cell voltage	Average voltage of the every 500 ms	Average voltage of the every 100 ms
Cell temperature	Temperature measurement function to make thermocouple as temperature detecting element, updated every second	
Pulse		
Cell voltage	Maximum voltage and minimum voltage in a cycle Arbitrarily set voltage measuring point	-
Cell temperature	Temperature Measurement Function to make thermocouple as temperature detecting element, updated every second	-
Cell voltage measurement		
Static/Pattern (OP02-PFX only)		
Number of measurement terminals	4	
Measurable range *1	-2.0000 V to 20.0000 V	
Accuracy *2	± (0.05 % of rdng + 0.02 % of f.s)	
Measurement resolution	0.1 mV	
Measurement value	Average voltage of the every 500 ms	Average voltage of the every 100 ms
Measurement Interval	500 ms	100 ms
Pulse		
Number of measurement terminals	4	-
Measurable range *1	-2.0000 V to 20.0000 V	-
Accuracy *2	± (0.05 % of rdng + 0.02 % of f.s)	-
Measurement resolution	0.1 mV	-
Measurement	High voltage	Maximum voltage in one cycle
valu *3	Low voltage	Maximum voltage in one cycle
Measurement Interval *4	1 ms	-
Cell temperature measurement *5		
Number of measurement terminals	4	
Thermocouple type	K type	
Measurable range *6	-100.0 °C to 400.0 °C	
Accuracy *2 *7	± 1.5 °C (TYP values)	
Reference junction accuracy *2 *8	± 0.5 °C (TYP values)	
Resolution	0.1 °C	
Measurement interval	1 s	

\*1 You can apply a voltage from -20 V to 22 V.

\*2 Ambient temperature at 18 °C to 28 °C.

\*3 Automatically synchronized with the BPChecker2000 pulse setting (specify two points from high voltage, low voltage, and user-specified).

\*4 The application software records data every second. [Data recording time] BPChecker2000 : 1 s to...

\*5 The temperature scale conforms to JIS C 1602-1995 (ITS-90). (ITS-90 is an international temperature scale.)

\*6 Depending on your thermocouple's specifications (thermocouple class, wire diameter and insulation), the usable temperature range will vary.

\*7 When the voltage that the thermocouple calibrator produces is measured.

\*8 This shows the internal sensor performance. This indicates the temperature measurement accuracy of the thermocouple connector.

Thermometer accuracy = Measurement accuracy + reference junction compensation + thermocouple tolerance

## 8Slot Unit [SL01-PFX] PFX 2512 PFX 2532

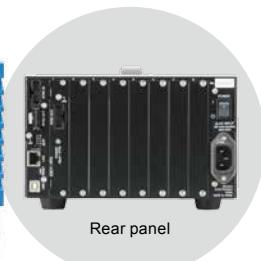

Rear panel

The 8Slot Unit SL01-PFX is connected to the PFX2512/2532 Charge/Discharge System Controller to expand the voltage measurement points. For this connection, an EX01-PFX connection board is installed into the PFX2512/2532. It enables highly accurate evaluation of cell voltage disparity measurements, which is indispensable for evaluation testing of large capacity battery modules. If Voltmeter Units OP03-PFX are installed in all SL01-PFX slots, voltage measurement points can be expanded to 64 points. Further, by installing Volt/Thermometer Units OP02-PFX in the PFX2512/2532, you can increase the number of measurement points to 72.

### 8Slot Unit SL01-PFX Specifications

	SL01-PFX
Number of slots	8
Compatible boards *1	Voltmeter Unit OP03-PFX
Interface	LAN(Ethernet) PC connection
	Sync connector EX01-PFX connection
Input voltage range	90 Vac to 250 Vac, 50 Hz/60 Hz
Power consumption	when 8 OP03-PFXs are installed: 80 VAm <sub>ax</sub>
Operating temperature and humidity range	0°C to 40°C, 20 %rh to 85 %rh (no condensation)
Dimensions	214.5 W × 155 H × 440 Dmm
weight	Approx. 5 kg (11.02 lb)
	Power cord/100 V System (1 pc.)
	Power cord/200 V System (1 pc.)
Accessories	EX01-PFX (1 pc.) extension board (for installing in a PFX2512/2532 slot)
	LAN cable (1 pc.) 2m Straight type
	14-core flat cable (1 pc.)
	Ferrite core for 14-core flat cable (1 pc.)
	Lock lever (2 pcs.)
	Handling of the product (1 copy)

\*1 OP02-PFX cannot be installed.

# FOR BATTERY TEST SYSTEM PFX2500 SERIES

## Voltmeter Unit [OP03-PFX]

PFX 2512 PFX 2532

By installing an Voltmeter Unit OP03-PFX in an option slot on the SL01-PFX, you can increase the number of voltmeter measurement points. If OP03-PFX units are installed in all option slots of the SL01-PFX, voltage measurement points can be expanded to 64 points.



### ■ Voltmeter Unit OP03-PFX Specifications

	OP03-PFX
Cell voltage measurement	
Number of measured terminals	8
Measurement range *1	-2.0000 V to 20.0000 V
Measurement accuracy *2	±(0.05 % of reading + 0.02 % of rating)
Resolution	0.1 mV
Measured value	Average voltage every 100 ms
Measurement interval	100 ms

\*1 You can apply a voltage from -20 V to 22 V.

\*2 Ambient temperature at 18°C to 28°C.

## Load Cable Set [TL08-PFX]

PFX 2511 PFX 2512

Load cable(with voltage current, and temperatur sensing cable.)

- Rating: 50 A ■ Length: Approx. 5 m
- Thermistor installed
- Maximum operating temperature: 105 °C

## Sensing Cable Set [TL09-PFX]

PFX 2511 PFX 2512 PFX 2532

Lead wire for voltage/thermometer unit

- K type thermocouple for 4 cells
- Length: Approx. 5 m

## Cable Set [TL10-PFX]

PFX 2532

This is a cable set for connecting the PFX2532 to configure a charge/discharge system.

- Rated current: 200 A ■ DUT cable: Approx. 3 m
- DC power supply connection cable: Approx. 60 cm
- Electronic load connection cable: Approx. 60 cm
- Voltage sensing cable with the thermistor
- CE compliant product
- Maximum operating temperature: 75 °C (Connection cable/ DUT cable)

## Cell Voltage Sensing Cable Set [TL11-PFX]

PFX 2512 PFX 2532

Sensing cable set (for OP03-PFX)

- This product supports eight voltage measurement points.
- Length: Approx. 5 m
- Maximum operating temperature: 105 °C
- No-finished end on the side of test materials

## Cell Voltage Sensing Cable Set [TL12-PFX]

PFX 2512 PFX 2532

Sensing cable set (for OP03-PFX)

- This product supports eight voltage measurement points.
- Length: Approx. 3 m ■ Maximum operating temperature: 105 °C
- No-finished end on the side of test materials
- CE compliant product

## Rack mount system

PFX 2511 PFX 2512 PFX 2532

We also provide a rack mounting service.

- System rack: KRC363L

\* The picture shown below is an example of the rack mount system



## Coordination between BPChecker3000 and Vehicle Spy3

PFX2512/2532 system is able to be connected to battery pack where BMS (Battery Management System) is equipped. Charge/discharge test is able to be conducted while communicating with BMS by combining exclusive application software [BPChecker3000], and vehicle-installed network analysis tool [Vehicle Spy3].

### ■ Function example

(May not be realized depending on BMS specifications\*)

- Record data BMS data during charge/discharge test (save text file)
- BPChecker3000 receives alarm generated by BMS and stops charge/discharge test
- Parameters assigned to BMS at charge/discharge starting time are automatically sent out
- Readout/writing BMS setting parameters

\*Our company will perform Vehicle Spy3 customization upon accepting the presentation of BMS specifications by customers. Please consult us separately since BMS specifications are different by every customer. In addition, please contact the following for inquiry related to Application Software, [Vehicle Spy3].

**Embedded Car Unit (ECU) Developing Tool; Japan Intrepid Control Systems, Inc.**

Yokohama World Porters 6F, 2-2-1, SHINKO, Naka-Ku, Yokohama-City, 231-0001

Phone: 045-222-2014 www.intrepidcs.com

### ■ System Outline Drawing

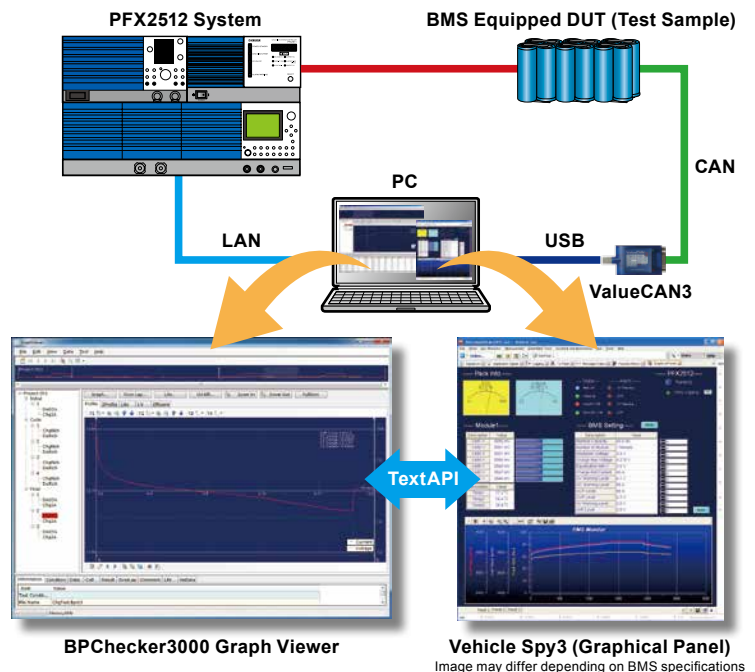



# The System with PFX2500 Series

## ● Applied configuration (model ID)

Model ID is used for combination of the selected power supply and electronic load if you wish to have a combination that is not on the available model ID list, please consult with us. More model IDs will be added in future. The latest information for the system configuration is available on our website.

Model ID		Power supply for charge	Electronic load for discharge
PFX2511	PFX2512		
5101	7101	PWR800L	PLZ1004W
5102	7102	PWR800L	PLZ1004W *1
5103	7103	PWR1600L	PLZ1004W × 2
5104	7104	PWR800L	PLZ334W
5105*4	7105*4	PAT60-67T	PLZ1004W + 2004WB
5106	7106	PWR1600L	PLZ1004W
5107	7107	PAS10-70	PLZ1004W
5108	7108	PAS20-36	PLZ1004W
5109	7109	PAS20-54	PLZ1004W
5110	7110	PAS40-27	PLZ1004W
5111	7111	PWR800L	PLZ164W
5112	7112	PAS10-35	PLZ334W

Model ID		Power supply for charge	Electronic load for discharge
PFX2532			
7301		PWR1600L (two units in parallel)	LZ1004W *2 + PLZ2004WB
7302		PAT60-133T	PLZ1004W *2 + PLZ2004WB(2 units in parallel)*3
7303		PAT40-200T	PLZ1004W *2 + PLZ2004WB(2 units in parallel)*3

\*1 M range [As of the end of February, 2016]

\*2 H range

\*3 Can be replaced with the Kikusui SR Large Capacity Electronic Load Smart Rack System PLZ5004W.

\*4 Additional adjustment fee is required.

## ● Note on selecting power supply for charge (route loss)

Application of the charge current causes a voltage drop in the DUT cable, connecting cables, the current pass route of the PFX2500 series, etc. The power loss at charging caused by this voltage drop is the route loss. The maximum power that can be used for charging is the value from which the route loss is subtracted. [Maximum charge power = Maximum rated power of DC power supply - Route loss]

## ● Note on selecting electronic load for discharge (minimum operating voltage for discharge)

The electronic load has minimum operating voltage (1.5 V in PLZ1004W), and it does not operate at the voltage below the specified level. The result of an addition of this level and the route loss (voltage drop) is the minimum operating voltage for discharge.



[Minimum operating voltage for discharge = Minimum operating voltage of electronic load + Voltage drop caused by route loss]

The list of compatible models for combination shown below uses the test lead instead of the rated outputs, and shows the estimated outputs at the battery terminal when used with the maximum current.

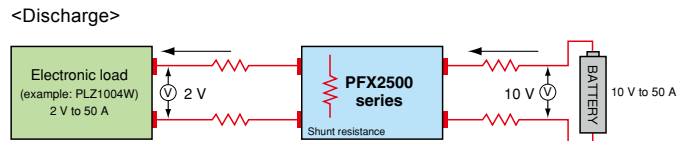
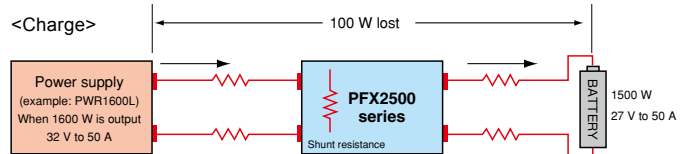
[Conceptual diagram of route loss]



## ● List of the applied configuration with PFX2500 series \* If you wish to have a combination other than the models below, please contact with us.

Power supply for charging	Estimated output			Input	Remark	Appearance
	Voltage (V)	Current (A)	Power limit (W)			
PWR400L	0 to 60	0 to 25	350	AC 100/200 V 6.5/3.3 A	Wide range DC power supply Constant power type power supply with wide variable ranges of voltage and current. One unit serves as multiple units of a single range DC power supply.	 PWR Series
PWR800L	0 to 60	0 to 50	700	AC 100/200 V 13/6.5 A		
PWR1600L	0 to 60	0 to 50	1400	AC 100/200 V 26/13 A		
PAT60-133T	0 to 60	0 to 133	8000		8 kw high-capacity type	 PAT-T Series
PAT40-200T	0 to 40	0 to 200	8000			
Electronic load for discharging	Estimated output			Input	Remark	Appearance
	Voltage (V)	Current (A)	Power limit (W)			
PLZ164W	6 to 60	0 to 33	165	AC 90 to 250 V 80 VA	By adding a bias power supply, the minimum discharge voltage can be lowered. For details, please contact with us.	 PLZ-4W Series
PLZ334W	8 to 60	0 to 50	330	AC 90 to 250 V 90 VA		
PLZ1004W	8 to 60	0 to 50	1000	AC 90 to 250 V 90 VA		
PLZ2004WB	8 to 60	0 to 50	2000	AC 90 to 250 V 200 VA		
PLZ164WA	4.5 to 60	0 to 33	165	AC 90 to 250 V 450 VA		
PLZ664WA	4.5 to 60	0 to 50	660	AC 90 to 250 V 1500 VA		

# Outline Drawing

# FOR BATTERY TEST SYSTEM PFX2500 SERIES

[PFX2511/PFX2512]

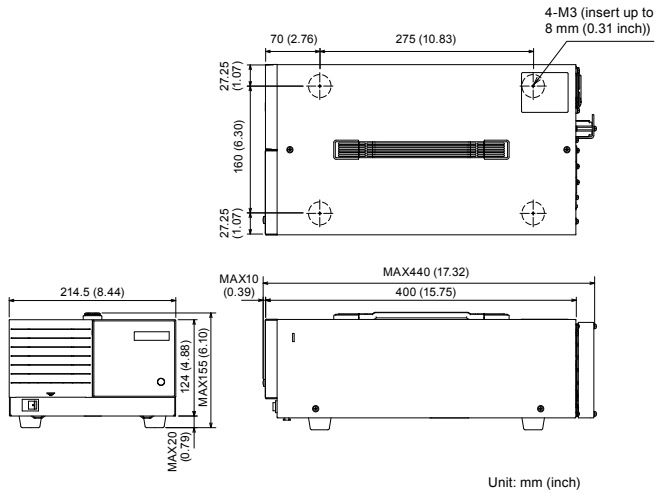

[PFX2532]

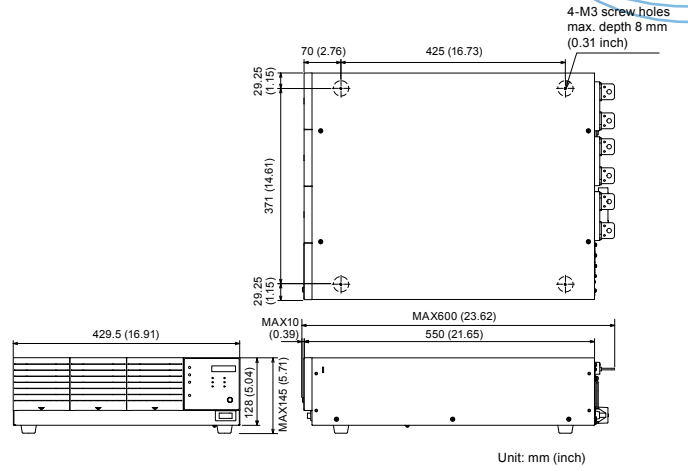

[SL01-PFX]

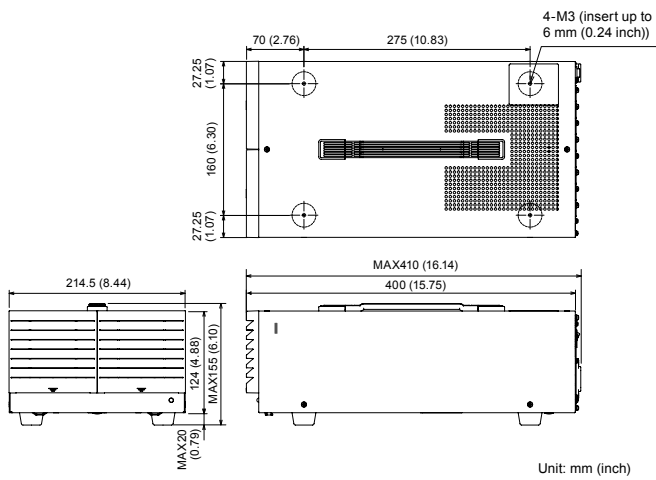

## Order Information

Model	Description	Remark
PFX2511	Charge/discharge system controller	60V/50A
PFX2512	Charge/discharge system controller	60V/50A Seamless charge/discharge
PFX2532	Charge/discharge system controller	60V/200A Seamless charge/discharge

### ■ Optional

Model	Description	PFX2511	PFX2512	PFX2532	Remark
PFX2121	Communication control unit *1	●			PFX2511 exclusive
TL08-PFX	Load cable (with voltage current, and temperatur sensing cable)	●	●		50A 5m Supplied with sensing cable. Heat resistant up to 105 °C
TL09-PFX	Sensing cable set (voltage sensing cable and thermocouple)	●	●	●	K type thermocouple for 4 cells, heat resistant up to 105°C
TL10-PFX	Cable Set			●	200A 3m(Between the PFX2532) 60cm of the connecting cables between devices.
TL11-PFX	Cell Voltage Sensing Cable Set		●	●	OP03-PFX exclusive. This product supports 8 voltage measurement points. approx. 5 m
TL12-PFX	Cell Voltage Sensing Cable Set		●	●	OP03-PFX exclusive. CE compliant product. This product supports 8 voltage measurement points. approx. 3 m
OP01-PFX	Voltage/thermometer unit	●			PFX2511 exclusive. Up to 3 boards can be mounted.
OP02-PFX	Voltage/thermometer unit		●	●	PFX2512, PFX2532 exclusive. Up to 3 boards can be mounted.
OP03-PFX	Voltage unit		●	●	SL01-PFX exclusive. Up to 8 boards can be mounted.
SL01-PFX	8Slot Unit		●	●	PFX2512, PFX2532 exclusive.
KRC363L	19 inch Cabinet rack	●	●	●	Overall height:1835mm The length for maximum surface: 950mm
KRA3	Rack adapter	●	●	●	EIA standards.
KRA150	Rack adapter	●	●	●	JIS standards.
SD002	Application software BPChecker2000 Full Edition	●			PFX2511 exclusive. The 2-channel version is supplied with PFX2511.
SD007-PFX	Application software BPChecker3000 *2		●	●	PFX2512, PFX2532 exclusive.

\*1 Essential product for the actuation of PFX2511.

\*2 Essential product for the actuation of PFX2512, PFX2532.



### KIKUSUI ELECTRONICS CORPORATION

1-1-3, Higashiyamata, Tsuzuki-ku, Yokohama, 224-0023, Japan  
Phone: (+81) 45-593-7570, Facsimile: (+81) 45-593-7571, www.kikusui.co.jp

**KIKUSUI AMERICA, INC. 1-877-876-2807** [www.kikusuiamerica.com](http://www.kikusuiamerica.com)



2975 Bowers Avenue, Suite 307, Santa Clara, CA 95051  
Phone : 408-980-9433 Facsimile : 408-980-9409

**KIKUSUI TRADING (SHANGHAI) Co., Ltd.** [www.kikusui.cn](http://www.kikusui.cn)



Room308,Building 2, No.641,Tianshan Road, Shanghai City, China  
Phone : 021-5887-9067 Facsimile : 021-5887-9069

For our local sales distributors and representatives, please refer to "sales network" of our website.

### ●Distributor:

■ All products contained in this catalogue are equipment and devices that are premised on use under the supervision of qualified personnel, and are not designed or produced for home-use or use by general consumers. ■ Specifications, design and so forth are subject to change without prior notice to improve the quality. ■ Product names and prices are subject to change and production may be discontinued when necessary. ■ Product names, company names and brand names contained in this catalogue represent the respective registered trade name or trade mark. ■ Colors, textures and so forth of photographs shown in this catalogue may differ from actual products due to a limited fidelity in printing. ■ Although every effort has been made to provide the information as accurate as possible for this catalogue, certain details have unavoidably been omitted due to limitations in space. ■ If you find any misprints or errors in this catalogue, it would be appreciated if you would inform us. ■ Please contact our distributors to confirm specifications, price, accessories or anything that may be unclear when placing an order or concluding a purchasing agreement.

Printed in Japan

Issue: Apr.2016

2016050.SKPRIEC41